

3Roots San Diego Project
Environmental Impact Report
SCH No. 2018041065; Project No. 587128

Appendix F

Geotechnical Investigations

June 2019

**UPDATE
GEOTECHNICAL INVESTIGATION
FOR VESTING TENTATIVE MAP**

**3ROOTS
SAN DIEGO, CALIFORNIA**



GEOCON
INCORPORATED

GEOTECHNICAL
ENVIRONMENTAL
MATERIALS

PREPARED FOR

**MESA COMMUNITY PARTNERS, LLC, AND
CALATLANTIC GROUP, INC.,
A DELAWARE CORPORATION
SAN DIEGO, CALIFORNIA**

**NOVEMBER 10, 2017
PROJECT NO. G2070-42-02**



Project No. G2070-42-02
November 10, 2017

Mesa Community Partners, LLC, and
CalAtlantic Group, Inc., A Delaware Corporation
16465 Via Esprillo, Suite 150
San Diego, California 92127

Attention: Mr. Ryan Green

Subject: UPDATE GEOTECHNICAL INVESTIGATION
FOR VESTING TENTATIVE MAP
3ROOTS
SAN DIEGO, CALIFORNIA

Dear Mr. Green:

In accordance with your authorization, we have prepared this update geotechnical investigation for the Vesting Tentative Map submittal for the subject project. The property is underlain by undocumented and compacted fills, alluvium/colluvium, and the Stadium Conglomerate Formation. The accompanying report presents the results of our study and our conclusions and recommendations regarding geotechnical aspects of site development. It is our opinion, based on the results of this study, that the site is suitable for the planned improvements.

Should you have questions regarding this investigation, or if we may be of further service, please contact the undersigned at your convenience.

Very truly yours,

GEOCON INCORPORATED

Rodney C. Mikesell
GE 2533

RCM:TKR:dmc

(e-mail) Addressee



Troy K. Reist
CEG 2408



TABLE OF CONTENTS

1.	PURPOSE AND SCOPE	1
2.	SITE DESCRIPTION AND PREVIOUS GRADING.....	1
3.	PROJECT DESCRIPTION.....	3
4.	SOIL AND GEOLOGIC CONDITIONS	3
4.1	Undocumented Fill (Qudf)	4
4.2	Compacted Fill (Qcf).....	4
4.3	Alluvium.....	4
4.4	Colluvium	4
4.5	Stadium Conglomerate (Tst).....	5
5.	GROUNDWATER	5
6.	GEOLOGIC HAZARDS	5
6.1	Faulting and Seismicity	5
6.2	Ground Rupture	7
6.3	Tsunamis and Seiches.....	7
6.4	Liquefaction and Seismically Induced Settlement.....	7
6.5	Landslides.....	7
6.6	Geologic Hazard Category	8
7.	EARTHWORK GRADING FACTORS.....	8
8.	CONCLUSIONS AND RECOMMENDATIONS.....	10
8.1	General.....	10
8.2	Soil and Excavation Characteristics	11
8.3	Settlement Monitoring	13
8.4	Subdrains	14
8.5	Grading Recommendations	14
8.6	Slopes.....	16
8.7	Settlement of Existing and Proposed Fills.....	17
8.8	Seismic Design Criteria.....	17
8.9	Foundations	19
8.10	Slope Maintenance.....	19
8.11	Storm Water Management.....	20
8.12	Site Drainage and Moisture Protection.....	20
8.13	Grading and Foundation Plan Review	21

LIMITATIONS AND UNIFORMITY OF CONDITIONS

MAPS AND ILLUSTRATIONS

- Figure 1, Vicinity Map
- Figure 2, Geologic Map
- Figures 3 – 7, Geologic Cross-Sections A-A' through K-K'
- Figure 8, Typical Settlement Monument
- Figure 9, Removal Limits Beyond Toe of Slopes
- Figures 10 – 12, Slope Stability Analysis

TABLE OF CONTENTS (Concluded)

APPENDIX A

FIELD INVESTIGATION

Figures A-1 – A-69, Logs of Exploratory Trenches

Figures A-70 – A-86, Logs of Large-Diameter Borings

Figures A-87 – A-94, Logs of Small-Diameter Borings

APPENDIX B

LABORATORY TESTING

Table B-I, Summary of Laboratory Maximum Dry Density and Optimum Moisture Content Test Results

Table B-II, Summary of Laboratory Expansion Index Test Results

Table B-III, Summary of Laboratory Direct Shear Test Results

Table B-IV, Summary of Laboratory Water-Soluble Sulfate Test Results

Table B-V, Summary of Laboratory Chloride Ion Content Test Results

Table B-VI, Summary of Laboratory Potential of Hydrogen (pH) and Resistivity Test Results

Figures B-1 – B-18, Consolidation Curves

APPENDIX C

STORM WATER MANAGEMENT RECOMMENDATIONS

APPENDIX D

RECOMMENDED GRADING SPECIFICATIONS

LIST OF REFERENCES

UPDATE GEOTECHNICAL INVESTIGATION

1. PURPOSE AND SCOPE

This report presents the results of our update geotechnical investigation for the Vesting Tentative Map submittal for the 3Roots project within the Lehigh Hanson Carroll Canyon aggregate mine. The project site is generally located to the east and northeast of the intersection of Camino Santa Fe and Carroll Canyon Road in the Mira Mesa area of San Diego, California (see *Vicinity Map*, Figure 1). The purpose of the geotechnical investigation was to evaluate the surface and subsurface soil and geologic conditions and provide recommendations regarding the geotechnical aspects of developing the property for residential and commercial uses, including parks and infrastructure. In addition, this report is intended to update our previous report titled *Preliminary Geotechnical Investigation for Vesting Tentative Map, 3Roots, San Diego, California*, dated August 31, 2017 (Project No. G2070-42-01).

The scope of our recent and previous studies consisted of a review of readily available published and unpublished geologic literature (see List of References), drilling 17 large-diameter borings and 8 small-diameter borings, 69 exploratory trenches, soil sampling, laboratory testing, engineering analyses, and preparation of this report. The approximate locations of the borings and trenches are shown on the *Geologic Map*, Figure 2. Our scope also included a review of our summary compaction report documenting the placement of compacted fill that has occurred during reclamation grading (Reference No. 7).

Site geologic conditions depicted on the *Geologic Map* were plotted on an AutoCAD base map provided by Project Design Consultants. The plan depicts the proposed grading, existing topography, mapped geologic contacts, base of compacted fill elevations and the approximate locations of the exploratory excavations. *Geologic Cross-Sections A-A'* through *K-K'* (Figures 3 through 7) represent our interpretation of the geologic conditions across the site.

The conclusions and recommendations presented herein are based on our analysis of the data obtained from the exploratory field investigations, laboratory test results, review of compaction reports associated with reclamation grading which has occurred on the property, and our experience with similar soil and geologic conditions on this and adjacent properties.

2. SITE DESCRIPTION AND PREVIOUS GRADING

The project site consists of approximately 427 acres of partially graded and ungraded land located within the Lehigh Hanson aggregate mine area located in San Diego, California. The property has been utilized to mine aggregate (predominately the cobble from the Stadium Conglomerate formation) to produce sand and aggregate products since the early 1950's. Recently, active mining

has ceased; however, a concrete batch plant and other tenants occupy portions of the property. Many of the conveyor belts and equipment along with numerous stockpiles of soil, aggregate, and recycled products are still present on the property. We understand equipment and other structures are currently being removed from the site.

Mining resulted in removal of rock and soil deposits resulting in deep excavations (over 100 feet), as well as relatively steep cut slopes (0.4:1 horizontal to vertical) within the northern portion of the property. The excavations were backfilled with waste materials generated during mining activities that have created relatively sharp differential fill thicknesses with abrupt near-vertical formational sidewall contacts.

Compaction testing has been performed by Geocon Incorporated on a periodic basis on the waste materials placed throughout the site from December 1979 through March 2016. Compaction reports were prepared on an approximate quarterly to annual basis during fill placement. These reports were recently summarized into our report titled *Compaction Test Summary Report, Hanson Carroll Canyon Materials Plant, San Diego, California*, dated April 14, 2017. The summary report includes the previously submitted compaction test reports and approximate locations of the density tests taken.

Recently, minor grading occurred in Area 5 (shown as light blue shaded area on Figure 2), located within the central portion of the site. The grading consisted of removal of saturated fill to expose the native formational bedrock contact (Stadium Conglomerate) and placement of compacted fill. Compaction tests in this area will be summarized in a future report.

Fill depths are estimated to range from approximately 50 feet to 150 feet within the northwest portion of the property. Some of the fill is comprised of stockpiles (shown as green shaded areas on Figure 2) and a large undocumented fill berm (also shaded green) constructed along the northern property boundary. The stockpiles and most of the undocumented fill berm will be removed to reach proposed pad grades resulting in fill depths between 50 to 100.

Compacted fill was also placed during the reclamation grading operations along the southern portion of the site. The compacted fill is expected to range from between 20 and 80 feet thick, however, it is overlain by undocumented fill and stockpiles approximately 5 to 10 feet thick. At the east end of the property approximately 20 to 30 feet of compacted fill was also placed, which is overlain by up to 70 feet of undocumented fill.

In the southeast and central portion of the site, previous waste ponds were infilled with undocumented fill (shown as light brown shaded areas on Figure 2). The undocumented fill was placed directly on compressible deposits that had accumulated in the pond areas, which will require complete removal prior to placement of additional fill, improvements, or structural loads.

Areas located outside where reclamation grading operations were performed consist of compressible surficial deposits (i.e. undocumented fill, alluvium, colluvium) that will require remedial grading. The perimeter slopes to the north and south beyond the mined pit areas consist of native slopes.

A trunk sewer main currently traverses the site (shown in green on Figure 2). We expect portions of the sewer main may be left in-place and will need to be protected during grading. Other utility lines (high pressure gas line, electric, water) that serve the existing tenants on the property and former mining activities exist across the property. We expect many of these utilities will be abandoned and relocated.

3. PROJECT DESCRIPTION

Based on planned finish grades, grading will consist of excavations up to approximately 80 feet with fills up to approximately 90 feet to achieve the current desired grades, which will support approximately 1,800 residential units, mixed-use areas, parks, and infrastructure.

It is our understanding that the residential portion of the project will be comprised of both single-family attached and detached products along with multi-family and affordable housing units. The planned mixed-use component is expected to consist of retail and office space with a mobility hub proposed for the project.

Across the southern portion of the site a 25-acre community park is planned. In addition, several passive parks will be constructed within the property. Carroll Canyon Road (a 6-lane prime arterial roadway) will be extended from the current terminus west of Camino Ruiz to Camino Santa Fe. The project will also restore Carroll Canyon Creek by constructing drainage features that include a drainage channel, drop structures, and an arch undercrossing below Carroll Canyon Road. A pedestrian bridge across the creek drainage is also planned. Storm water management will be handled with regional basins planned at various locations on the property.

The locations and descriptions provided herein are based on a review of available information and plans prepared by Project Design Consultants. If project details change significantly from those described herein, Geocon Incorporated should be contacted to evaluate potential impacts with respect to the site soil and geologic conditions and to determine if the proposed changes will require revision of this report.

4. SOIL AND GEOLOGIC CONDITIONS

The site is underlain by undocumented fill, stockpiles of soil, aggregate and asphalt products, compacted fill, alluvium, colluvium, and the Stadium Conglomerate Formation. The soil and geologic units are described below. The approximate lateral extent of surficial soils and geologic formational

units are shown on the *Geologic Map. Geologic Cross-Sections A-A'* through *K-K'* (Figures 3 through 7) represent our interpretation of the geologic conditions across the site.

4.1 Undocumented Fill (Qudf)

Undocumented fill associated with previous mining and grading activities is present across the majority of the site. The undocumented fill thickness is expected to range from a few feet to 80 feet thick. The thicker undocumented fills exist in the northwest and east corners of the property; however, the majority of these deposits will be removed based on the current proposed pad grades. In some areas, we expect up to 5 to 10 feet of undocumented fill may exist below finish pad grade, which will require removal and recompaction.

Along the south portion of the site, finish grades are currently planned above the current grades. Prior to placing fill, the undocumented fill will need to be removed and replaced within building pads and roadway areas. Undocumented fill underlying the community park will require partial removals in non-structural areas. However, any park improvements such as buildings and parking lots will require remedial measures. Additionally, the infilled pond areas, (shown as light brown shaded areas on Figure 2), will require complete removal.

4.2 Compacted Fill (Qcf)

Compacted fill placed during reclamation grading is present within the northwest, southern, and eastern portions of the site. The compacted fill was tested during placement periodically by Geocon Incorporated (see Reference No. 7). Based on exploratory borings and laboratory testing performed for this study, the compacted fill has a low potential for loading-induced compression, and has good moisture content and density. The compacted fill is considered suitable for support of planned improvements in its existing condition. Prior to placing fill, the upper 12 inches of compacted fill should be reprocessed by scarifying, moisture conditioning and recompacting prior to placing additional fill or structural improvements.

4.3 Alluvium

Alluvium is present within the drainage areas along the northern project perimeter and within the southern portion (Carroll Canyon Creek) of the site. The alluvium where observed, consists of sand, silts and clays with varying amounts of cobble. The alluvium is considered compressible and should be removed and replaced as compacted fill within structural improvement areas.

4.4 Colluvium

Colluvium was encountered at the base and along the natural hillside at the east end of the property. The colluvium consists of loose, sandy clay with gravel and cobbles. The thickness of the colluvium

was undetermined due to caving. The colluvium is compressible and will require removal within structural improvement areas.

4.5 Stadium Conglomerate (Tst)

The Eocene-age Stadium Conglomerate is the predominant formational unit on the site. This unit was the primary material mined to generate aggregate. In general, the Stadium Conglomerate consists of a dense to very dense, yellow to light brown, cobble conglomerate. The deposit contains a relatively high percentage of rounded cobble (up to approximately 60 percent by weight) embedded in a silty to clayey, fine to medium sand soil matrix. The cobble typically ranges in size from approximately 3 inches to 12 inches, however, boulder size clasts up to 24 inches were also encountered. The Stadium Conglomerate underlies the surficial soils on the property and is exposed on the north and south perimeter slopes. When excavated, the Stadium Conglomerate typically consists of *low to very low* expansive silty/clayey sands that possess good shear strength characteristics in either a natural or properly compacted condition. Cuts slopes within the Stadium Conglomerate typically possess adequate factors of safety. The Stadium Conglomerate is suitable for support of additional fill and structural loading.

5. GROUNDWATER

Groundwater was encountered in several borings and trenches throughout the project, which appears to be perched on the underlying Stadium Conglomerate. It is expected that groundwater will be encountered during remedial grading operations within the southern portion of the property, which may require temporary dewatering techniques. It is not uncommon for groundwater or seepage conditions to develop where none previously existed. Groundwater elevations are dependent on seasonal precipitation, irrigation, land use, among other factors, and vary as a result. Proper surface drainage will be important to future performance of the project.

6. GEOLOGIC HAZARDS

6.1 Faulting and Seismicity

Based on a review of geologic literature and experience with the soil and geologic conditions in the general area, it is our opinion that no known active or potentially active faults are located at the site.

Minor fault traces have been mapped with the northern portion of the site that traverse generally from east to west. The faults were observed during grading of the adjacent Fenton Technology Park project and during the recent mining operations. Undisturbed ferruginous mineral layers caused by long periods of weathering along the fault trace were observed along the faults. These layers are suggestive of ancient (pre-Holocene) pervasive groundwater conditions. The faults also due not

extend through the Quaternary units observed on site. Based on these characteristics the faults are considered inactive.

According to the computer program *EZ-FRISK* (Version 7.65), six known active faults are located within a search radius of 50 miles from the property. The nearest known active fault is the Newport-Inglewood/Rose Canyon Fault Zone, located approximately 6 miles west of the site. The Newport-Inglewood/Rose Canyon Fault Zone is the dominant source of potential ground motion. Earthquakes that might occur on the Newport-Inglewood/Rose Canyon Fault Zone or other faults within the southern California and northern Baja California area are potential generators of significant ground motion at the site. The estimated deterministic maximum earthquake magnitude and peak ground acceleration for the Newport-Inglewood/Rose Canyon Fault Zone are 7.5 and 0.36g, respectively. Table 6.1.1 lists the estimated maximum earthquake magnitude and peak ground acceleration for the most dominant faults in relationship to the site location. We calculated peak ground acceleration (PGA) using Boore-Atkinson (2008) NGA USGS 2008, Campbell-Bozorgnia (2008) NGA USGS 2008, and Chiou-Youngs (2007) NGA USGS 2008 acceleration-attenuation relationships.

**TABLE 6.1.1
DETERMINISTIC SPECTRA SITE PARAMETERS**

Fault Name	Distance from Site (miles)	Maximum Earthquake Magnitude (Mw)	Peak Ground Acceleration		
			Boore-Atkinson 2008 (g)	Campbell-Bozorgnia 2008 (g)	Chiou-Youngs 2007 (g)
Newport-Inglewood/Rose Canyon	6	7.5	0.31	0.28	0.36
Rose Canyon	6	6.9	0.27	0.26	0.30
Coronado Bank	20	7.4	0.19	0.13	0.16
Palos Verdes Connected	20	7.7	0.21	0.14	0.19
Elsinore	32	7.85	0.17	0.11	0.14
Earthquake Valley	39	6.8	0.10	0.06	0.06

We used the computer program *EZ-FRISK* to perform a probabilistic seismic hazard analysis. The computer program *EZ-FRISK* operates under the assumption that the occurrence rate of earthquakes on each mapped Quaternary fault is proportional to the fault slip rate. The program accounts for earthquake magnitude as a function of fault rupture length. Site acceleration estimates are made using the earthquake magnitude and distance from the site to the rupture zone. The program also accounts for uncertainty in each of following: (1) earthquake magnitude, (2) rupture length for a given magnitude, (3) location of the rupture zone, (4) maximum possible magnitude of a given earthquake, and (5) acceleration at the site from a given earthquake along each fault. By calculating the expected accelerations from considered earthquake sources, the program calculates the total average annual

expected number of occurrences of site acceleration greater than a specified value. We utilized acceleration-attenuation relationships suggested by Boore-Atkinson (2008), Campbell-Bozorgnia (2008), and Chiou-Youngs (2007) in the analysis. Table 6.1.2 presents the site-specific probabilistic seismic hazard parameters including acceleration-attenuation relationships and the probability of exceedence.

**TABLE 6.1.2
PROBABILISTIC SEISMIC HAZARD PARAMETERS**

Probability of Exceedence	Peak Ground Acceleration		
	Boore-Atkinson, 2008 (g)	Campbell-Bozorgnia, 2008 (g)	Chiou-Youngs, 2008 (g)
2% in a 50 Year Period	0.47	0.40	0.46
5% in a 50 Year Period	0.34	0.29	0.33
10% in a 50 Year Period	0.26	0.22	0.24

While listing peak accelerations is useful for comparison of potential effects of fault activity in a region, other considerations are important in seismic design, including frequency and duration of motion and soil conditions underlying the site. Seismic design of the structures should be evaluated in accordance with the California Building Code (CBC) guidelines.

6.2 Ground Rupture

The risk associated with ground rupture hazard is very low due to the absence of active faults at the subject site.

6.3 Tsunamis and Seiches

The site is not located near the ocean or downstream of any large bodies of water. Therefore, the risk of tsunamis or seiches associated with the site is low.

6.4 Liquefaction and Seismically Induced Settlement

Provided removal and recompaction of undocumented fill and alluvium is performed as recommended in this report, the risk associated with soil liquefaction hazard at the site is low.

6.5 Landslides

Based on our review of published geologic maps for the site vicinity, it is our opinion landslides are not present at the property or at a location that could impact the site.

6.6 Geologic Hazard Category

Review of the 2008 *City of San Diego Seismic Safety Study, Geologic Hazards and Faults, Sheet 35*, indicates the site is mapped as Geologic Hazard Categories 51, 53, and 32. Category 51 is described as- *level mesas – underlain by terrace deposits and bedrock, nominal risk*. Category 53 is described as-*level or sloping terrain, unfavorable geologic structure, low to moderate risk*. Category 32 listed under liquefaction is described as- *low potential – fluctuating groundwater, minor drainages*.

At the completion of grading, the site will be underlain by compacted fill overlying the Stadium Conglomerate Formation in structural improvement areas. The natural hillsides and cut slopes to the north and south consist of Stadium Conglomerate and are considered grossly stable.

7. EARTHWORK GRADING FACTORS

Estimates of embankment shrink or swell (bulk/shrink) factors are presented in Table 7 below. A discussion of these factors, and the level of accuracy associated with these estimates, is warranted. Bulk/shrink factors are based on comparing existing soil or rock conditions with expected final fill conditions. Numerous uncertainties are inherent with the analysis and its potential effect on site development costs should be considered when preparing budgets. Variations in natural soil density, as well as in compacted fill, render shrinkage and bulking value estimates very approximate.

For the existing conditions, the density (and moisture content) can vary by 10 to 20 percent. The geometry of differing soil deposits can vary significantly over relatively short distances. The depth and variability of the gravel, cobble, and boulder content can also vary abruptly over short distances. Due to these inherent inaccuracies in estimating bulk/shrink volumes, it is recommended that a site balance area be provided where grades can be adjusted to accommodate these uncertainties.

For fill areas, the degree of compaction that is achieved by the grading contractor may be significantly greater than the minimum required. As an example, the contractor can compact fills to any relative compaction of 90 percent or higher of the laboratory maximum dry density. Thus, the contractor has at least a 10 percent range of control over the fill volume. Overexcavation of the gravel-sand soils to generate capping material often occurs to facilitate the grading contractor's operation. The grading contractor can also undercut/overexcavate areas for *convenience yardage*.

Estimated ranges for percentage of shrinkage or bulking are presented in Table 7. For use in earthwork balancing, the midpoint (average) of these ranges is typically used in determining shrinkage and bulking amounts, and in balancing cut and fill volumes on the site. However, in addition to the use of the average shrinkage/bulking for balancing purposes, it is recommended that the upper and lower bounds of the earthwork factor ranges be used to *bracket* the range of estimated earthwork shrinkage and bulking. By using the upper and lower bounds, an estimate of the maximum

deviation of earthwork quantities may be established. The resulting maximum deviation is for inherent errors relating to the variability in earthwork factors and does not include an allowance for variables that occur during construction such as site grading errors, or the other factors discussed above. In this regard, it is suggested that maximum and minimum values also be assigned to other quantity estimates to permit a *worst-case* and *best-case* evaluation of balance site development costs. In addition, a *balance area* should be implemented as part of the grading plan to adjust final grades based on the final shrinkage/bulking factors.

**TABLE 7
BULKING AND SHRINKAGE FACTORS**

Soil Unit	Shrink/Bulk Factor
Alluvium and Colluvium	8 to 12 percent shrink
Undocumented fill	10 to 15 percent shrink
Compacted fill	2 percent shrink to 2 percent bulk
Stadium Conglomerate Formation	3 to 5 percent bulk

8. CONCLUSIONS AND RECOMMENDATIONS

8.1 General

- 8.1.1 No soil or geologic conditions were observed that would preclude the development of the property as presently proposed provided that the recommendations of this report are followed.
- 8.1.2 The site is underlain by undocumented fill, stockpiles, compacted fill, alluvium and the Stadium Conglomerate formation. The undocumented fill and compacted fill ranges in depths of a few feet to 150 feet. Undocumented fill, stockpile fill, alluvium and colluvium is unsuitable for support of structural improvements and should be removed and replaced as compacted fill. Areas where undocumented fill, stockpile fill, alluvium or colluvium is left in-place should be designated as non-structural.
- 8.1.3 Based on exploratory borings, trenches, and laboratory testing, the compacted fill was observed to have relatively good moisture content and density. Consolidation curves indicate the fill has a low potential for loading induced compression. The compacted fill appears to be suitable in its present condition for support of new fill and/or structural loading.
- 8.1.4 Based on our experience and laboratory testing, we expect the majority of on-site soils to possess a very low to medium expansion potential. We also expect the soils to have a negligible sulfate exposure to concrete structures.
- 8.1.5 The soils are expected to be corrosive to buried metal. The corrosive nature of the soils should be considered in the design of buried metal pipes and underground structures.
- 8.1.6 We encountered groundwater in several of the borings and trenches. We expect removal excavations along the southern portion of the property will encounter groundwater perched on the Stadium Conglomerate. Dewatering methods and possible top-loading techniques may be needed to achieve removals.
- 8.1.7 With the exception of possible strong seismic shaking, no significant geologic hazards were observed or are known to exist on the site that would adversely affect the site. No special seismic design considerations, other than those recommended herein, are required.
- 8.1.8 Subsurface conditions observed may be extrapolated to reflect general soil/geologic conditions; however, some variations in subsurface conditions between trench and boring locations should be anticipated.

8.2 Soil and Excavation Characteristics

- 8.2.1 Excavation of the surficial soils should be possible with moderate to heavy effort using conventional heavy-duty equipment. Excavation of the Stadium Conglomerate may require very heavy effort with conventional heavy-duty grading equipment to excavate and may generate oversized material. Oversized rock (rocks greater than 12 inches in dimension) can be incorporated into deep fill areas.
- 8.2.2 Temporary slopes should be made in conformance with OSHA requirements. The Stadium Conglomerate can be considered Type A Soil (Type B where groundwater or seepage is encountered) in accordance with OSHA requirements. Compacted fill can be considered Type B soil (Type C where seepage is encountered). Undocumented fill, alluvium, and colluvium should be considered Type C soil.
- 8.2.3 It is the responsibility of the contractor to provide a safe excavation during the construction of the proposed project. In general, no special shoring requirement will be necessary if temporary excavations will be less than 4 feet high. Temporary excavations greater than 4 feet high should be laid back at an appropriate inclination. Surcharge loads should not be permitted within a distance equal to the height of the excavation from the top of the excavation. The top of the excavation should be at least 15 feet from the edge of existing improvements. Excavations steeper than those recommended or closer than 15 feet from an existing surface improvement should be shored in accordance with applicable OSHA codes and regulations.
- 8.2.4 Table 8.2.1 presents the allowable slope inclination for different soil types based on information presented by OSHA assuming seepage is not encountered.

**TABLE 8.2.1
ALLOWABLE SLOPE INCLINATIONS FOR EXCAVATIONS
LESS THAN 20 FEET FOR UNDERGROUND CONTRACTORS**

Soil or Rock Type	On-Site Geologic Unit	Maximum Inclination (horizontal: vertical)	Maximum Slope Angle from Horizontal (degrees)
Type A	Stadium Conglomerate	¾:1	53
Type B	Properly Compacted Fill	1:1	45
Type C	Undocumented Fill and Surficial Soil	1½:1	34

- 8.2.5 The soil encountered in the field investigation is considered to be both “non-expansive” (expansion index [EI] of 20 or less) and “expansive” (EI greater than 20) as defined by 2016

California Building Code (CBC) Section 1803.5.3. Table 8.2.2 presents soil classifications based on the expansion index. Based on the laboratory test results, a majority of the soil encountered is expected to possess a “very low” to “medium” expansion potential.

**TABLE 8.2.2
EXPANSION CLASSIFICATION BASED ON EXPANSION INDEX**

Expansion Index (EI)	Expansion Classification	2016 CBC Expansion Classification
0 – 20	Very Low	Non-Expansive
21 – 50	Low	Expansive
51 – 90	Medium	
91 – 130	High	
Greater Than 130	Very High	

8.2.6 We performed laboratory tests on samples of the site materials to evaluate the percentage of water-soluble sulfate content. Results from laboratory testing indicate the on-site soils possess “Not Applicable” (“S0”) sulfate exposure to concrete structures as defined by 2016 CBC Section 1904 and ACI 318-08 Sections 4.2 and 4.3. Table 8.2.3 presents a summary of concrete requirements set forth by 2016 CBC Section 1904 and ACI 318. Samples of near pad grade soils should be performed after the completion of grading. The presence of water-soluble sulfates is not a visually discernible characteristic; therefore, other soil samples from the site could yield different concentrations. Additionally, over time landscaping activities (i.e., addition of fertilizers and other soil nutrients) may affect the concentration.

**TABLE 8.2.3
REQUIREMENTS FOR CONCRETE EXPOSED TO
SULFATE-CONTAINING SOLUTIONS**

Sulfate Exposure	Exposure Class	Water-Soluble Sulfate Percent by Weight	Cement Type	Maximum Water to Cement Ratio by Weight	Minimum Compressive Strength (psi)
Not Applicable	S0	0.00-0.10	--	--	2,500
Moderate	S1	0.10-0.20	II	0.50	4,000
Severe	S2	0.20-2.00	V	0.45	4,500
Very Severe	S3	> 2.00	V+Pozzolan or Slag	0.45	4,500

8.2.7 Based on our experience with the on-site soils, we expect the soils to be corrosive to buried metal. The corrosive nature of the soils should be considered in the design of buried metal

pipes and underground structures. We performed laboratory tests on samples of selected samples to check the corrosion potential. A site is considered corrosive if the chloride concentration is 500 parts per million (ppm) or greater, sulfate concentration is 2,000 ppm (0.2%) or greater, or the pH is 5.5 or less according to Caltrans *Corrosion Guidelines*, dated September 2003. The laboratory test results are presented in Appendix B. Based on the laboratory test results and guidelines listed above, it is our opinion the site is considered corrosive with respect to buried metals.

- 8.2.8 Geocon Incorporated does not practice in the field of corrosion engineering; therefore, further evaluation by a corrosion engineer may be needed to incorporate the necessary precautions to avoid premature corrosion of underground pipes and buried metal in direct contact with soil.

8.3 Settlement Monitoring

- 8.3.1 Based on the proposed grading, the majority of the northwest portion of the site will require cuts to achieve pad grade. In the central portion of the site, fills between approximately 50 to 80 feet are planned. Along the southern portion of the property, proposed grading will result in additional fill thicknesses of approximately 10 to 20 feet above existing grades. We recommend settlement monuments be placed in areas where new fill thickness (fill plus remedial removals) exceeds 50 feet. The locations of monuments will be determined once 40-scale grading plans are available.
- 8.3.2 Remedial grading recommendations provided herein specify removal and compaction of undocumented fill, alluvium, and colluvium. As such, adverse settlement associated with compressible deposits will be mitigated where these soils are completely removed. Where groundwater is present, removal of the surficial soils may be limited. Where complete removals cannot be performed, settlement monitoring as discussed herein may be required. Recommendations for settlement monitoring for these conditions, if they are present, can be provided during grading
- 8.3.3 Figure 8 shows a typical settlement monument. We recommend surface settlement monuments be installed and monitored until the readings indicate settlement, as a result of fill placement, is essentially complete. Settlement monuments should be surveyed on a weekly basis. We estimate a settlement period of 3 to 6 months. The surveyed results should be provided to Geocon Incorporated to evaluate when settlement has essentially ceased.

8.4 Subdrains

8.4.1 Canyon subdrains are not required for the project.

8.5 Grading Recommendations

8.5.1 All grading should be performed in accordance with the *Recommended Grading Specifications* contained in Appendix D. Where the recommendations of this section conflict with those of Appendix D, **the recommendations of this section take precedence**. All earthwork should be observed and all fill tested for proper compaction by Geocon Incorporated.

8.5.2 Prior to commencing grading, a preconstruction conference should be held at the site with the owner or developer, grading contractor, civil engineer, City of San Diego representatives, and geotechnical engineer in attendance. Special soil handling and/or the grading plans can be discussed at that time.

8.5.3 Site preparation should begin with the removal of all deleterious material and vegetation. The depth of removal should be such that material exposed in cut and fill areas, or soils to be used as fill are relatively free of organic matter. Material generated during stripping should be exported from the site.

8.5.4 All compressible soil deposits, including undocumented fill, stockpiles, alluvium and colluvium within areas where structural improvements and/or structural fill are planned should be removed to expose the underlying Stadium Conglomerate or compacted fill prior to placing additional fill and/or structural loads. The actual extent of unsuitable soil removals will be determined in the field during grading by the geotechnical engineer and/or engineering geologist. Areas where undocumented fill, alluvium, or colluvium will be left in-place should be identified as non-structural areas.

8.5.5 The upper surface elevation of documented compacted fill was not surveyed during reclamation grading. As such, the elevation at the top of documented fill is unknown. However, the estimated contact between documented and undocumented fill based on information from borings and trenches, and elevations from previous compaction testing is shown on the *Geologic Cross Sections*. For preliminary estimates, within areas of documented compacted fill, the upper 5 feet of fill below proposed finish grade in cut and fill areas should be removed and recompacted in all structural improvement areas. Further evaluation and testing of the fill material will be performed during grading to determine the actual extent of remedial grading necessary for these areas.

- 8.5.6 In areas outside of the limits of documented compacted fill where structural improvements will be constructed, all compressible surficial deposits should be removed to expose the underlying native Stadium Conglomerate bedrock and replaced as compacted fill. The approximate elevation of the bedrock contact and approximate thickness of remedial grading at boring and trench locations is shown on Figure 2. The estimated contacts are shown on the *Geologic Cross Sections* based on interpolation between the exploratory borings and trenches.
- 8.5.7 For the community park site along the south side of the project, we recommend at a minimum that the upper 5 feet of soil below existing grade in fill areas or 5 feet below finish grade in cut areas be removed and replaced as compacted fill. The park should be designated as nonstructural. Modified grading recommendations to provide engineered fill for support of structural improvements in the park can be provided in update reports once the location and type of structural improvement for the park is known.
- 8.5.8 In the pond areas where uncompacted fill was placed over compressible pond deposits (shown as light brown shaded area on Figure 2), we expect significant settlement will occur. Therefore, complete removal of the compressible deposits will be required in these areas.
- 8.5.9 Removals within drainage areas and near toes of proposed fill slopes should extend horizontally beyond the edge of improvements a distance equal to the depth of removal. A typical detail of remedial grading beyond proposed grading is presented in Figure 9. The anticipated removal limits are shown in green on the *Geologic Map* and *Geologic Cross Sections*. Structural setbacks or modified recommendations may be required if remedial removals cannot extend laterally as recommended due to environmental constraints, especially along Carroll Canyon Creek.
- 8.5.10 Cut to fill transitions may occur as a result of grading within portions of the property. Additionally, lots with very large differential fill thicknesses will exist near the previous mined cut slope sidewall in the northwest portion of the property. To reduce the amount of differential settlement, building pads and lots should be undercut at least 3 feet and sloped 1 percent to the adjacent street or deepest fill. Where the thickness of the fill below the building pad or lot exceeds 15 feet, the depth of the undercut should be increased to one-fifth of the maximum fill thickness. Lots requiring undercuts can be determined once 40-scale grading plans have been prepared.
- 8.5.11 Prior to placing fill, the base of excavations and surface of compacted fill should be scarified; moisture conditioned as necessary and compacted. Fill soils may then be placed

and compacted in layers to the design finish grade elevations. In general, on-site soils are suitable for re-use as fill if free from vegetation, debris and other deleterious material. Layers of fill should be no thicker than will allow for adequate bonding and compaction. All fill, including scarified ground surfaces and backfill, should be compacted to at least 90 percent of laboratory maximum dry density as determined by ASTM Test Procedure D 1557 at or slightly above optimum moisture content. Overly wet materials will require drying and/or mixing with drier soils to facilitate proper compaction.

- 8.5.12 The upper 3 feet of fill on all lots and streets should be composed of properly compacted *very low* to *low* expansive soils. Highly expansive soils, if encountered, should be placed in deeper fill areas and properly compacted. *Very low* to *low* expansive soils are defined as those soils that have an Expansion Index of 50 or less. Boulders, concretions, concrete chunks greater than 12 inches in maximum dimension should not be placed within 5 feet of finish grade or 3 feet from the deepest utility within streets. Specific recommendations for the placement of oversize rock is contained in the *Grading Specifications* contained in Appendix D.
- 8.5.13 Import fill (if necessary) should consist of granular materials with a *very low* to *low* expansion potential (EI of 50 or less), be free of deleterious material or stones larger than 3 inches, and should be compacted as recommended herein. Geocon Incorporated should be notified of the import soil source and should be authorized to perform laboratory testing of import soil prior to its arrival at the site to evaluate its suitability as fill material.

8.6 Slopes

- 8.6.1 Slope stability analyses were performed for proposed and existing cut and fill slopes for slope heights up to 100 feet (cut) and 60 feet (fill). The stability analyses were performed using simplified Janbu analysis. Our analyses utilized average drained direct shear strength parameters based on laboratory tests performed for this project and our experience with similar soils. The analyses indicate existing native perimeter slopes and proposed new cut and fill slopes will have calculated factors of safety in excess of 1.5 under static conditions for both deep-seated failure and shallow sloughing conditions. A summary of slope stability analyses is presented on Figures 10 through 12.
- 8.6.2 All cut slope excavations should be observed during grading by an engineering geologist to verify that soil and geologic conditions do not differ significantly from those anticipated.
- 8.6.3 The outer 15 feet (or a distance equal to the height of the slope, whichever is less) of fill slopes should be composed of properly compacted granular *soil* fill to reduce the potential

for surficial sloughing. All slopes should be compacted by backrolling with a loaded sheepsfoot roller at vertical intervals not to exceed 4 feet and should be track-walked at the completion of each slope such that the fill soils are uniformly compacted to at least 90 percent relative compaction to the face of the finished sloped.

- 8.6.4 All slopes should be landscaped with drought-tolerant vegetation, having variable root depths and requiring minimal landscape irrigation. In addition, all slopes should be drained and properly maintained to reduce erosion.

8.7 Settlement of Existing and Proposed Fills

- 8.7.1 Engineered fill was placed on the property between 1979 and 2017. The deepest fills are located in the northwest portion of the site in areas that will require cuts to achieve pad grade. Planned grading will result in the placement of up to approximately 80 feet of new fill in the central portion of the site with fills of approximately 10 to 30 feet in other areas. We expect post-grading settlement (hydro-compression) of properly compacted new fill with a thickness of approximately 80 feet to be between 3 to 4 inches. For fills that are approximately 10 to 30 feet thick, we expect post-grading settlement of about 1 to 2 inches. We expect the settlement will occur over 20+ years depending on the influx of rain and irrigation water into the fill mass. This settlement will likely be linear from the time the fill is placed to the end of the settlement period. We do not expect the settlement will impact proposed utilities with proposed gradients of 1 percent or greater. Foundations will need to be designed to accommodate post-construction settlement.

- 8.7.2 At the completion of grading, we expect some portions of the site will be underlain by approximately 100 feet of compacted fill that was placed during reclamation grading that has occurred over the past 15 years. With respect to post-construction settlement in areas where existing fills have been present for more than 5 years, we expect post-construction settlements as a result of hydro-compression to be on the order of 2.5 inches for fill thicknesses of approximately 100 feet.

- 8.7.3 Post-construction settlements for specific building pads and lots will be provided in update reports once grading plans have been prepared.

8.8 Seismic Design Criteria

- 8.8.1 We used the computer program *U.S. Seismic Design Maps*, provided by the USGS. Table 8.8.1 summarizes site-specific design criteria obtained from the 2016 California Building Code (CBC; Based on the 2015 International Building Code [IBC] and ASCE 7-10), Chapter 16 Structural Design, Section 1613 Earthquake Loads. The short spectral

response uses a period of 0.2 second. The building structure and improvements should be designed using a Site Class D. We evaluated the Site Class based on the discussion in Section 1613.3.2 of the 2016 CBC and Table 20.3-1 of ASCE 7-10. The values presented in Table 8.8.1 are for the risk-targeted maximum considered earthquake (MCE_R).

**TABLE 8.8.1
2016 CBC SEISMIC DESIGN PARAMETERS**

Parameter	Value	2016 CBC Reference
Site Class	D	Table 1613.5.2
Spectral Response – Class B (0.2 sec), S_S	0.971 g	Figure 1613.5(3)
Spectral Response – Class B (1 sec), S_1	0.375 g	Figure 1613.5(4)
Site Coefficient, F_a	1.111	Table 1613.5.3(1)
Site Coefficient, F_v	1.651	Table 1613.5.3(2)
Maximum Considered Earthquake Spectral Response Acceleration (0.2 sec), S_{MS}	1.080 g	Section 1613.5.3 (Eqn 16-36)
Maximum Considered Earthquake Spectral Response Acceleration – (1 sec), S_{M1}	0.618 g	Section 1613.5.3 (Eqn 16-37)
5% Damped Design Spectral Response Acceleration (0.2 sec), S_{DS}	0.720 g	Section 1613.5.4 (Eqn 16-38)
5% Damped Design Spectral Response Acceleration (1 sec), S_{D1}	0.412 g	Section 1613.5.4 (Eqn 16-39)

8.8.2 Table 8.8.2 presents additional seismic design parameters for projects located in Seismic Design Categories D through F in accordance with ASCE 7-10 for the mapped maximum considered geometric mean (MCE_G).

**TABLE 8.8.2
2016 CBC SEISMIC DESIGN PARAMETERS**

Parameter	Value	ASCE 7-10 Reference
Mapped MCE_G Peak Ground Acceleration, PGA	0.387 g	Figure 22-7
Site Coefficient, F_{PGA}	1.113	Table 11.8-1
Site Class Modified MCE_G Peak Ground Acceleration, PGA_M	0.431g	Section 11.8.3 (Eqn 11.8-1)

8.8.3 Conformance to the criteria in Tables 8.8.1 and 8.8.2 for seismic design does not constitute any kind of guarantee or assurance that significant structural damage or ground failure will not occur if a maximum level earthquake occurs. The primary goal of seismic design is to

protect life and not to avoid all damage, since such design may be economically prohibitive.

8.9 Foundations

8.9.1 We expect the site, at the completion of grading, will be suitable for the use of shallow post-tensioned or mat slab foundations. Foundation recommendations will be provided in update reports based on proposed structures and final grading plans.

8.9.2 We expect footings may be designed for an allowable soil bearing pressure of 2,000 psf (dead plus live loads). The soil bearing pressure may be increased by 300 psf and 500 psf for each additional foot of foundation width and depth, respectively, up to a maximum allowable soil bearing pressure of 4,000 psf. The allowable bearing pressure may be increased by up to one-third when considering transient loading such as those due to wind or seismic forces.

8.9.3 Foundations will need to be designed to accommodate both static settlement as a result of building loading and hydro-compression. Estimated total and differential fill settlements for specific building pads and project areas will be provided in update reports once grading plans have been prepared.

8.10 Slope Maintenance

8.10.1 Slopes that are steeper than 3:1 (horizontal:vertical) may, under conditions which are both difficult to prevent and predict, be susceptible to near surface (surficial) slope instability. The instability is typically limited to the outer three feet of a portion of the slope and usually does not directly impact the improvements on the pad areas above or below the slope. The occurrence of surficial instability is more prevalent on fill slopes and is generally preceded by a period of heavy rainfall, excessive irrigation, or the migration of subsurface seepage. The disturbance and/or loosening of the surficial soils, as might result from root growth, soil expansion, or excavation for irrigation lines and slope planting, may also be a significant contributing factor to surficial instability. It is, therefore, recommended that, to the maximum extent practical: (a) disturbed/loosened surficial soils be either removed or properly recompacted, (b) irrigation systems be periodically inspected and maintained to eliminate leaks and excessive irrigation, and (c) surface drains on and adjacent to slopes be periodically maintained to preclude ponding or erosion. It should be noted that although the incorporation of the above recommendations should reduce the potential for surficial slope instability, it will not eliminate the possibility, and, therefore, it may be necessary to rebuild or repair a portion of the project's slopes in the future.

8.11 Storm Water Management

- 8.11.1 If storm water management devices are not properly designed and constructed, there is a risk for distress to improvements and property located hydrologically down gradient or adjacent to these devices. Factors such as the amount of water being detained, its residence time, and soil permeability have an important effect on seepage transmission and the potential adverse impacts that may occur if the storm water management features are not properly designed and constructed. We have not performed a hydrogeological study at the site. If infiltration of storm water runoff into the subsurface occurs, downstream improvements may be subjected to seeps, springs, slope instability, raised groundwater, movement of foundations and slabs, or other undesirable impacts as a result of water infiltration.
- 8.11.2 We performed an infiltration study on the property. A summary of our study and storm water management recommendations are provided in Appendix C. Based on the results of our study, full and partial infiltration is considered infeasible due to the presence of deep fills and the dense nature of the Stadium Conglomerate Formation. Basins should utilize a liner to prevent infiltration from causing adverse settlement, migrating to adjacent slopes, utilities, and foundations.

8.12 Site Drainage and Moisture Protection

- 8.12.1 Adequate site drainage is critical to reduce the potential for differential soil movement, erosion and subsurface seepage. Under no circumstances should water be allowed to pond adjacent to footings. The site should be graded and maintained such that surface drainage is directed away from structures in accordance with 2016 CBC 1803.3 or other applicable standards. In addition, surface drainage should be directed away from the top of slopes into swales or other controlled drainage devices. Roof and pavement drainage should be directed into conduits that carry runoff away from the proposed structure.
- 8.12.2 In the case of basement walls or building walls retaining landscaping areas, a waterproofing system should be used on the wall and joints, and a Miradrain drainage panel (or similar) should be placed over the waterproofing. The project architect or civil engineer should provide detailed specifications on the plans for all waterproofing and drainage.
- 8.12.3 Underground utilities should be leak free. Utility and irrigation lines should be checked periodically for leaks, and detected leaks should be repaired promptly. Detrimental soil movement could occur if water is allowed to infiltrate the soil for prolonged periods of time.

8.12.4 Landscaping planters adjacent to paved areas are not recommended due to the potential for surface or irrigation water to infiltrate the pavement's subgrade and base course. We recommend that subdrains to collect excess irrigation water and transmit it to drainage structures, or impervious above-grade planter boxes be used. In addition, where landscaping is planned adjacent to the pavement, we recommend construction of a cutoff wall along the edge of the pavement that extends at least 6 inches below the bottom of the base material.

8.13 Grading and Foundation Plan Review

8.13.1 Geocon Incorporated should review the grading plans and foundation plans for the project prior to final design submittal to evaluate whether additional analyses and/or recommendations are required.

LIMITATIONS AND UNIFORMITY OF CONDITIONS

1. The firm that performed the geotechnical investigation for the project should be retained to provide testing and observation services during construction to provide continuity of geotechnical interpretation and to check that the recommendations presented for geotechnical aspects of site development are incorporated during site grading, construction of improvements, and excavation of foundations. If another geotechnical firm is selected to perform the testing and observation services during construction operations, that firm should prepare a letter indicating their intent to assume the responsibilities of project geotechnical engineer of record. A copy of the letter should be provided to the regulatory agency for their records. In addition, that firm should provide revised recommendations concerning the geotechnical aspects of the proposed development, or a written acknowledgement of their concurrence with the recommendations presented in our report. They should also perform additional analyses deemed necessary to assume the role of Geotechnical Engineer of Record.
2. The recommendations of this report pertain only to the site investigated and are based upon the assumption that the soil conditions do not deviate from those disclosed in the investigation. If any variations or undesirable conditions are encountered during construction, or if the proposed construction will differ from that anticipated herein, Geocon Incorporated should be notified so that supplemental recommendations can be given. The evaluation or identification of the potential presence of hazardous or corrosive materials was not part of the scope of services provided by Geocon Incorporated.
3. This report is issued with the understanding that it is the responsibility of the owner or his representative to ensure that the information and recommendations contained herein are brought to the attention of the architect and engineer for the project and incorporated into the plans, and the necessary steps are taken to see that the contractor and subcontractors carry out such recommendations in the field.
4. The findings of this report are valid as of the present date. However, changes in the conditions of a property can occur with the passage of time, whether they be due to natural processes or the works of man on this or adjacent properties. In addition, changes in applicable or appropriate standards may occur, whether they result from legislation or the broadening of knowledge. Accordingly, the findings of this report may be invalidated wholly or partially by changes outside our control. Therefore, this report is subject to review and should not be relied upon after a period of three years.

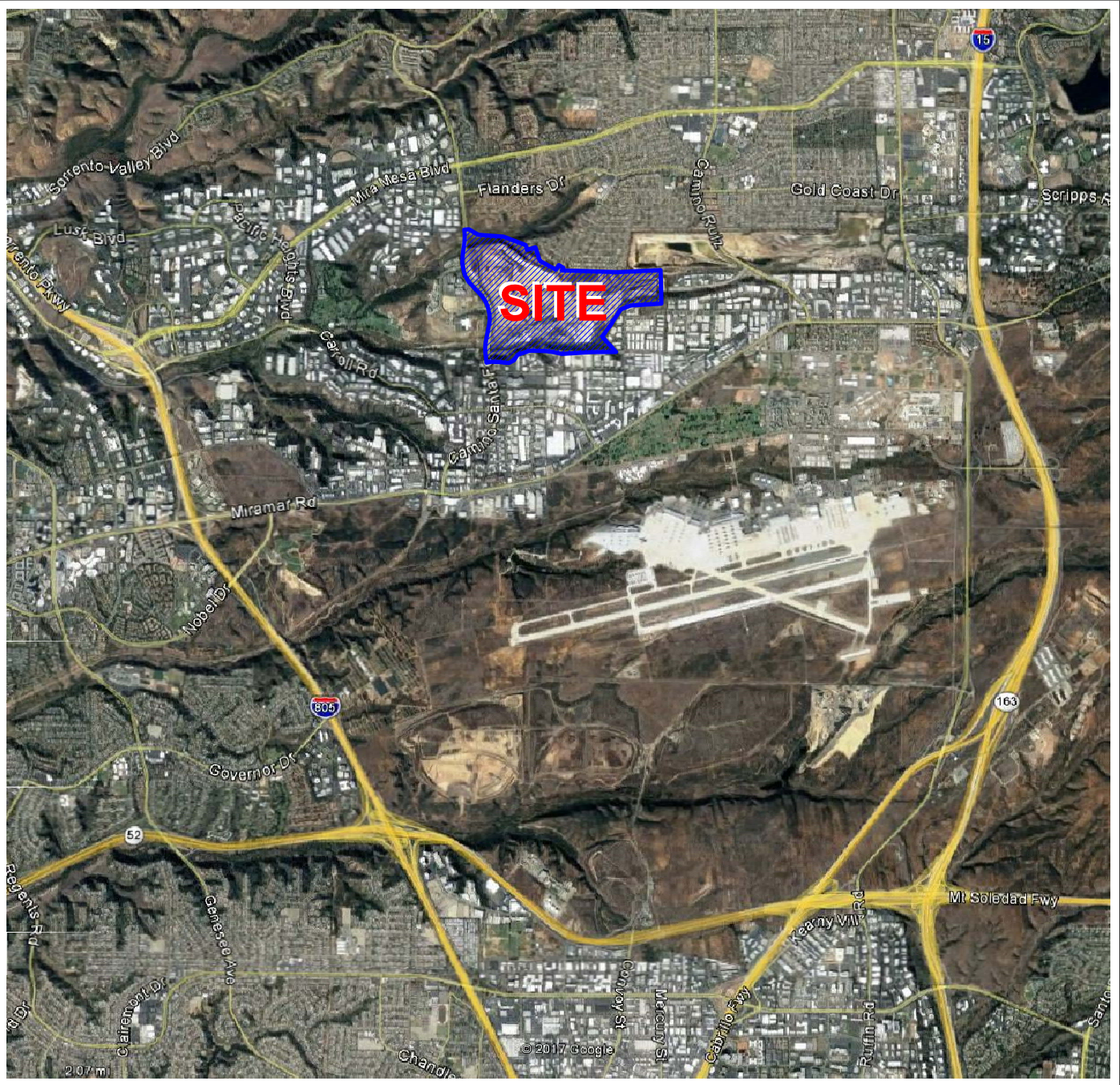

THE GEOGRAPHICAL INFORMATION MADE AVAILABLE FOR DISPLAY WAS PROVIDED BY GOOGLE EARTH, SUBJECT TO A LICENSING AGREEMENT. THE INFORMATION IS FOR ILLUSTRATIVE PURPOSES ONLY; IT IS NOT INTENDED FOR CLIENT'S USE OR RELIANCE AND SHALL NOT BE REPRODUCED BY CLIENT. CLIENT SHALL INDEMNIFY, DEFEND AND HOLD HARMLESS GEOCON FROM ANY LIABILITY INCURRED AS A RESULT OF SUCH USE OR RELIANCE BY CLIENT.



NO SCALE

VICINITY MAP

GEOCON
INCORPORATED



GEOTECHNICAL ■ ENVIRONMENTAL ■ MATERIALS
6960 FLANDERS DRIVE - SAN DIEGO, CALIFORNIA 92121 - 2974
PHONE 858 558-6900 - FAX 858 558-6159

3ROOTS
SAN DIEGO, CALIFORNIA

RM / AML	DSK/GTYPD	DATE 11 - 10 - 2017	PROJECT NO. G2070 - 42 - 02	FIG. 1
----------	-----------	---------------------	-----------------------------	--------



GEOLOGIC MAP
 3000 S. SAN DIEGO AVENUE
 SAN DIEGO, CALIFORNIA

GEOCON LEGEND

- Qudf UNCONSOLIDATED FILL
- Qcf COMPACTED FILL (SHOWN WHEN BURIED)
- Qal ALLUVIUM (SHOWN WHEN BURIED)
- Qc COLLUVIUM
- Qvop8 VERY OLD PARALIC DEPOSITS
- Tst STADIUM CONGLOMERATE (SHOWN WHEN BURIED)
- APPROX. LOCATION OF GEOLOGIC CONTACT (SHOWN WHEN BURIED, QUANTIFIED WHEN USABLE)
- APPROX. LOCATION OF LARGE DIAMETER BORING
- APPROX. LOCATION OF SMALL DIAMETER BORING
- APPROX. LOCATION OF EXPLORATORY TRENCH
- T-12 APPROX. DEPTH TO SEEPAGE/GROUNDWATER (IN FEET)
- (R2) APPROX. THICKNESS OF REMEDIAL GRADING (IN FEET)
- APPROX. ELEVATION OF CONTACT WITH STADIUM CONGLOMERATE
- APPROX. LOCATION OF INACTIVE FAULT (SHOWN WHEN BURIED, QUANTIFIED WHEN USABLE)
- APPROX. LOCATION OF INFILTRATION TEST
- APPROX. LIMITS OF UNCONSOLIDATED FILL (SHOWN PLACED IN POND AREAS)
- APPROX. LIMITS OF STOCKPILE
- APPROX. AREA OF CURRENT GRADING
- APPROX. LIMITS OF ENVIRONMENTAL SENSITIVE AREA
- APPROX. LIMITS OF REMEDIAL GRADING/DISTURBANCE
- GEOLOGIC CROSS SECTION

GRAPHIC SCALE
 0' 60' 120' 180' 240' 300' 480'
 SCALE 1"=120' (at 70x36)

DATE 11-10-2017
 PROJECT NO. G20170-42-02
 SHEET 1 OF 1

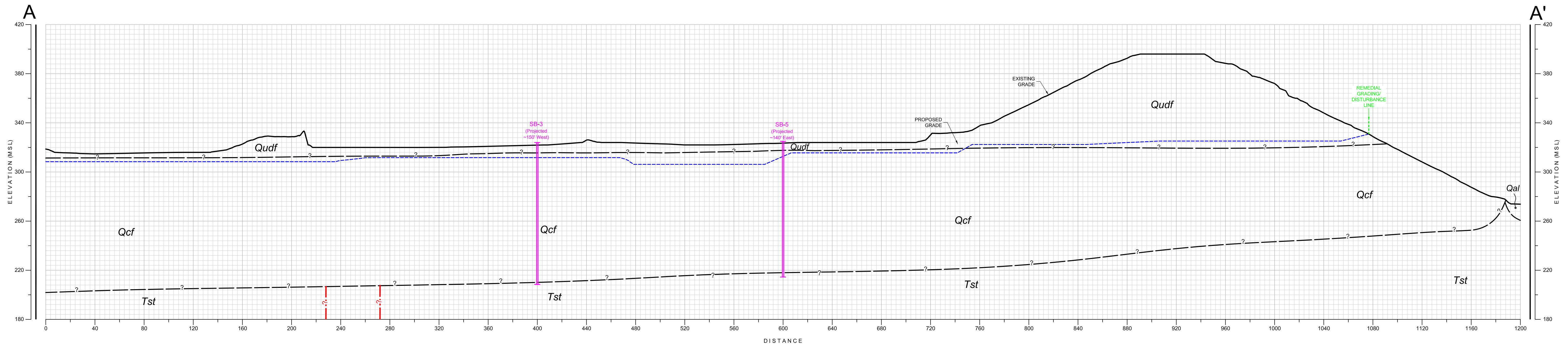

GEOLOGIC CROSS-SECTION A-A'
SCALE: 1" = 40' (Vert. = Horiz.)

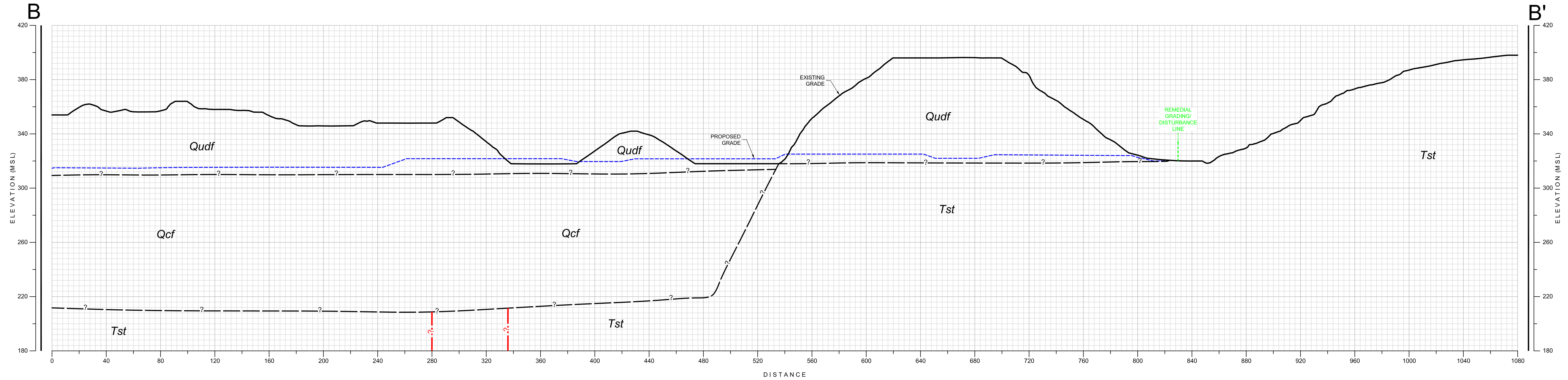

GEOLOGIC CROSS-SECTION B-B'
SCALE: 1" = 40' (Vert. = Horiz.)

- GEOCON LEGEND**
- Qudf* UNDOCUMENTED FILL
 - Qcf* COMPACTED FILL
 - Qal* ALLUVIUM
 - Qc* COLLUVIUM
 - Tst* STADIUM CONGLOMERATE
 - APPROX. LOCATION OF GEOLOGIC CONTACT (Queried Where Uncertain)
 - APPROX. LOCATION OF LARGE DIAMETER BORING
 - APPROX. LOCATION OF SMALL DIAMETER BORING
 - APPROX. LOCATION OF EXPLORATORY TRENCH
 - APPROX. LOCATION OF INACTIVE FAULT

GEOLOGIC CROSS SECTION		
3ROOTS SAN DIEGO, CALIFORNIA		
GEOCON INCORPORATED	SCALE 1" = 40'	DATE 11 - 10 - 2017
GEO TECHNICAL ■ ENVIRONMENTAL ■ MATERIALS 6940 SANDERS DRIVE - SAN DIEGO, CALIFORNIA 92121 - 2974 PHONE 858.558.6900 - FAX 858.558.6159	PROJECT NO. G2070 - 42 - 02	FIGURE 3
SHEET 1 OF 5		

P:\net\11-10-2017 11:47AM [By:ALVIN LADRELLON] | File Location: Y:\PROJECTS\G2070-42-02 (BROOK)SHEETS\G2070-42-02 3SHEET.dwg

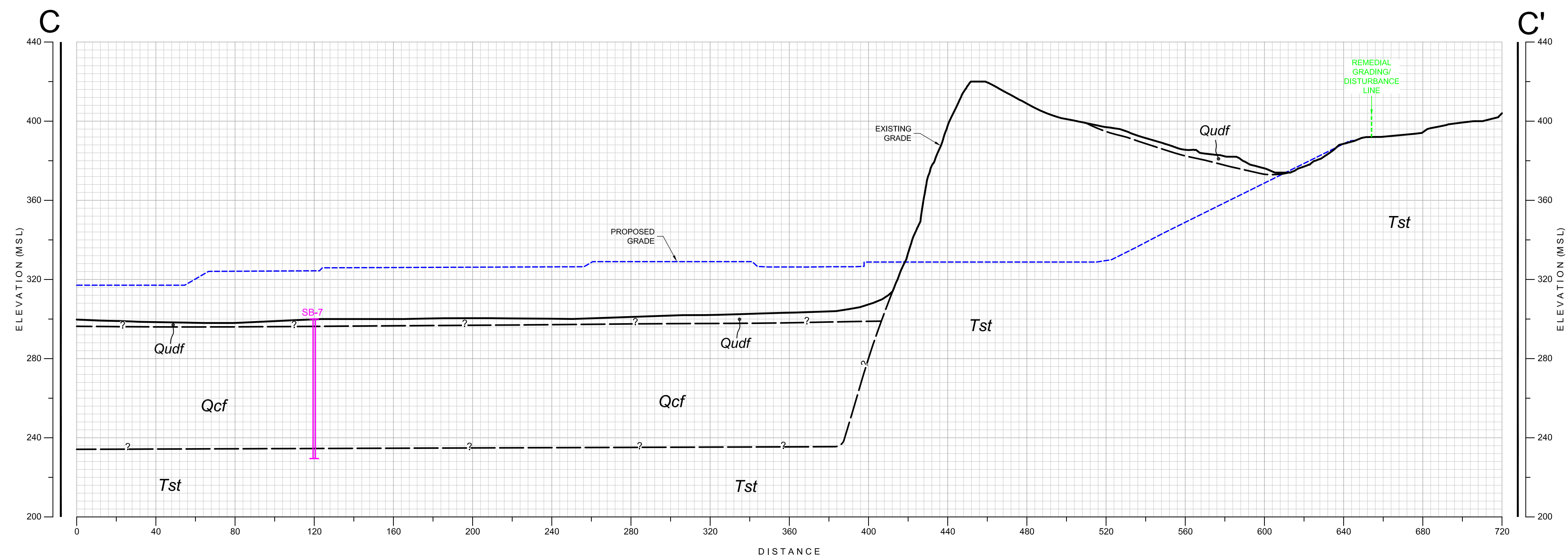

GEOLOGIC CROSS-SECTION C-C'
SCALE: 1" = 40' (Vert. = Horiz.)

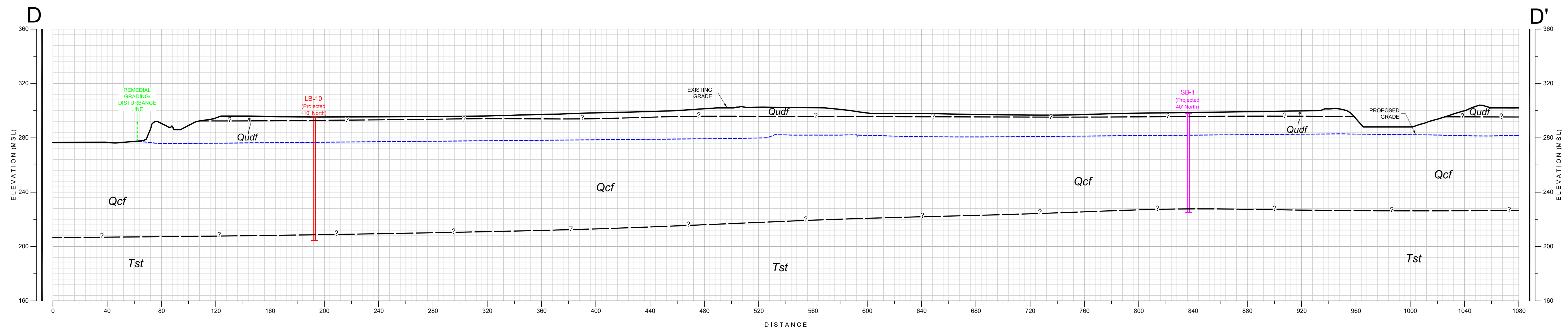

GEOLOGIC CROSS-SECTION D-D'
SCALE: 1" = 40' (Vert. = Horiz.)

- GEOCON LEGEND**
- Qudf UNDOCUMENTED FILL
 - Qcf COMPACTED FILL
 - Qal ALLUVIUM
 - Qc COLLUVIUM
 - Tst STADIUM CONGLOMERATE
 - APPROX. LOCATION OF GEOLOGIC CONTACT (Queried Where Uncertain)
 - LD-10 APPROX. LOCATION OF LARGE DIAMETER BORING
 - SB-1 APPROX. LOCATION OF SMALL DIAMETER BORING
 - T-34 APPROX. LOCATION OF EXPLORATORY TRENCH
 - APPROX. LOCATION OF INACTIVE FAULT

GEOLOGIC CROSS SECTION		
3ROOTS SAN DIEGO, CALIFORNIA		
GEOCON INCORPORATED	SCALE 1" = 40'	DATE 11 - 10 - 2017
GEO TECHNICAL ■ ENVIRONMENTAL ■ MATERIALS 6940 SANDERS DRIVE - SAN DIEGO, CALIFORNIA 92121 - 2974 PHONE 858.558-6900 - FAX 858.558-6159	PROJECT NO. G2070 - 42 - 02	FIGURE 4
SHEET 2 OF 5		

Plot: 11/14/2017 11:47AM | By: ALVIN LADRELOW | File: Location\PROJECTS\G2070-42-02 (R004)\SHEETS\G2070-42-02 2300x900 Max.dwg

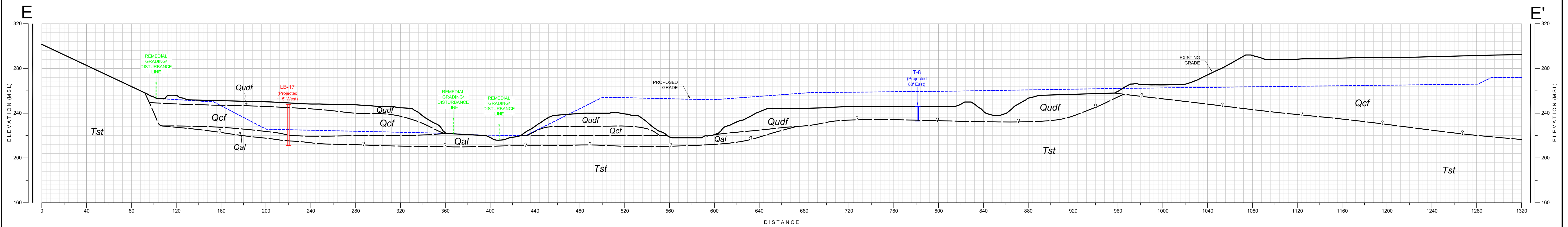

GEOLOGIC CROSS-SECTION E-E'
SCALE: 1" = 40' (Vert. = Horiz.)

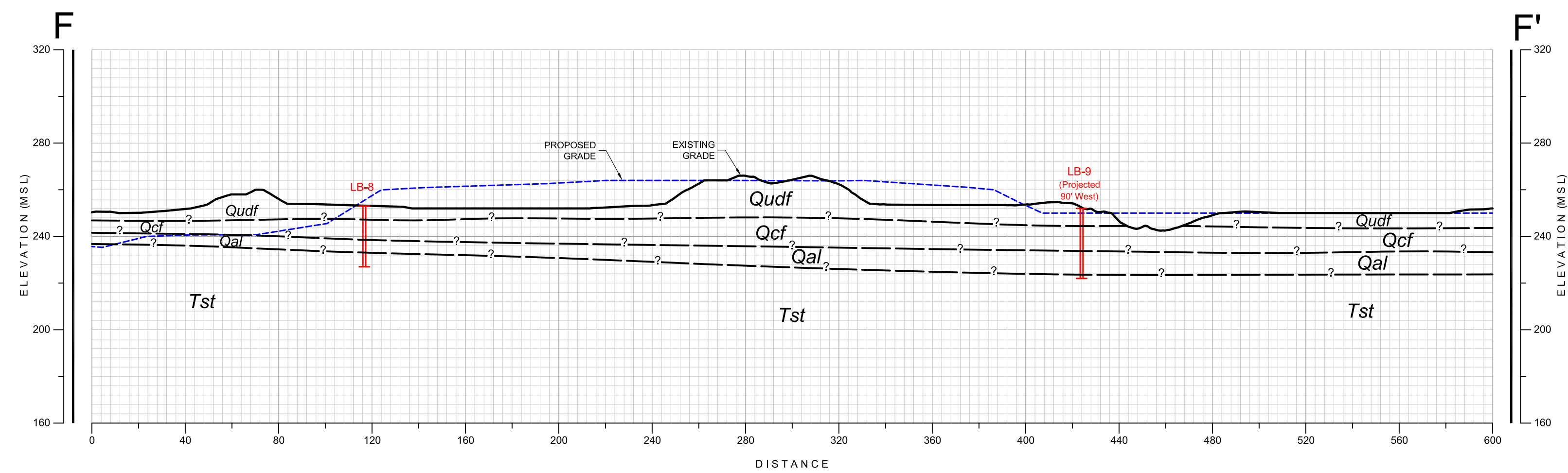

GEOLOGIC CROSS-SECTION F-F'
SCALE: 1" = 40' (Vert. = Horiz.)

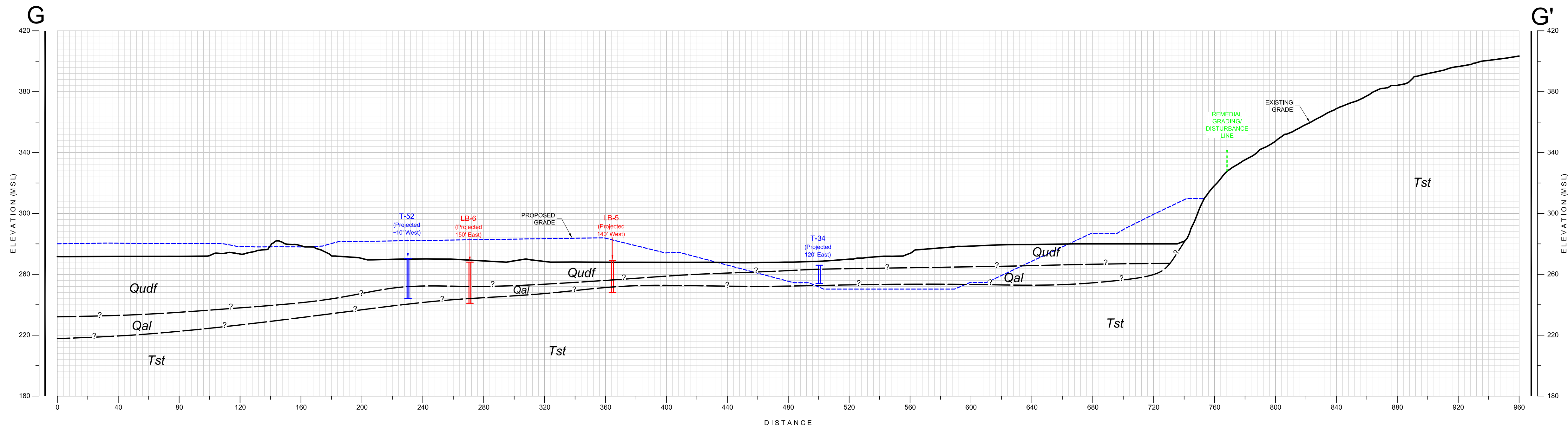

GEOLOGIC CROSS-SECTION G-G'
SCALE: 1" = 40' (Vert. = Horiz.)

- GEOCON LEGEND**
- Qudf UNDOCUMENTED FILL
 - Qcf COMPACTED FILL
 - Qal ALLUVIUM
 - Qc COLLUVIUM
 - Tst STADIUM CONGLOMERATE
 - ~ ~ ~ APPROX. LOCATION OF GEOLOGIC CONTACT (Queried Where Uncertain)
 - LB-10 APPROX. LOCATION OF LARGE DIAMETER BORING
 - SB-1 APPROX. LOCATION OF SMALL DIAMETER BORING
 - T-34 APPROX. LOCATION OF EXPLORATORY TRENCH
 - - - APPROX. LOCATION OF INACTIVE FAULT

GEOLOGIC CROSS SECTION
3ROOTS
SAN DIEGO, CALIFORNIA

<p>GEOCON INCORPORATED</p> <p>GEOTECHNICAL ■ ENVIRONMENTAL ■ MATERIALS</p> <p>6940 ANDERS DRIVE ■ SAN DIEGO, CALIFORNIA 92121-2974</p> <p>PHONE 858.558-6900 ■ FAX 858.558-6159</p>	SCALE 1" = 40'	DATE 11 - 10 - 2017	<p>FIGURE 5</p>	
	PROJECT NO. G2070 - 42 - 02			
	SHEET 3 OF 5			

Plotfile:11142017 1145AM | By:ALVIN LADRELLON | File Location:PROJECTS\G2070-42-02 (Routy)\SHEETS\G2070-42-02 3Sheet.dwg

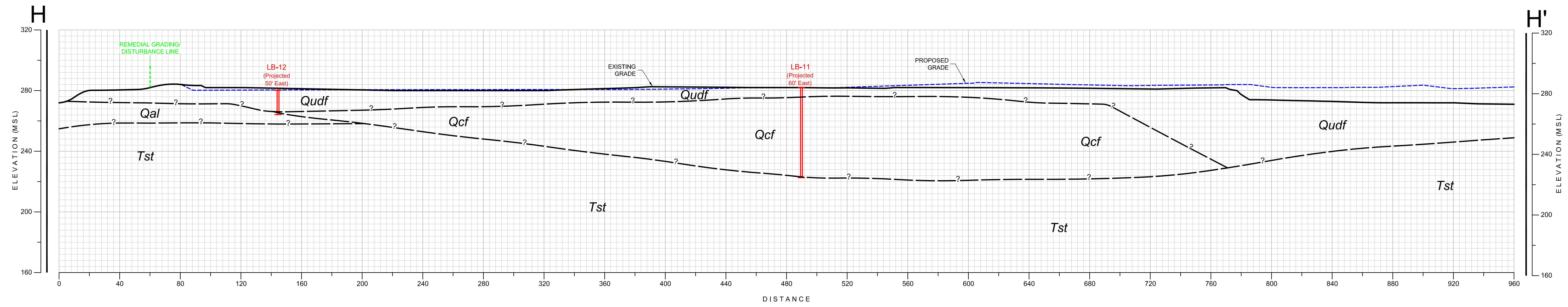

GEOLOGIC CROSS-SECTION H-H'
SCALE: 1" = 40' (Vert. = Horiz.)

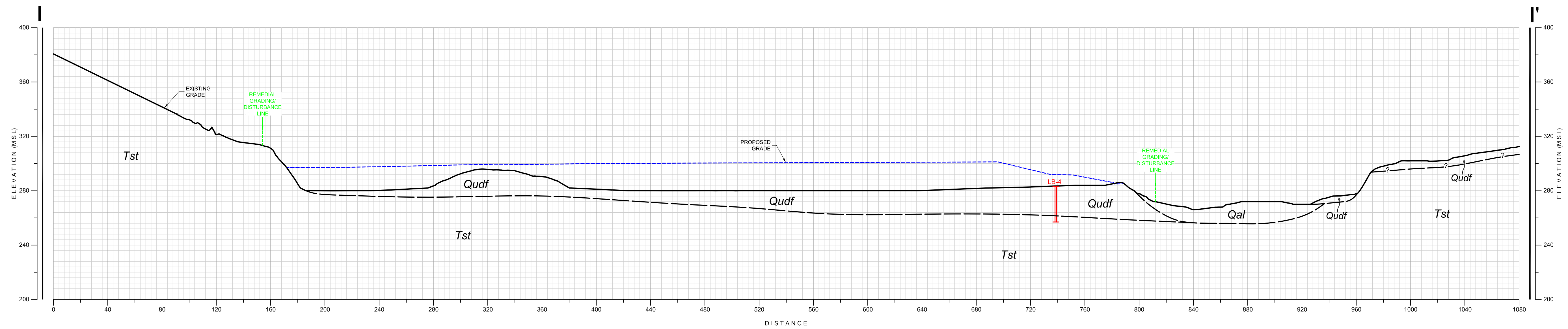

GEOLOGIC CROSS-SECTION I-I'
SCALE: 1" = 40' (Vert. = Horiz.)

- GEOCON LEGEND**
- Qudf* UNDOCUMENTED FILL
 - Qcf* COMPACTED FILL
 - Qal* ALLUVIUM
 - Qc* COLLUVIUM
 - Tst* STADIUM CONGLOMERATE
 - APPROX. LOCATION OF GEOLOGIC CONTACT (Queried Where Uncertain)
 - LB-10 APPROX. LOCATION OF LARGE DIAMETER BORING
 - SB-1 APPROX. LOCATION OF SMALL DIAMETER BORING
 - T-34 APPROX. LOCATION OF EXPLORATORY TRENCH
 - APPROX. LOCATION OF INACTIVE FAULT

GEOLOGIC CROSS SECTION		
3ROOTS SAN DIEGO, CALIFORNIA		
GEOCON INCORPORATED	SCALE 1" = 40'	DATE 11 - 10 - 2017
GEO TECHNICAL ■ ENVIRONMENTAL ■ MATERIALS 6940 ANDROSS DRIVE - SAN DIEGO, CALIFORNIA 92121 - 2974 PHONE 858.558-6900 - FAX 858.558-6159	PROJECT NO. G2070 - 42 - 02	FIGURE 6
SHEET 4 OF 5		

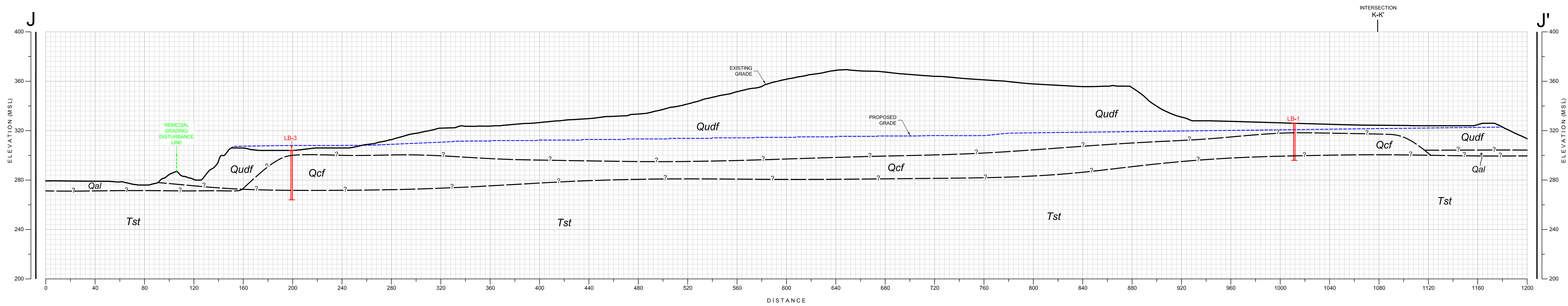

GEOLOGIC CROSS-SECTION J-J'
SCALE: 1" = 40' (Vert. = Horiz.)

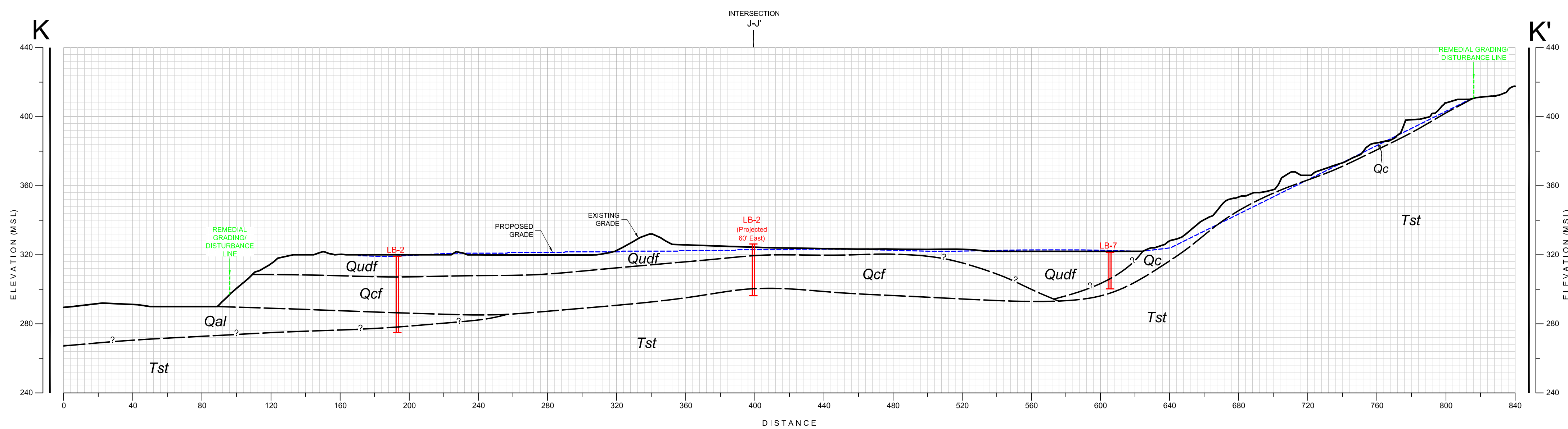

GEOLOGIC CROSS-SECTION K-K'
SCALE: 1" = 40' (Vert. = Horiz.)

- GEOCON LEGEND**
- Qudf UNDOCUMENTED FILL
 - Qcf COMPACTED FILL
 - Qal ALLUVIUM
 - QC COLLUVIUM
 - Tst STADIUM CONGLOMERATE
 - APPROX. LOCATION OF GEOLOGIC CONTACT (Queried Where Uncertain)
 - LB-10 APPROX. LOCATION OF LARGE DIAMETER BORING
 - SB-1 APPROX. LOCATION OF SMALL DIAMETER BORING
 - T-34 APPROX. LOCATION OF EXPLORATORY TRENCH
 - APPROX. LOCATION OF INACTIVE FAULT

GEOLOGIC CROSS SECTION		
3ROOTS SAN DIEGO, CALIFORNIA		
GEOCON INCORPORATED	SCALE 1" = 40'	DATE 11 - 10 - 2017
GEO TECHNICAL ■ ENVIRONMENTAL ■ MATERIALS 6940 SANDERS DRIVE - SAN DIEGO, CALIFORNIA 92121-2974 PHONE 858.558-6900 - FAX 858.558-6159	PROJECT NO. G2070 - 42 - 02	FIGURE 7
SHEET 5 OF 5		

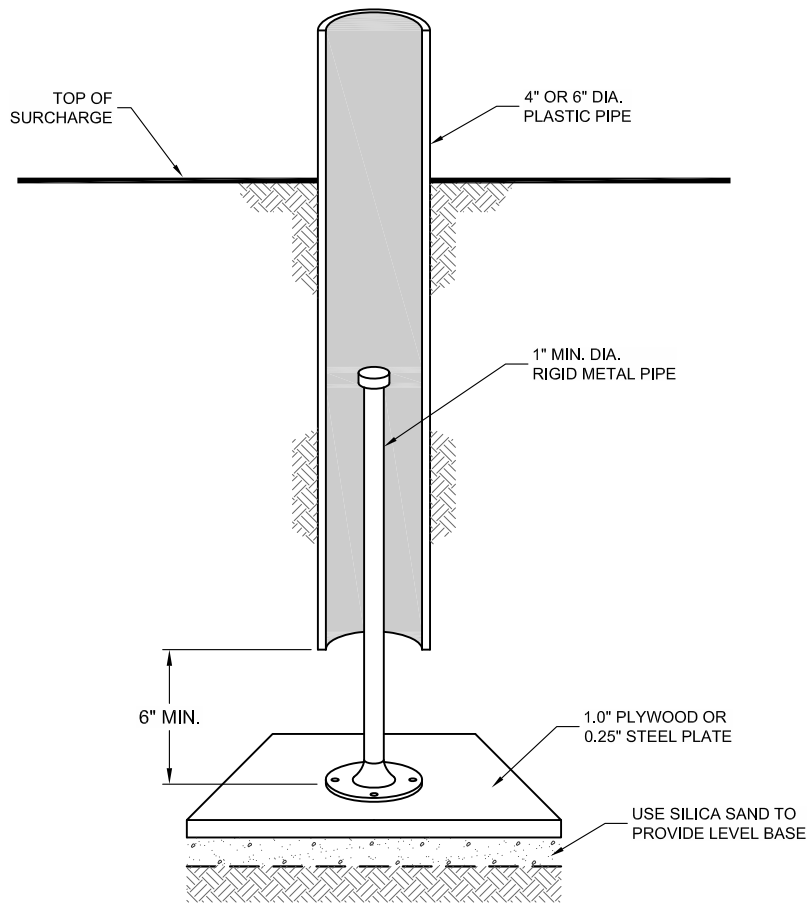

NOTES:

- 1.....LOCATION OF SETTLEMENT PLATES SHALL BE CLEARLY MARKED AND READILY VISIBLE (RED FLAG) TO EQUIPMENT OPERATORS.
- 2.....CONTRACTOR SHALL MAINTAIN 10-FOOT HORIZONTAL CLEARANCE FOR HEAVY EQUIPMENT WITHIN 5 FEET (VERTICAL) OF PLATE BASE. FILL WITHIN CLEARANCE AREA SHALL BE HAND COMPACTED TO PROJECT SPECIFICATIONS OR COMPACTED BY ALTERNATIVE APPROVED SOILS ENGINEER.
- 3.....AFTER 5 FEET (VERTICAL) OF FILL IS IN PLACE, THE CONTRACTOR SHALL MAINTAIN 5 FEET HORIZONTAL EQUIPMENT CLEARANCE. FILL IN CLEARANCE AREA SHALL BE HAND COMPACTED (OR APPROVED ALTERNATIVE) IN VERTICAL INCREMENTS NOT TO EXCEED 2 FEET.
- 4.....IN THE EVENT OF DAMAGE TO SETTLEMENT PLATE OR EXTENSION RESULTING FROM EQUIPMENT OPERATING WITHIN PRESCRIBED CLEARANCE AREA, CONTRACTORS SHALL IMMEDIATELY NOTIFY SOILS ENGINEER AND SHALL BE RESPONSIBLE FOR RESTORING THE SETTLEMENT PLATES TO WORKING ORDER.

NO SCALE

NO SCALE

SETTLEMENT MONUMENT DETAIL

GEOCON
INCORPORATED



GEOTECHNICAL ■ ENVIRONMENTAL ■ MATERIALS
6960 FLANDERS DRIVE - SAN DIEGO, CALIFORNIA 92121 - 2974
PHONE 858 558-6900 - FAX 858 558-6159

3ROOTS
SAN DIEGO, CALIFORNIA

RM / AML

DSK/GTYPD

DATE 11 - 10 - 2017

PROJECT NO. G2070 - 42 - 02

FIG. 8

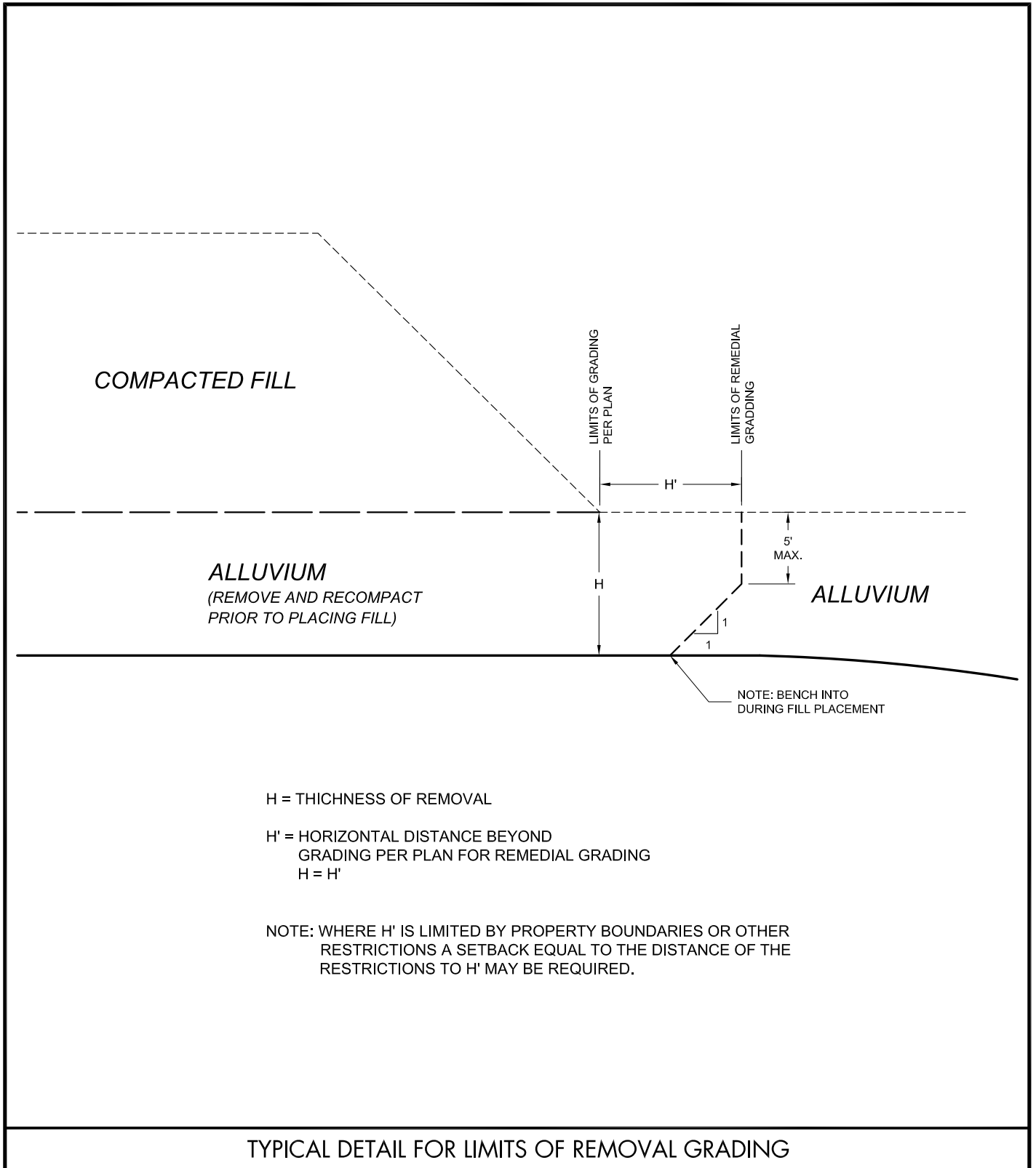

GEOCON
INCORPORATED



GEOTECHNICAL ■ ENVIRONMENTAL ■ MATERIALS
6960 FLANDERS DRIVE - SAN DIEGO, CALIFORNIA 92121 - 2974
PHONE 858 558-6900 - FAX 858 558-6159

RM / AML		DSK/GTYPD
----------	--	-----------

3ROOTS
SAN DIEGO, CALIFORNIA

DATE 11 - 10 - 2017	PROJECT NO. G2070 - 42 - 02	FIG. 9
---------------------	-----------------------------	--------

ASSUMED CONDITIONS :

SLOPE HEIGHT	H = 100 feet
SLOPE INCLINATION	2 : 1 (Horizontal : Vertical)
TOTAL UNIT WEIGHT OF SOIL	$\gamma_t = 135$ pounds per cubic foot
ANGLE OF INTERNAL FRICTION	$\phi = 42$ degrees
APPARENT COHESION	C = 100 pounds per square foot
NO SEEPAGE FORCES	

ANALYSIS :

$\gamma_{c\phi} = \frac{\gamma_t H \tan \phi}{C}$	EQUATION (3-3), REFERENCE 1
FS = $\frac{NcfC}{\gamma_t H}$	EQUATION (3-2), REFERENCE 1
$\gamma_{c\phi} = 122$	CALCULATED USING EQ. (3-3)
Ncf = 250	DETERMINED USING FIGURE 10, REFERENCE 2
FS = 1.85	FACTOR OF SAFETY CALCULATED USING EQ. (3-2)

REFERENCES :

-Janbu, N., Stability Analysis of Slopes with Dimensionless Parameters, Harvard Soil Mechanics, Series No. 46, 1954
-Janbu, N., Discussion of J.M. Bell, Dimensionless Parameters for Homogeneous Earth Slopes, Journal of Soil Mechanics and Foundation Design, No. SM6, November 1967.

SLOPE STABILITY ANALYSIS - CUT SLOPES

GEOCON
INCORPORATED



GEOTECHNICAL ■ ENVIRONMENTAL ■ MATERIALS
6960 FLANDERS DRIVE - SAN DIEGO, CALIFORNIA 92121 - 2974
PHONE 858 558-6900 - FAX 858 558-6159

3ROOTS
SAN DIEGO, CALIFORNIA

RM / AML

DSK/GTYPD

DATE 11 - 10 - 2017

PROJECT NO. G2070 - 42 - 02

FIG. 10

ASSUMED CONDITIONS :

SLOPE HEIGHT	H = 60 feet
SLOPE INCLINATION	2 : 1 (Horizontal : Vertical)
TOTAL UNIT WEIGHT OF SOIL	$\gamma_t = 130$ pounds per cubic foot
ANGLE OF INTERNAL FRICTION	$\phi = 30$ degrees
APPARENT COHESION	C = 300 pounds per square foot
NO SEEPAGE FORCES	

ANALYSIS :

$\gamma_{c\phi} = \frac{\gamma_t H \tan \phi}{C}$	EQUATION (3-3), REFERENCE 1
FS = $\frac{NcfC}{\gamma_t H}$	EQUATION (3-2), REFERENCE 1
$\gamma_{c\phi} = 15$	CALCULATED USING EQ. (3-3)
Ncf = 43	DETERMINED USING FIGURE 10, REFERENCE 2
FS = 1.65	FACTOR OF SAFETY CALCULATED USING EQ. (3-2)

REFERENCES :

- 1.....Janbu, N., Stability Analysis of Slopes with Dimensionless Parameters, Harvard Soil Mechanics, Series No. 46, 1954
- 2.....Janbu, N., Discussion of J.M. Bell, Dimensionless Parameters for Homogeneous Earth Slopes, Journal of Soil Mechanics and Foundation Design, No. SM6, November 1967.

SLOPE STABILITY ANALYSIS - FILL SLOPES

GEOCON
INCORPORATED



GEOTECHNICAL ■ ENVIRONMENTAL ■ MATERIALS
6960 FLANDERS DRIVE - SAN DIEGO, CALIFORNIA 92121 - 2974
PHONE 858 558-6900 - FAX 858 558-6159

3ROOTS
SAN DIEGO, CALIFORNIA

RM / AML

DSK/GTYPD

DATE 11 - 10 - 2017

PROJECT NO. G2070 - 42 - 02

FIG. 11

ASSUMED CONDITIONS :

SLOPE HEIGHT	H = Infinite
DEPTH OF SATURATION	Z = 3 feet
SLOPE INCLINATION	2 : 1 (Horizontal : Vertical)
SLOPE ANGLE	i = 26.6 degrees
UNIT WEIGHT OF WATER	γ_w = 62.4 pounds per cubic foot
TOTAL UNIT WEIGHT OF SOIL	γ_t = 130 pounds per cubic foot
ANGLE OF INTERNAL FRICTION	ϕ = 30 degrees
APPARENT COHESION	C = 300 pounds per square foot

SLOPE SATURATED TO VERTICAL DEPTH Z BELOW SLOPE FACE

SEEPAGE FORCES PARALLEL TO SLOPE FACE

ANALYSIS :

$$FS = \frac{C + (\gamma_t - \gamma_w) Z \cos^2 i \tan \phi}{\gamma_t Z \sin i \cos i} = 2.5$$

REFERENCES :

- 1.....Haefeli, R. *The Stability of Slopes Acted Upon by Parallel Seepage*, Proc. Second International Conference, SMFE, Rotterdam, 1948, 1, 57-62
- 2.....Skempton, A. W., and F.A. Delory, *Stability of Natural Slopes in London Clay*, Proc. Fourth International Conference, SMFE, London, 1957, 2, 378-81

SURFICIAL SLOPE STABILITY ANALYSIS

GEOCON
INCORPORATED



GEOTECHNICAL ■ ENVIRONMENTAL ■ MATERIALS
6960 FLANDERS DRIVE - SAN DIEGO, CALIFORNIA 92121 - 2974
PHONE 858 558-6900 - FAX 858 558-6159

3ROOTS
SAN DIEGO, CALIFORNIA

RM / AML

DSK/GTYPD

DATE 11 - 10 - 2017

PROJECT NO. G2070 - 42 - 02

FIG. 12

APPENDIX

A

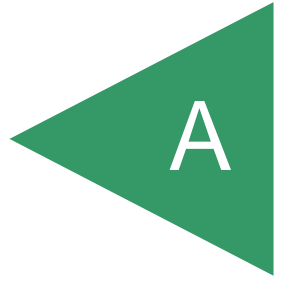

APPENDIX A

FIELD INVESTIGATION

Fieldwork for our investigations included subsurface exploration and soil sampling. The approximate locations of the exploratory borings and trenches are shown on the *Geologic Map*, Figure 2. We located the borings and trenches in the field based using existing site reference points. Therefore, actual boring and trench locations may deviate slightly.

The previous and recent field investigations were performed between June 13 and November 3, 2107. The exploration collectively consisted of excavating 69 exploratory trenches, drilling and downhole logging of 17 large-diameter bucket auger borings, and drilling 8 small-diameter borings. The small diameter borings were drilled to depths up to 115 feet below the ground surface using a CME 95 drill rig with 8-inch, hollow-stem augers. The large-diameter borings were advanced using an EZ Bore bucket auger drill rig equipped with a 30-inch-diameter bucket. The trenches were excavated using either a John Deere 410 rubber-tire backhoe, a Caterpillar 330 excavator or a John Deere 350 excavator using either a 24 to 48-inch wide bucket.

We obtained relatively undisturbed soil samples from the borings using a California Modified split-spoon sampler. The sampler has an inside diameter of 2.5 inches and an outside diameter of 2.875 inches. Up to 18 rings that are 2.4 inches in diameter and 1.0 inch in height are placed inside the sampler. Soil samples were collected by driving the sampler 12-inches into the bottom of the excavation using a 140-pound hammer on the small-diameter drill rig or a 1,300 to 3,500-pound Kelly bar on the large-diameter drill rig. The number of blows required to drive the sampler 12 inches was recorded. The penetration resistances shown on the boring logs are shown in terms of blows per foot. These values are not to be taken as N-values. Ring samples were retained in moisture-tight containers and transported to our laboratory for testing. Bulk samples were also collected from the borings and trenches for laboratory testing. The type of sample is noted on the exploratory boring and trench logs.

We visually examined, classified and logged the soil conditions encountered in the borings in general accordance with American Society for Testing and Materials (ASTM) practice for Description and Identification of Soils (Visual-Manual Procedure D 2488). Logs of the exploratory borings and trenches are presented on Figures A-1 through A-94. The logs depict the soil and geologic conditions encountered and the depth at which samples were obtained. Elevations shown on the logs were based on existing elevations shown on plans provided for our use.







DEPTH IN FEET	SAMPLE NO.	LITHOLOGY	GROUNDWATER	SOIL CLASS (USCS)	TRENCH T 1		PENETRATION RESISTANCE (BLOWS/FT.)	DRY DENSITY (P.C.F.)	MOISTURE CONTENT (%)
					ELEV. (MSL.) <u>257'</u>	DATE COMPLETED <u>06-13-2017</u>			
					EQUIPMENT <u>RUBBER TIRE BACKHOE</u>		BY: <u>R. ADAMS</u>		
MATERIAL DESCRIPTION									
0				SM	UNDOCUMENTED FILL (Qudf) Loose to medium dense, dry to damp, light brown to yellowish brown, Silty, fine to medium SAND; trace cobble				
2				SC	Loose to medium dense, damp to moist, brown to dark brown, Clayey SAND with 15-20% cobble up to 8-inches				
4									
6									
TRENCH TERMINATED AT 7 FEET									

Figure A-1,
Log of Trench T 1, Page 1 of 1

G2070-42-02.GPJ

SAMPLE SYMBOLS		... SAMPLING UNSUCCESSFUL		... STANDARD PENETRATION TEST		... DRIVE SAMPLE (UNDISTURBED)
		... DISTURBED OR BAG SAMPLE		... CHUNK SAMPLE		... WATER TABLE OR SEEPAGE

NOTE: THE LOG OF SUBSURFACE CONDITIONS SHOWN HEREON APPLIES ONLY AT THE SPECIFIC BORING OR TRENCH LOCATION AND AT THE DATE INDICATED. IT IS NOT WARRANTED TO BE REPRESENTATIVE OF SUBSURFACE CONDITIONS AT OTHER LOCATIONS AND TIMES.

DEPTH IN FEET	SAMPLE NO.	LITHOLOGY	GROUNDWATER	SOIL CLASS (USCS)	TRENCH T 2		PENETRATION RESISTANCE (BLOWS/FT.)	DRY DENSITY (P.C.F.)	MOISTURE CONTENT (%)
					ELEV. (MSL.) <u>254'</u>	DATE COMPLETED <u>06-13-2017</u>			
					EQUIPMENT <u>RUBBER TIRE BACKHOE</u> BY: <u>R. ADAMS</u>				
MATERIAL DESCRIPTION									
0	T2-1			SM	<p>UNDOCUMENTED FILL (Qudf) Loose, dry, pale yellowish brown, Silty, fine to medium SAND; trace cobble, few small rootlets</p> <p>Loose to medium dense, damp to moist, brown to dark brown, Clayey SAND with ±20% cobble up to 10-inches, and some organic debris</p>				
2				SC					
4									
6									
8					TRENCH TERMINATED AT 8 FEET				

Figure A-2,
Log of Trench T 2, Page 1 of 1

G2070-42-02.GPJ

SAMPLE SYMBOLS		... SAMPLING UNSUCCESSFUL		... STANDARD PENETRATION TEST		... DRIVE SAMPLE (UNDISTURBED)
		... DISTURBED OR BAG SAMPLE		... CHUNK SAMPLE		... WATER TABLE OR SEEPAGE

NOTE: THE LOG OF SUBSURFACE CONDITIONS SHOWN HEREON APPLIES ONLY AT THE SPECIFIC BORING OR TRENCH LOCATION AND AT THE DATE INDICATED. IT IS NOT WARRANTED TO BE REPRESENTATIVE OF SUBSURFACE CONDITIONS AT OTHER LOCATIONS AND TIMES.

DEPTH IN FEET	SAMPLE NO.	LITHOLOGY	GROUNDWATER	SOIL CLASS (USCS)	TRENCH T 3		PENETRATION RESISTANCE (BLOWS/FT.)	DRY DENSITY (P.C.F.)	MOISTURE CONTENT (%)			
					ELEV. (MSL.) <u>252'</u>	DATE COMPLETED <u>06-13-2017</u>						
					EQUIPMENT <u>RUBBER TIRE BACKHOE</u>		BY: <u>R. ADAMS</u>					
MATERIAL DESCRIPTION												
0	T3-1			SM	UNDOCUMENTED FILL (Qudf) Loose, damp, pale yellowish brown to orange brown, Silty, fine to coarse SAND with abundant gravel and cobble up to 10-inches in diameter; trace organic debris and minor caving							
2												
4												
6												
8												
TRENCH TERMINATED AT 9 FEET												

Figure A-3,
Log of Trench T 3, Page 1 of 1

G2070-42-02.GPJ

SAMPLE SYMBOLS	... SAMPLING UNSUCCESSFUL	... STANDARD PENETRATION TEST	... DRIVE SAMPLE (UNDISTURBED)
	... DISTURBED OR BAG SAMPLE	... CHUNK SAMPLE	... WATER TABLE OR SEEPAGE

NOTE: THE LOG OF SUBSURFACE CONDITIONS SHOWN HEREON APPLIES ONLY AT THE SPECIFIC BORING OR TRENCH LOCATION AND AT THE DATE INDICATED. IT IS NOT WARRANTED TO BE REPRESENTATIVE OF SUBSURFACE CONDITIONS AT OTHER LOCATIONS AND TIMES.

DEPTH IN FEET	SAMPLE NO.	LITHOLOGY	GROUNDWATER	SOIL CLASS (USCS)	TRENCH T 4		PENETRATION RESISTANCE (BLOWS/FT.)	DRY DENSITY (P.C.F.)	MOISTURE CONTENT (%)
					ELEV. (MSL.) <u>251'</u>	DATE COMPLETED <u>06-13-2017</u>			
					EQUIPMENT <u>RUBBER TIRE BACKHOE</u>		BY: <u>R. ADAMS</u>		
MATERIAL DESCRIPTION									
0				SM	UNDOCUMENTED FILL (Qudf) Loose, dry and damp, pale yellowish brown, Silty, fine to medium SAND with 15-20% cobble up to 8-inch in diameter; rootlets throughout				
2									
4					SM	Loose to medium dense, damp to moist, brown to dark brown, Silty, fine to medium SAND with clay; 5-10% cobble up to 6-inch in diameter			
6									
8				CL&SC	Stiff/loose to medium dense, moist, very dark brown and black, fine, Sandy CLAY and Clayey SAND; trace cobble				
					TRENCH TERMINATED AT 9 FEET				

Figure A-4,
Log of Trench T 4, Page 1 of 1

G2070-42-02.GPJ

SAMPLE SYMBOLS		... SAMPLING UNSUCCESSFUL		... STANDARD PENETRATION TEST		... DRIVE SAMPLE (UNDISTURBED)
		... DISTURBED OR BAG SAMPLE		... CHUNK SAMPLE		... WATER TABLE OR SEEPAGE

NOTE: THE LOG OF SUBSURFACE CONDITIONS SHOWN HEREON APPLIES ONLY AT THE SPECIFIC BORING OR TRENCH LOCATION AND AT THE DATE INDICATED. IT IS NOT WARRANTED TO BE REPRESENTATIVE OF SUBSURFACE CONDITIONS AT OTHER LOCATIONS AND TIMES.







DEPTH IN FEET	SAMPLE NO.	LITHOLOGY	GROUNDWATER	SOIL CLASS (USCS)	TRENCH T 5		PENETRATION RESISTANCE (BLOWS/FT.)	DRY DENSITY (P.C.F.)	MOISTURE CONTENT (%)
					ELEV. (MSL.) <u>253'</u>	DATE COMPLETED <u>06-13-2017</u>			
					EQUIPMENT <u>RUBBER TIRE BACKHOE</u>		BY: <u>R. ADAMS</u>		
MATERIAL DESCRIPTION									
0	T5-1			SC	UNDOCUMENTED FILL (Qudf) Loose, dry to damp, brown to yellowish brown, Clayey SAND with silt and <10% cobble up to 8-inches in diameter				
2				CL	Stiff, moist, dark brown, fine, Sandy CLAY with cobble up to 8-inches in diameter				
4									
6	TRENCH TERMINATED AT 9 FEET								
8									

Figure A-5,
Log of Trench T 5, Page 1 of 1

G2070-42-02.GPJ

SAMPLE SYMBOLS	 ... SAMPLING UNSUCCESSFUL	 ... STANDARD PENETRATION TEST	 ... DRIVE SAMPLE (UNDISTURBED)
	 ... DISTURBED OR BAG SAMPLE	 ... CHUNK SAMPLE	 ... WATER TABLE OR SEEPAGE

NOTE: THE LOG OF SUBSURFACE CONDITIONS SHOWN HEREON APPLIES ONLY AT THE SPECIFIC BORING OR TRENCH LOCATION AND AT THE DATE INDICATED. IT IS NOT WARRANTED TO BE REPRESENTATIVE OF SUBSURFACE CONDITIONS AT OTHER LOCATIONS AND TIMES.

DEPTH IN FEET	SAMPLE NO.	LITHOLOGY	GROUNDWATER	SOIL CLASS (USCS)	TRENCH T 6		PENETRATION RESISTANCE (BLOWS/FT.)	DRY DENSITY (P.C.F.)	MOISTURE CONTENT (%)
					ELEV. (MSL.) <u>254'</u>	DATE COMPLETED <u>06-13-2017</u>			
					EQUIPMENT <u>RUBBER TIRE BACKHOE</u>		BY: <u>R. ADAMS</u>		
MATERIAL DESCRIPTION									
0				SM	UNDOCUMENTED FILL (Qudf) Loose to very loose, dry, pale brown, Silty, fine to medium SAND with 20% cobble up to 10-inches in diameter; abundant rootlets				
2									
4					SM	Medium dense, damp, brown, Silty, fine to medium SAND; 10-15% cobble up to 6-inches in diameter			
6									
8				CL	Stiff, damp to moist, dark brown, Sandy CLAY; trace cobble up to 6-inches				
TRENCH TERMINATED AT 8.5 FEET									

Figure A-6,
Log of Trench T 6, Page 1 of 1

G2070-42-02.GPJ

SAMPLE SYMBOLS	... SAMPLING UNSUCCESSFUL	... STANDARD PENETRATION TEST	... DRIVE SAMPLE (UNDISTURBED)
	... DISTURBED OR BAG SAMPLE	... CHUNK SAMPLE	... WATER TABLE OR SEEPAGE

NOTE: THE LOG OF SUBSURFACE CONDITIONS SHOWN HEREON APPLIES ONLY AT THE SPECIFIC BORING OR TRENCH LOCATION AND AT THE DATE INDICATED. IT IS NOT WARRANTED TO BE REPRESENTATIVE OF SUBSURFACE CONDITIONS AT OTHER LOCATIONS AND TIMES.

DEPTH IN FEET	SAMPLE NO.	LITHOLOGY	GROUNDWATER	SOIL CLASS (USCS)	TRENCH T 7		PENETRATION RESISTANCE (BLOWS/FT.)	DRY DENSITY (P.C.F.)	MOISTURE CONTENT (%)
					ELEV. (MSL.) <u>252'</u>	DATE COMPLETED <u>06-13-2017</u>			
					EQUIPMENT <u>RUBBER TIRE BACKHOE</u>		BY: <u>R. ADAMS</u>		
MATERIAL DESCRIPTION									
0				SM	UNDOCUMENTED FILL (Qudf) Loose, dry, light brown, Silty, fine SAND; 2-5% gravel up to 2-inches; abundant rootlets				
2				SP	Loose to medium dense, damp, orange brown to reddish brown, fine to medium SAND with 10-20% cobble up to 12-inches in diameter				
4					-Cobble content increases to 20-30% below 8 feet				
6									
8									
10									
12				SW	STADIUM CONGLOMERATE (Tst) Dense to very dense, damp, yellowish/orangish to orange brown, fine to medium SAND with cobble up to 10-inches; difficult trenching due to caving				
14					TRENCH TERMINATED AT 14 FEET				

Figure A-7,
Log of Trench T 7, Page 1 of 1

G2070-42-02.GPJ

SAMPLE SYMBOLS	... SAMPLING UNSUCCESSFUL	... STANDARD PENETRATION TEST	... DRIVE SAMPLE (UNDISTURBED)
	... DISTURBED OR BAG SAMPLE	... CHUNK SAMPLE	... WATER TABLE OR SEEPAGE

NOTE: THE LOG OF SUBSURFACE CONDITIONS SHOWN HEREON APPLIES ONLY AT THE SPECIFIC BORING OR TRENCH LOCATION AND AT THE DATE INDICATED. IT IS NOT WARRANTED TO BE REPRESENTATIVE OF SUBSURFACE CONDITIONS AT OTHER LOCATIONS AND TIMES.

DEPTH IN FEET	SAMPLE NO.	LITHOLOGY	GROUNDWATER	SOIL CLASS (USCS)	TRENCH T 8		PENETRATION RESISTANCE (BLOWS/FT.)	DRY DENSITY (P.C.F.)	MOISTURE CONTENT (%)	
					ELEV. (MSL.) <u>246'</u>	DATE COMPLETED <u>06-13-2017</u>				
					EQUIPMENT <u>RUBBER TIRE BACKHOE</u>		BY: <u>R. ADAMS</u>			
MATERIAL DESCRIPTION										
0				SM	UNDOCUMENTED FILL (Qudf) Loose, dry to damp, light brown to grayish brown, Silty, fine to medium SAND with abundant cobble and boulders up to 38-inches; concrete debris also present -Becomes moist to wet below 9 feet -Heavy seepage at 11 feet					
2										
4										
6										
8										
10										
12					SW	STADIUM CONGLOMERATE (Tst) Dense, wet, orange brown to yellow/brown, medium SAND with cobble up to 10-inches TRENCH TERMINATED AT 13 FEET				

Figure A-8,
Log of Trench T 8, Page 1 of 1

G2070-42-02.GPJ

SAMPLE SYMBOLS	... SAMPLING UNSUCCESSFUL	... STANDARD PENETRATION TEST	... DRIVE SAMPLE (UNDISTURBED)
	... DISTURBED OR BAG SAMPLE	... CHUNK SAMPLE	... WATER TABLE OR SEEPAGE

NOTE: THE LOG OF SUBSURFACE CONDITIONS SHOWN HEREON APPLIES ONLY AT THE SPECIFIC BORING OR TRENCH LOCATION AND AT THE DATE INDICATED. IT IS NOT WARRANTED TO BE REPRESENTATIVE OF SUBSURFACE CONDITIONS AT OTHER LOCATIONS AND TIMES.

DEPTH IN FEET	SAMPLE NO.	LITHOLOGY	GROUNDWATER	SOIL CLASS (USCS)	TRENCH T 9		PENETRATION RESISTANCE (BLOWS/FT.)	DRY DENSITY (P.C.F.)	MOISTURE CONTENT (%)	
					ELEV. (MSL.) <u>321'</u>	DATE COMPLETED <u>06-13-2017</u>				
					EQUIPMENT <u>RUBBER TIRE BACKHOE</u>		BY: <u>R. ADAMS</u>			
MATERIAL DESCRIPTION										
0	T9-1			SM	UNDOCUMENTED FILL (Qudf) Loose to medium dense, dry, pale yellowish brown, Silty, fine to medium SAND with <10% cobble up to 8-inches					
2										
4										
6	T9-2			SC	COLLUVIUM (Qc) Loose, moist to wet, black to dark brown, Clayey, fine to coarse SAND with cobble; caving on both sides					
8										
10										
12										
14										
TRENCH TERMINATED AT 14 FEET										

Figure A-9,
Log of Trench T 9, Page 1 of 1

G2070-42-02.GPJ







SAMPLE SYMBOLS		... SAMPLING UNSUCCESSFUL		... STANDARD PENETRATION TEST		... DRIVE SAMPLE (UNDISTURBED)
		... DISTURBED OR BAG SAMPLE		... CHUNK SAMPLE		... WATER TABLE OR SEEPAGE

NOTE: THE LOG OF SUBSURFACE CONDITIONS SHOWN HEREON APPLIES ONLY AT THE SPECIFIC BORING OR TRENCH LOCATION AND AT THE DATE INDICATED. IT IS NOT WARRANTED TO BE REPRESENTATIVE OF SUBSURFACE CONDITIONS AT OTHER LOCATIONS AND TIMES.

DEPTH IN FEET	SAMPLE NO.	LITHOLOGY	GROUNDWATER	SOIL CLASS (USCS)	TRENCH T 10		PENETRATION RESISTANCE (BLOWS/FT.)	DRY DENSITY (P.C.F.)	MOISTURE CONTENT (%)
					ELEV. (MSL.) <u>323'</u>	DATE COMPLETED <u>06-13-2017</u>			
					EQUIPMENT <u>RUBBER TIRE BACKHOE</u>		BY: <u>R. ADAMS</u>		
MATERIAL DESCRIPTION									
0				ML	UNDOCUMENTED FILL (Qudf) Loose, dry, pale grayish brown, Sandy SILT; trace gravel				
2				SC	Medium dense, damp, yellowish brown, Clayey SAND with cobble and some rootlets				
4									
6				SW/SP	COLLUVIUM (Qc) Loose, moist, black to dark brown, medium to coarse SAND with ±10% gravel and cobble up to 8-inches in diameter; some caving				
8									
10									
12									
14					-Becomes wet with moderate seepage at 14 feet				
16									
TRENCH TERMINATED AT 17 FEET									

Figure A-10,
Log of Trench T 10, Page 1 of 1

G2070-42-02.GPJ

SAMPLE SYMBOLS	 ... SAMPLING UNSUCCESSFUL	 ... STANDARD PENETRATION TEST	 ... DRIVE SAMPLE (UNDISTURBED)
	 ... DISTURBED OR BAG SAMPLE	 ... CHUNK SAMPLE	 ... WATER TABLE OR SEEPAGE

NOTE: THE LOG OF SUBSURFACE CONDITIONS SHOWN HEREON APPLIES ONLY AT THE SPECIFIC BORING OR TRENCH LOCATION AND AT THE DATE INDICATED. IT IS NOT WARRANTED TO BE REPRESENTATIVE OF SUBSURFACE CONDITIONS AT OTHER LOCATIONS AND TIMES.







DEPTH IN FEET	SAMPLE NO.	LITHOLOGY	GROUNDWATER	SOIL CLASS (USCS)	TRENCH T 11		PENETRATION RESISTANCE (BLOWS/FT.)	DRY DENSITY (P.C.F.)	MOISTURE CONTENT (%)
					ELEV. (MSL.) <u>325'</u>	DATE COMPLETED <u>06-13-2017</u>			
					EQUIPMENT <u>RUBBER TIRE BACKHOE</u>		BY: <u>R. ADAMS</u>		
MATERIAL DESCRIPTION									
0	T-11			SM	UNDOCUMENTED FILL (Qudf) Loose, dry, pale brown, Silty SAND with gravel				
2				SM	COMPACTED FILL (Qcf) Medium dense, damp to moist, pale yellowish brown, Silty, fine SAND; trace cobble				
4				SM	Medium dense, damp to moist, yellowish brown to orange brown, Silty, fine to medium SAND with ±10-15% cobble up to 8-inches in diameter				
6					-Concrete chunks at 7 feet				
8									
10									
12									
14									
TRENCH TERMINATED AT 15 FEET									

Figure A-11,
Log of Trench T 11, Page 1 of 1

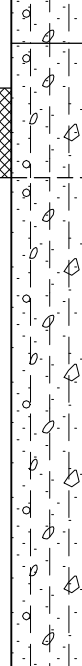
G2070-42-02.GPJ

SAMPLE SYMBOLS		... SAMPLING UNSUCCESSFUL		... STANDARD PENETRATION TEST		... DRIVE SAMPLE (UNDISTURBED)
		... DISTURBED OR BAG SAMPLE		... CHUNK SAMPLE		... WATER TABLE OR SEEPAGE

NOTE: THE LOG OF SUBSURFACE CONDITIONS SHOWN HEREON APPLIES ONLY AT THE SPECIFIC BORING OR TRENCH LOCATION AND AT THE DATE INDICATED. IT IS NOT WARRANTED TO BE REPRESENTATIVE OF SUBSURFACE CONDITIONS AT OTHER LOCATIONS AND TIMES.

DEPTH IN FEET	SAMPLE NO.	LITHOLOGY	GROUNDWATER	SOIL CLASS (USCS)	TRENCH T 12		PENETRATION RESISTANCE (BLOWS/FT.)	DRY DENSITY (P.C.F.)	MOISTURE CONTENT (%)
					ELEV. (MSL.) <u>320'</u>	DATE COMPLETED <u>06-13-2017</u>			
					EQUIPMENT <u>RUBBER TIRE BACKHOE</u>		BY: <u>R. ADAMS</u>		
MATERIAL DESCRIPTION									
0				SM	UNDOCUMENTED FILL (Qudf) Loose to medium dense, dry to damp, Silty, fine SAND with some cobble; several 24-36-inch boulders encountered; abundant roots				
2									
4					SM	Medium dense, damp, brown to pale yellowish brown, Silty, fine to medium SAND with ±10% cobble up to 8-inches			
6									
8									
10									
12						-Becomes moist at 11 feet			
14				SC	Medium dense, moist to wet, yellowish brown to orange brown, Clayey fine to medium SAND with ±15-20% cobble up to 10-inch in diameter				
16					TRENCH TERMINATED AT 16 FEET				

Figure A-12,
Log of Trench T 12, Page 1 of 1

G2070-42-02.GPJ

SAMPLE SYMBOLS	... SAMPLING UNSUCCESSFUL	... STANDARD PENETRATION TEST	... DRIVE SAMPLE (UNDISTURBED)
	... DISTURBED OR BAG SAMPLE	... CHUNK SAMPLE	... WATER TABLE OR SEEPAGE

NOTE: THE LOG OF SUBSURFACE CONDITIONS SHOWN HEREON APPLIES ONLY AT THE SPECIFIC BORING OR TRENCH LOCATION AND AT THE DATE INDICATED. IT IS NOT WARRANTED TO BE REPRESENTATIVE OF SUBSURFACE CONDITIONS AT OTHER LOCATIONS AND TIMES.

DEPTH IN FEET	SAMPLE NO.	LITHOLOGY	GROUNDWATER	SOIL CLASS (USCS)	TRENCH T 13		PENETRATION RESISTANCE (BLOWS/FT.)	DRY DENSITY (P.C.F.)	MOISTURE CONTENT (%)
					ELEV. (MSL.) <u>316'</u>	DATE COMPLETED <u>06-13-2017</u>			
					EQUIPMENT <u>RUBBER TIRE BACKHOE</u> BY: <u>R. ADAMS</u>				
					MATERIAL DESCRIPTION				
0				SM	UNDOCUMENTED FILL (Qudf) Loose to medium dense, dry, Silty, fine SAND; trace gravel up to 1-inch in diameter; shallow rootlets				
2									
4				SC	COMPACTED FILL (Qcf) Medium dense to dense, damp to moist, yellowish brown to orange brown, Clayey, fine to coarse SAND with <10% gravel and cobble up to 4-inches				
6	T13-1								
8									
10									
12									
14					TRENCH TERMINATED AT 14 FEET				

Figure A-13,
Log of Trench T 13, Page 1 of 1

G2070-42-02.GPJ

SAMPLE SYMBOLS		... SAMPLING UNSUCCESSFUL		... STANDARD PENETRATION TEST		... DRIVE SAMPLE (UNDISTURBED)
		... DISTURBED OR BAG SAMPLE		... CHUNK SAMPLE		... WATER TABLE OR SEEPAGE

NOTE: THE LOG OF SUBSURFACE CONDITIONS SHOWN HEREON APPLIES ONLY AT THE SPECIFIC BORING OR TRENCH LOCATION AND AT THE DATE INDICATED. IT IS NOT WARRANTED TO BE REPRESENTATIVE OF SUBSURFACE CONDITIONS AT OTHER LOCATIONS AND TIMES.

DEPTH IN FEET	SAMPLE NO.	LITHOLOGY	GROUNDWATER	SOIL CLASS (USCS)	TRENCH T 14		PENETRATION RESISTANCE (BLOWS/FT.)	DRY DENSITY (P.C.F.)	MOISTURE CONTENT (%)
					ELEV. (MSL.) <u>306'</u>	DATE COMPLETED <u>06-13-2017</u>			
					EQUIPMENT <u>RUBBER TIRE BACKHOE</u>		BY: <u>R. ADAMS</u>		
MATERIAL DESCRIPTION									
0				SM	UNDOCUMENTED FILL (Qudf) Loose to medium dense, dry, pale grayish brown to brown, Silty, fine SAND; trace gravel				
2									
4				SC	COMPACTED FILL (Qcf) Medium dense to dense, damp to moist, orange brown, Clayey, fine to medium SAND with ±10% cobble up to 6-inches in diameter but mostly <1-inch in diameter				
6									
8									
10									
12					TRENCH TERMINATED AT 12 FEET				

Figure A-14,
Log of Trench T 14, Page 1 of 1

G2070-42-02.GPJ

SAMPLE SYMBOLS		... SAMPLING UNSUCCESSFUL		... STANDARD PENETRATION TEST		... DRIVE SAMPLE (UNDISTURBED)
		... DISTURBED OR BAG SAMPLE		... CHUNK SAMPLE		... WATER TABLE OR SEEPAGE

NOTE: THE LOG OF SUBSURFACE CONDITIONS SHOWN HEREON APPLIES ONLY AT THE SPECIFIC BORING OR TRENCH LOCATION AND AT THE DATE INDICATED. IT IS NOT WARRANTED TO BE REPRESENTATIVE OF SUBSURFACE CONDITIONS AT OTHER LOCATIONS AND TIMES.

DEPTH IN FEET	SAMPLE NO.	LITHOLOGY	GROUNDWATER	SOIL CLASS (USCS)	TRENCH T 15		PENETRATION RESISTANCE (BLOWS/FT.)	DRY DENSITY (P.C.F.)	MOISTURE CONTENT (%)
					ELEV. (MSL.) <u>375'</u>	DATE COMPLETED <u>06-13-2017</u>			
					EQUIPMENT <u>RUBBER TIRE BACKHOE</u>		BY: <u>R. ADAMS</u>		
MATERIAL DESCRIPTION									
0				SM	COLLUVIUM (Qc) Loose, dry, pale brown, Silty, fine SAND; some gravel and cobble				
2				SC	Medium dense, damp to moist, brown to dark brown and grayish brown, Clayey SAND with cobble up to 10-inches in diameter				
4				SW	STADIUM CONGLOMERATE (Tst) Very dense, damp, mottled grayish brown to orange brown, medium to coarse SANDSTONE with cobble up to 8-inches; moderately cemented				
6					TRENCH TERMINATED AT 8 FEET				
8									

Figure A-15,
Log of Trench T 15, Page 1 of 1

G2070-42-02.GPJ

SAMPLE SYMBOLS	... SAMPLING UNSUCCESSFUL	... STANDARD PENETRATION TEST	... DRIVE SAMPLE (UNDISTURBED)
	... DISTURBED OR BAG SAMPLE	... CHUNK SAMPLE	... WATER TABLE OR SEEPAGE

NOTE: THE LOG OF SUBSURFACE CONDITIONS SHOWN HEREON APPLIES ONLY AT THE SPECIFIC BORING OR TRENCH LOCATION AND AT THE DATE INDICATED. IT IS NOT WARRANTED TO BE REPRESENTATIVE OF SUBSURFACE CONDITIONS AT OTHER LOCATIONS AND TIMES.







DEPTH IN FEET	SAMPLE NO.	LITHOLOGY	GROUNDWATER	SOIL CLASS (USCS)	TRENCH T 16			PENETRATION RESISTANCE (BLOWS/FT.)	DRY DENSITY (P.C.F.)	MOISTURE CONTENT (%)
					ELEV. (MSL.) <u>384'</u>	DATE COMPLETED <u>06-13-2017</u>	EQUIPMENT <u>RUBBER TIRE BACKHOE</u> BY: <u>R. ADAMS</u>			
MATERIAL DESCRIPTION										
0	T16-1			SC	UNDOCUMENTED FILL (Qudf) Medium dense, dry to damp, yellowish brown, Clayey, medium SAND; trace cobble up to 2-inches in diameter					
2										
4										
6										
TRENCH TERMINATED AT 7 FEET										

Figure A-16,
Log of Trench T 16, Page 1 of 1

G2070-42-02.GPJ







SAMPLE SYMBOLS	 ... SAMPLING UNSUCCESSFUL	 ... STANDARD PENETRATION TEST	 ... DRIVE SAMPLE (UNDISTURBED)
	 ... DISTURBED OR BAG SAMPLE	 ... CHUNK SAMPLE	 ... WATER TABLE OR SEEPAGE

NOTE: THE LOG OF SUBSURFACE CONDITIONS SHOWN HEREON APPLIES ONLY AT THE SPECIFIC BORING OR TRENCH LOCATION AND AT THE DATE INDICATED. IT IS NOT WARRANTED TO BE REPRESENTATIVE OF SUBSURFACE CONDITIONS AT OTHER LOCATIONS AND TIMES.

DEPTH IN FEET	SAMPLE NO.	LITHOLOGY	GROUNDWATER	SOIL CLASS (USCS)	TRENCH T 17		PENETRATION RESISTANCE (BLOWS/FT.)	DRY DENSITY (P.C.F.)	MOISTURE CONTENT (%)
					ELEV. (MSL.) <u>386'</u>	DATE COMPLETED <u>06-13-2017</u>			
					EQUIPMENT <u>RUBBER TIRE BACKHOE</u> BY: <u>R. ADAMS</u>				
					MATERIAL DESCRIPTION				
0		[Disturbed or Bag Sample Symbol]		SC	UNDOCUMENTED FILL (Qudf) Medium dense, damp, yellowish brown, Clayey SAND; trace cobble				
2									
4									
6						TRENCH TERMINATED AT 6 FEET			

Figure A-17,
Log of Trench T 17, Page 1 of 1

G2070-42-02.GPJ

SAMPLE SYMBOLS	 ... SAMPLING UNSUCCESSFUL	 ... STANDARD PENETRATION TEST	 ... DRIVE SAMPLE (UNDISTURBED)
	 ... DISTURBED OR BAG SAMPLE	 ... CHUNK SAMPLE	 ... WATER TABLE OR SEEPAGE

NOTE: THE LOG OF SUBSURFACE CONDITIONS SHOWN HEREON APPLIES ONLY AT THE SPECIFIC BORING OR TRENCH LOCATION AND AT THE DATE INDICATED. IT IS NOT WARRANTED TO BE REPRESENTATIVE OF SUBSURFACE CONDITIONS AT OTHER LOCATIONS AND TIMES.

DEPTH IN FEET	SAMPLE NO.	LITHOLOGY	GROUNDWATER	SOIL CLASS (USCS)	TRENCH T 18		PENETRATION RESISTANCE (BLOWS/FT.)	DRY DENSITY (P.C.F.)	MOISTURE CONTENT (%)
					ELEV. (MSL.) <u>288'</u>	DATE COMPLETED <u>06-13-2017</u>			
					EQUIPMENT <u>RUBBER TIRE BACKHOE</u> BY: <u>R. ADAMS</u>				
					MATERIAL DESCRIPTION				
0				GW	STADIUM CONGLOMERATE (Tst) Very dense, damp, fine to coarse, Sandy CONGLOMERATE; well cemented				
2					TRENCH TERMINATED AT 3 FEET				

Figure A-18,
Log of Trench T 18, Page 1 of 1

G2070-42-02.GPJ

SAMPLE SYMBOLS	... SAMPLING UNSUCCESSFUL	... STANDARD PENETRATION TEST	... DRIVE SAMPLE (UNDISTURBED)
	... DISTURBED OR BAG SAMPLE	... CHUNK SAMPLE	... WATER TABLE OR SEEPAGE

NOTE: THE LOG OF SUBSURFACE CONDITIONS SHOWN HEREON APPLIES ONLY AT THE SPECIFIC BORING OR TRENCH LOCATION AND AT THE DATE INDICATED. IT IS NOT WARRANTED TO BE REPRESENTATIVE OF SUBSURFACE CONDITIONS AT OTHER LOCATIONS AND TIMES.

DEPTH IN FEET	SAMPLE NO.	LITHOLOGY	GROUNDWATER	SOIL CLASS (USCS)	TRENCH T 19		PENETRATION RESISTANCE (BLOWS/FT.)	DRY DENSITY (P.C.F.)	MOISTURE CONTENT (%)
					ELEV. (MSL.) 282'	DATE COMPLETED 06-14-2017			
					EQUIPMENT RUBBER TIRE BACKHOE		BY: R. ADAMS		
MATERIAL DESCRIPTION									
0	T19-1			SM	UNDOCUMENTED FILL (Qudf)				
2			GP	Loose, dry, pale yellow-brown, Silty, fine SAND; trace gravel					
4			SM	Loose, damp to moist, brown to yellow brown, Sandy GRAVEL; 3/4-inch size					
6									
8									
10	T19-2			SW	Medium dense, damp, dark brown to gray to black, medium SAND with 10-15% cobble up to 12-inches				
12									
14			SW	Medium dense, damp, to moist, dark brown to orange, medium to coarse SAND with ±15% cobble and boulders up to 18-inches in diameter					
16									
TRENCH TERMINATED AT 17 FEET									

Figure A-19,
Log of Trench T 19, Page 1 of 1

G2070-42-02.GPJ

SAMPLE SYMBOLS		... SAMPLING UNSUCCESSFUL		... STANDARD PENETRATION TEST		... DRIVE SAMPLE (UNDISTURBED)
		... DISTURBED OR BAG SAMPLE		... CHUNK SAMPLE		... WATER TABLE OR SEEPAGE

NOTE: THE LOG OF SUBSURFACE CONDITIONS SHOWN HEREON APPLIES ONLY AT THE SPECIFIC BORING OR TRENCH LOCATION AND AT THE DATE INDICATED. IT IS NOT WARRANTED TO BE REPRESENTATIVE OF SUBSURFACE CONDITIONS AT OTHER LOCATIONS AND TIMES.







DEPTH IN FEET	SAMPLE NO.	LITHOLOGY	GROUNDWATER	SOIL CLASS (USCS)	TRENCH T 20		PENETRATION RESISTANCE (BLOWS/FT.)	DRY DENSITY (P.C.F.)	MOISTURE CONTENT (%)
					ELEV. (MSL.) <u>279'</u>	DATE COMPLETED <u>06-14-2017</u>			
					EQUIPMENT <u>RUBBER TIRE BACKHOE</u>		BY: <u>R. ADAMS</u>		
MATERIAL DESCRIPTION									
0				SM	UNDOCUMENTED FILL (Qudf) Medium dense, damp, yellowish brown to orange brown, Silty, fine to coarse SAND; some clay and trace angular gravel				
2				GM	STADIUM CONGLOMERATE (Tst) Very dense, dry to damp, medium, Sandy CONGLOMERATE; well cemented; difficult excavation				
4					TRENCH TERMINATED AT 4 FEET				

Figure A-20,
Log of Trench T 20, Page 1 of 1

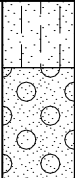
G2070-42-02.GPJ

SAMPLE SYMBOLS	 ... SAMPLING UNSUCCESSFUL	 ... STANDARD PENETRATION TEST	 ... DRIVE SAMPLE (UNDISTURBED)
	 ... DISTURBED OR BAG SAMPLE	 ... CHUNK SAMPLE	 ... WATER TABLE OR SEEPAGE

NOTE: THE LOG OF SUBSURFACE CONDITIONS SHOWN HEREON APPLIES ONLY AT THE SPECIFIC BORING OR TRENCH LOCATION AND AT THE DATE INDICATED. IT IS NOT WARRANTED TO BE REPRESENTATIVE OF SUBSURFACE CONDITIONS AT OTHER LOCATIONS AND TIMES.

DEPTH IN FEET	SAMPLE NO.	LITHOLOGY	GROUNDWATER	SOIL CLASS (USCS)	TRENCH T 21		PENETRATION RESISTANCE (BLOWS/FT.)	DRY DENSITY (P.C.F.)	MOISTURE CONTENT (%)
					ELEV. (MSL.) <u>273'</u>	DATE COMPLETED <u>06-14-2017</u>			
					EQUIPMENT <u>RUBBER TIRE BACKHOE</u>		BY: <u>R. ADAMS</u>		
MATERIAL DESCRIPTION									
0		○		GW	UNDOCUMENTED FILL (Qudf) Medium dense, dry, pale brown, Silty GRAVEL; 3/4-inch				
2		⊗		SP	COMPACTED FILL (Qcf) Medium dense, damp to moist, orange brown, fine to medium SAND; trace angular gravel, concrete slag and scrap metal present				
4					REFUSAL AT 4.75 FEET ON CONCRETE				

Figure A-21,
Log of Trench T 21, Page 1 of 1

G2070-42-02.GPJ

SAMPLE SYMBOLS	■ ... SAMPLING UNSUCCESSFUL	□ ... STANDARD PENETRATION TEST	■ ... DRIVE SAMPLE (UNDISTURBED)
	⊗ ... DISTURBED OR BAG SAMPLE	▣ ... CHUNK SAMPLE	▼ ... WATER TABLE OR SEEPAGE

NOTE: THE LOG OF SUBSURFACE CONDITIONS SHOWN HEREON APPLIES ONLY AT THE SPECIFIC BORING OR TRENCH LOCATION AND AT THE DATE INDICATED. IT IS NOT WARRANTED TO BE REPRESENTATIVE OF SUBSURFACE CONDITIONS AT OTHER LOCATIONS AND TIMES.

DEPTH IN FEET	SAMPLE NO.	LITHOLOGY	GROUNDWATER	SOIL CLASS (USCS)	TRENCH T 22		PENETRATION RESISTANCE (BLOWS/FT.)	DRY DENSITY (P.C.F.)	MOISTURE CONTENT (%)
					ELEV. (MSL.) <u>274'</u>	DATE COMPLETED <u>06-14-2017</u>			
					EQUIPMENT <u>RUBBER TIRE BACKHOE</u>		BY: <u>R. ADAMS</u>		
MATERIAL DESCRIPTION									
0	T22-1			SC	UNDOCUMENTED FILL (Qudf) Medium dense, dry to damp, orange brown, Clayey SAND with ±15% 3/4-inch gravel				
2				SC&SM	COMPACTED FILL (Qcf) Medium dense, damp to moist, orange brown, Clayey, medium to coarse SAND to Silty SAND				
4						-Concrete chunks at 5 feet			
6					REFUSAL AT 7 FEET ON CONCRETE				

Figure A-22,
Log of Trench T 22, Page 1 of 1

G2070-42-02.GPJ

SAMPLE SYMBOLS	... SAMPLING UNSUCCESSFUL	... STANDARD PENETRATION TEST	... DRIVE SAMPLE (UNDISTURBED)
	... DISTURBED OR BAG SAMPLE	... CHUNK SAMPLE	... WATER TABLE OR SEEPAGE

NOTE: THE LOG OF SUBSURFACE CONDITIONS SHOWN HEREON APPLIES ONLY AT THE SPECIFIC BORING OR TRENCH LOCATION AND AT THE DATE INDICATED. IT IS NOT WARRANTED TO BE REPRESENTATIVE OF SUBSURFACE CONDITIONS AT OTHER LOCATIONS AND TIMES.

DEPTH IN FEET	SAMPLE NO.	LITHOLOGY	GROUNDWATER	SOIL CLASS (USCS)	TRENCH T 23		PENETRATION RESISTANCE (BLOWS/FT.)	DRY DENSITY (P.C.F.)	MOISTURE CONTENT (%)
					ELEV. (MSL.) <u>273'</u>	DATE COMPLETED <u>06-14-2017</u>			
					EQUIPMENT <u>RUBBER TIRE BACKHOE</u>		BY: <u>R. ADAMS</u>		
MATERIAL DESCRIPTION									
0				SM	UNDOCUMENTED FILL (Qudf) Loose to medium dense, dry to damp, Silty, fine to medium SAND with some gravel and cobble				
2				GM	STADIUM CONGLOMERATE (Tst) Very dense, damp, pale yellowish brown to gray brown, fine to medium, Sandy CONGLOMERATE; highly cemented				
4					TRENCH TERMINATED AT 5 FEET				

Figure A-23,
Log of Trench T 23, Page 1 of 1

G2070-42-02.GPJ

SAMPLE SYMBOLS		... SAMPLING UNSUCCESSFUL		... STANDARD PENETRATION TEST		... DRIVE SAMPLE (UNDISTURBED)
		... DISTURBED OR BAG SAMPLE		... CHUNK SAMPLE		... WATER TABLE OR SEEPAGE

NOTE: THE LOG OF SUBSURFACE CONDITIONS SHOWN HEREON APPLIES ONLY AT THE SPECIFIC BORING OR TRENCH LOCATION AND AT THE DATE INDICATED. IT IS NOT WARRANTED TO BE REPRESENTATIVE OF SUBSURFACE CONDITIONS AT OTHER LOCATIONS AND TIMES.

DEPTH IN FEET	SAMPLE NO.	LITHOLOGY	GROUNDWATER	SOIL CLASS (USCS)	TRENCH T 24		PENETRATION RESISTANCE (BLOWS/FT.)	DRY DENSITY (P.C.F.)	MOISTURE CONTENT (%)
					ELEV. (MSL.) <u>275'</u>	DATE COMPLETED <u>06-14-2017</u>			
					EQUIPMENT <u>RUBBER TIRE BACKHOE</u>		BY: <u>R. ADAMS</u>		
MATERIAL DESCRIPTION									
0	T-24			SP	UNDOCUMENTED FILL (Qudf) Medium dense, dry to damp, gray to whitish gray, fine to medium SAND; trace silt and gravel				
2									
4				SM	COMPACTED FILL (Qcf) Dense, damp, brown, Silty, fine medium SAND; cemented				
					PRACTICAL REFUSAL AT 5 FEET				

Figure A-24,
Log of Trench T 24, Page 1 of 1

G2070-42-02.GPJ

SAMPLE SYMBOLS		... SAMPLING UNSUCCESSFUL		... STANDARD PENETRATION TEST		... DRIVE SAMPLE (UNDISTURBED)
		... DISTURBED OR BAG SAMPLE		... CHUNK SAMPLE		... WATER TABLE OR SEEPAGE

NOTE: THE LOG OF SUBSURFACE CONDITIONS SHOWN HEREON APPLIES ONLY AT THE SPECIFIC BORING OR TRENCH LOCATION AND AT THE DATE INDICATED. IT IS NOT WARRANTED TO BE REPRESENTATIVE OF SUBSURFACE CONDITIONS AT OTHER LOCATIONS AND TIMES.









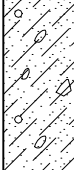
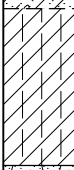

DEPTH IN FEET	SAMPLE NO.	LITHOLOGY	GROUNDWATER	SOIL CLASS (USCS)	TRENCH T 25		PENETRATION RESISTANCE (BLOWS/FT.)	DRY DENSITY (P.C.F.)	MOISTURE CONTENT (%)
					ELEV. (MSL.) <u>283'</u>	DATE COMPLETED <u>06-14-2017</u>			
					EQUIPMENT <u>RUBBER TIRE BACKHOE</u>		BY: <u>R. ADAMS</u>		
MATERIAL DESCRIPTION									
0				SC	UNDOCUMENTED FILL (Qudf) Medium dense, damp to moist, orange brown, Clayey SAND with gravel and trace cobble <2-inches in diameter				
2				SM&SC	Medium dense, moist, orange brown to whitish brown, Silty to Clayey, fine to medium SAND with 10% cobble up to 8-inches				
4									
6									
8				GW	STADIUM CONGLOMERATE (Tst) Very dense, damp, whitish to yellowish brown, fine, Sandy CONGLOMERATE; highly cemented				
					TRENCH TERMINATED AT 8.5 FEET				

Figure A-25,
Log of Trench T 25, Page 1 of 1

G2070-42-02.GPJ







SAMPLE SYMBOLS		... SAMPLING UNSUCCESSFUL		... STANDARD PENETRATION TEST		... DRIVE SAMPLE (UNDISTURBED)
		... DISTURBED OR BAG SAMPLE		... CHUNK SAMPLE		... WATER TABLE OR SEEPAGE

NOTE: THE LOG OF SUBSURFACE CONDITIONS SHOWN HEREON APPLIES ONLY AT THE SPECIFIC BORING OR TRENCH LOCATION AND AT THE DATE INDICATED. IT IS NOT WARRANTED TO BE REPRESENTATIVE OF SUBSURFACE CONDITIONS AT OTHER LOCATIONS AND TIMES.

DEPTH IN FEET	SAMPLE NO.	LITHOLOGY	GROUNDWATER	SOIL CLASS (USCS)	TRENCH T 26		PENETRATION RESISTANCE (BLOWS/FT.)	DRY DENSITY (P.C.F.)	MOISTURE CONTENT (%)
					ELEV. (MSL.) <u>286'</u>	DATE COMPLETED <u>06-14-2017</u>			
					EQUIPMENT <u>RUBBER TIRE BACKHOE</u>		BY: <u>R. ADAMS</u>		
MATERIAL DESCRIPTION									
0				SM	UNDOCUMENTED FILL (Qudf) Loose, dry, yellowish-white, Silty, fine SAND with gravel				
2				SC	Loose to medium dense, damp to moist, orange brown, Clayey, fine to coarse SAND with <15% cobble and boulders up to 14-inches in diameter				
4									
6									
8				CL	Medium dense, moist, black, Sandy CLAY with cobble				
10				SC	Medium dense, moist, orange brown to grayish brown, Clayey SAND with <12% cobble up to 8-inches				
12									
14				SM	Medium dense, moist, orange brown, Silty, fine to coarse SAND with <10% cobble <6-inches				
16	T26-1								
TRENCH TERMINATED AT 17.5 FEET									

Figure A-26,
Log of Trench T 26, Page 1 of 1

G2070-42-02.GPJ

SAMPLE SYMBOLS	 ... SAMPLING UNSUCCESSFUL	 ... STANDARD PENETRATION TEST	 ... DRIVE SAMPLE (UNDISTURBED)
	 ... DISTURBED OR BAG SAMPLE	 ... CHUNK SAMPLE	 ... WATER TABLE OR SEEPAGE

NOTE: THE LOG OF SUBSURFACE CONDITIONS SHOWN HEREON APPLIES ONLY AT THE SPECIFIC BORING OR TRENCH LOCATION AND AT THE DATE INDICATED. IT IS NOT WARRANTED TO BE REPRESENTATIVE OF SUBSURFACE CONDITIONS AT OTHER LOCATIONS AND TIMES.







DEPTH IN FEET	SAMPLE NO.	LITHOLOGY	GROUNDWATER	SOIL CLASS (USCS)	TRENCH T 27		PENETRATION RESISTANCE (BLOWS/FT.)	DRY DENSITY (P.C.F.)	MOISTURE CONTENT (%)
					ELEV. (MSL.) <u>283'</u>	DATE COMPLETED <u>06-14-2017</u>			
					EQUIPMENT <u>RUBBER TIRE BACKHOE</u> BY: <u>R. ADAMS</u>				
MATERIAL DESCRIPTION									
0				GM	UNDOCUMENTED FILL (Qudf) Loose, dry to damp, grayish brown to brown, fine to medium, Sandy GRAVEL with 40-50% cobble and boulders up to 15-inches in diameter -Caving below 3 feet; voids observed between cobbles				
2									
4									
6									
8				SM	Medium dense, damp, orange brown to grayish brown, Silty, medium SAND with 15% cobble <12-inches				
TRENCH TERMINATED AT 9 FEET									

Figure A-27,
Log of Trench T 27, Page 1 of 1

G2070-42-02.GPJ

SAMPLE SYMBOLS	 ... SAMPLING UNSUCCESSFUL	 ... STANDARD PENETRATION TEST	 ... DRIVE SAMPLE (UNDISTURBED)
	 ... DISTURBED OR BAG SAMPLE	 ... CHUNK SAMPLE	 ... WATER TABLE OR SEEPAGE

NOTE: THE LOG OF SUBSURFACE CONDITIONS SHOWN HEREON APPLIES ONLY AT THE SPECIFIC BORING OR TRENCH LOCATION AND AT THE DATE INDICATED. IT IS NOT WARRANTED TO BE REPRESENTATIVE OF SUBSURFACE CONDITIONS AT OTHER LOCATIONS AND TIMES.

DEPTH IN FEET	SAMPLE NO.	LITHOLOGY	GROUNDWATER	SOIL CLASS (USCS)	TRENCH T 28		PENETRATION RESISTANCE (BLOWS/FT.)	DRY DENSITY (P.C.F.)	MOISTURE CONTENT (%)
					ELEV. (MSL.) <u>273'</u>	DATE COMPLETED <u>06-14-2017</u>			
					EQUIPMENT <u>RUBBER TIRE BACKHOE</u>		BY: <u>R. ADAMS</u>		
MATERIAL DESCRIPTION									
0				SM	UNDOCUMENTED FILL (Qudf) Loose to medium dense, damp to moist, orange brown, Silty, fine to coarse SAND with 15% cobble and boulders up to <18-inches diameter and angular pointed tile fragments present				
2									
4									
6				GM	STADIUM CONGLOMERATE (Tst) Very dense, damp, orange brown, fine to coarse, Sandy CONGLOMERATE; moderately cemented				
TRENCH TERMINATED AT 7 FEET									

Figure A-28,
Log of Trench T 28, Page 1 of 1

G2070-42-02.GPJ







SAMPLE SYMBOLS		... SAMPLING UNSUCCESSFUL		... STANDARD PENETRATION TEST		... DRIVE SAMPLE (UNDISTURBED)
		... DISTURBED OR BAG SAMPLE		... CHUNK SAMPLE		... WATER TABLE OR SEEPAGE

NOTE: THE LOG OF SUBSURFACE CONDITIONS SHOWN HEREON APPLIES ONLY AT THE SPECIFIC BORING OR TRENCH LOCATION AND AT THE DATE INDICATED. IT IS NOT WARRANTED TO BE REPRESENTATIVE OF SUBSURFACE CONDITIONS AT OTHER LOCATIONS AND TIMES.

DEPTH IN FEET	SAMPLE NO.	LITHOLOGY	GROUNDWATER	SOIL CLASS (USCS)	TRENCH T 29		PENETRATION RESISTANCE (BLOWS/FT.)	DRY DENSITY (P.C.F.)	MOISTURE CONTENT (%)
					ELEV. (MSL.) <u>271'</u>	DATE COMPLETED <u>06-14-2017</u>			
					EQUIPMENT <u>RUBBER TIRE BACKHOE</u>		BY: <u>R. ADAMS</u>		
MATERIAL DESCRIPTION									
0				SC	UNDOCUMENTED FILL (Qudf) Medium dense, damp, orange brown, Clayey, medium to coarse SAND with 8% cobble, abundant trash, wood, plastic, rubber, metal and strong odor				
2									
4				SC	Medium dense, damp, dark gray to grayish black, Clayey SAND with ±5% cobble up to <6-inches in diameter; moderate to strong odor; large stump/pole at 5.5 feet				
6									
8				CL	Stiff, moist, grayish brown to orange brown, Sandy CLAY with cobble				
10									
12	T29-1			SC	Medium dense, moist to wet dark reddish brown, Clayey SAND with 10% cobble up to <10-inches in diameter; slight odor				
14				SC	-At 13 feet becomes brown to grayish brown Medium dense, damp to moist, orange brown, Clayey SAND with ±10-12% cobble <10-inches in diameter				
TRENCH TERMINATED AT 15.5 FEET									

Figure A-29,
Log of Trench T 29, Page 1 of 1

G2070-42-02.GPJ

SAMPLE SYMBOLS	 ... SAMPLING UNSUCCESSFUL	 ... STANDARD PENETRATION TEST	 ... DRIVE SAMPLE (UNDISTURBED)
	 ... DISTURBED OR BAG SAMPLE	 ... CHUNK SAMPLE	 ... WATER TABLE OR SEEPAGE

NOTE: THE LOG OF SUBSURFACE CONDITIONS SHOWN HEREON APPLIES ONLY AT THE SPECIFIC BORING OR TRENCH LOCATION AND AT THE DATE INDICATED. IT IS NOT WARRANTED TO BE REPRESENTATIVE OF SUBSURFACE CONDITIONS AT OTHER LOCATIONS AND TIMES.

DEPTH IN FEET	SAMPLE NO.	LITHOLOGY	GROUNDWATER	SOIL CLASS (USCS)	TRENCH T 30		PENETRATION RESISTANCE (BLOWS/FT.)	DRY DENSITY (P.C.F.)	MOISTURE CONTENT (%)
					ELEV. (MSL.) <u>270'</u>	DATE COMPLETED <u>06-14-2017</u>			
					EQUIPMENT <u>RUBBER TIRE BACKHOE</u>		BY: <u>R. ADAMS</u>		
MATERIAL DESCRIPTION									
0				SM	UNDOCUMENTED FILL (Qudf) Loose, dry, gray to pale brown, Silty SAND with gravel				
2			SC	Medium dense, damp to moist, grayish brown to orange brown and black brown, Clayey, medium to coarse SAND with <12% cobble and boulders up to 14-inches in diameter					
4				CL	Stiff, moist, dark brown to black, Sandy CLAY; with cobble and slight odor				
6									
8									
10									
12									
14									
16									
TRENCH TERMINATED AT 17 FEET									

Figure A-30,
Log of Trench T 30, Page 1 of 1

G2070-42-02.GPJ

SAMPLE SYMBOLS		... SAMPLING UNSUCCESSFUL		... STANDARD PENETRATION TEST		... DRIVE SAMPLE (UNDISTURBED)
		... DISTURBED OR BAG SAMPLE		... CHUNK SAMPLE		... WATER TABLE OR SEEPAGE

NOTE: THE LOG OF SUBSURFACE CONDITIONS SHOWN HEREON APPLIES ONLY AT THE SPECIFIC BORING OR TRENCH LOCATION AND AT THE DATE INDICATED. IT IS NOT WARRANTED TO BE REPRESENTATIVE OF SUBSURFACE CONDITIONS AT OTHER LOCATIONS AND TIMES.

DEPTH IN FEET	SAMPLE NO.	LITHOLOGY	GROUNDWATER	SOIL CLASS (USCS)	TRENCH T 31		PENETRATION RESISTANCE (BLOWS/FT.)	DRY DENSITY (P.C.F.)	MOISTURE CONTENT (%)	
					ELEV. (MSL.) <u>269'</u>	DATE COMPLETED <u>06-14-2017</u>				
					EQUIPMENT <u>RUBBER TIRE BACKHOE</u>		BY: <u>R. ADAMS</u>			
MATERIAL DESCRIPTION										
0				GM	UNDOCUMENTED FILL (Qudf)					
				SC	Loose to medium dense, dry, gray, Silty GRAVEL; 3/4" rock					
2					Medium dense, damp, orange brown to grayish brown, Clayey, fine to medium SAND with 12% cobble up to 10-inches in diameter					
4										
6										
8						-Becomes black to very dark gray with organic debris; strong odor				
10										
12						-At 11 feet becomes moist to wet with 4-6-inch wood fragments				
14						-At 13 feet 3/4-inch gravel observed				
16						-At 15 feet becomes wet with light seepage in sidewall				
					CL	Medium dense, wet, greenish gray, Sandy CLAY with cobble; slight odor				
TRENCH TERMINATED AT 17 FEET										

Figure A-31,
Log of Trench T 31, Page 1 of 1

G2070-42-02.GPJ

SAMPLE SYMBOLS		... SAMPLING UNSUCCESSFUL		... STANDARD PENETRATION TEST		... DRIVE SAMPLE (UNDISTURBED)
		... DISTURBED OR BAG SAMPLE		... CHUNK SAMPLE		... WATER TABLE OR SEEPAGE

NOTE: THE LOG OF SUBSURFACE CONDITIONS SHOWN HEREON APPLIES ONLY AT THE SPECIFIC BORING OR TRENCH LOCATION AND AT THE DATE INDICATED. IT IS NOT WARRANTED TO BE REPRESENTATIVE OF SUBSURFACE CONDITIONS AT OTHER LOCATIONS AND TIMES.

DEPTH IN FEET	SAMPLE NO.	LITHOLOGY	GROUNDWATER	SOIL CLASS (USCS)	TRENCH T 32		PENETRATION RESISTANCE (BLOWS/FT.)	DRY DENSITY (P.C.F.)	MOISTURE CONTENT (%)
					ELEV. (MSL.) 268'	DATE COMPLETED 06-14-2017			
					EQUIPMENT RUBBER TIRE BACKHOE		BY: R. ADAMS		
MATERIAL DESCRIPTION									
0				SM	UNDOCUMENTED FILL (Qudf) Loose, dry, whitish gray, Silty, fine SAND with gravel; 3/4" rock				
2			SC	Medium dense, damp, orange brown to brown, Clayey, fine to coarse SAND with <10% cobble up to 8-inches in diameter					
4			SC	Medium dense, damp, black to dark brown, Clayey SAND with cobble up to 6-inches in diameter					
6						-At 7 feet 1-inch electrical conduit observed			
8			SC	Medium dense, damp to moist, brown to orange brown, Clayey, fine to coarse SAND with <10% cobble up to 6-inches in diameter					
10									
12									
14					-At 13 feet, 20-inch concrete chunk present -At 14 feet, asphalt and concrete chunks present				
16					TRENCH TERMINATED AT 16 FEET				

Figure A-32,
Log of Trench T 32, Page 1 of 1

G2070-42-02.GPJ

SAMPLE SYMBOLS		... SAMPLING UNSUCCESSFUL		... STANDARD PENETRATION TEST		... DRIVE SAMPLE (UNDISTURBED)
		... DISTURBED OR BAG SAMPLE		... CHUNK SAMPLE		... WATER TABLE OR SEEPAGE

NOTE: THE LOG OF SUBSURFACE CONDITIONS SHOWN HEREON APPLIES ONLY AT THE SPECIFIC BORING OR TRENCH LOCATION AND AT THE DATE INDICATED. IT IS NOT WARRANTED TO BE REPRESENTATIVE OF SUBSURFACE CONDITIONS AT OTHER LOCATIONS AND TIMES.







DEPTH IN FEET	SAMPLE NO.	LITHOLOGY	GROUNDWATER	SOIL CLASS (USCS)	TRENCH T 33		PENETRATION RESISTANCE (BLOWS/FT.)	DRY DENSITY (P.C.F.)	MOISTURE CONTENT (%)	
					ELEV. (MSL.) <u>263'</u>	DATE COMPLETED <u>06-14-2017</u>				
					EQUIPMENT <u>RUBBER TIRE BACKHOE</u>		BY: <u>R. ADAMS</u>			
MATERIAL DESCRIPTION										
0	T33-1			SM	UNDOCUMENTED FILL (Qudf) Loose, dry, grayish white, Silty, fine SAND with 3/4" gravel					
2				SC	Loose to medium dense, damp to moist, orange brown, Clayey, medium to coarse SAND; with some 3/4" gravel and trace cobble					
4					CL	ALLUVIUM (Qal) Soft, moist to wet, dark brown, Sandy, CLAY; with <8% cobble up to 6-inches in diameter -At 12 feet light to moderate seepage -At 13 feet heavy seepage and standing water				
6										
8										
10										
12										
14					TRENCH TERMINATED AT 14 FEET					

Figure A-33,
Log of Trench T 33, Page 1 of 1

G2070-42-02.GPJ

SAMPLE SYMBOLS		... SAMPLING UNSUCCESSFUL		... STANDARD PENETRATION TEST		... DRIVE SAMPLE (UNDISTURBED)
		... DISTURBED OR BAG SAMPLE		... CHUNK SAMPLE		... WATER TABLE OR SEEPAGE

NOTE: THE LOG OF SUBSURFACE CONDITIONS SHOWN HEREON APPLIES ONLY AT THE SPECIFIC BORING OR TRENCH LOCATION AND AT THE DATE INDICATED. IT IS NOT WARRANTED TO BE REPRESENTATIVE OF SUBSURFACE CONDITIONS AT OTHER LOCATIONS AND TIMES.

DEPTH IN FEET	SAMPLE NO.	LITHOLOGY	GROUNDWATER	SOIL CLASS (USCS)	TRENCH T 34		PENETRATION RESISTANCE (BLOWS/FT.)	DRY DENSITY (P.C.F.)	MOISTURE CONTENT (%)
					ELEV. (MSL.) <u>266'</u>	DATE COMPLETED <u>06-14-2017</u>			
					EQUIPMENT <u>RUBBER TIRE BACKHOE</u> BY: <u>R. ADAMS</u>				
					MATERIAL DESCRIPTION				
0				SM	UNDOCUMENTED FILL (Qudf) Loose, dry, light gray, Silty, fine SAND with gravel				
2				ML	ALLUVIUM (Qal) Stiff, dry to damp, brown to reddish brown, Sandy SILT; few cobble <8-inches in diameter and concrete chunks				
4	T34-1					-Becomes soft with 10-25% cobble at 8 feet			
6									
8									
10				SM	Loose, dry, brown to grayish brown, Silty, fine SAND with some cobble up to 12-inches; trench collapsed during excavation				
12					TRENCH TERMINATED AT 12 FEET DUE TO CAVING				

Figure A-34,
Log of Trench T 34, Page 1 of 1

G2070-42-02.GPJ

SAMPLE SYMBOLS		... SAMPLING UNSUCCESSFUL		... STANDARD PENETRATION TEST		... DRIVE SAMPLE (UNDISTURBED)
		... DISTURBED OR BAG SAMPLE		... CHUNK SAMPLE		... WATER TABLE OR SEEPAGE

NOTE: THE LOG OF SUBSURFACE CONDITIONS SHOWN HEREON APPLIES ONLY AT THE SPECIFIC BORING OR TRENCH LOCATION AND AT THE DATE INDICATED. IT IS NOT WARRANTED TO BE REPRESENTATIVE OF SUBSURFACE CONDITIONS AT OTHER LOCATIONS AND TIMES.

DEPTH IN FEET	SAMPLE NO.	LITHOLOGY	GROUNDWATER	SOIL CLASS (USCS)	TRENCH T 35		PENETRATION RESISTANCE (BLOWS/FT.)	DRY DENSITY (P.C.F.)	MOISTURE CONTENT (%)
					ELEV. (MSL.) <u>269'</u>	DATE COMPLETED <u>06-15-2017</u>			
					EQUIPMENT <u>RUBBER TIRE BACKHOE</u>		BY: <u>R. ADAMS</u>		
MATERIAL DESCRIPTION									
0				SM	UNDOCUMENTED FILL (Qudf) Loose to medium dense, dry, grayish white, Silty, fine SAND with gravel				
2			SC	Medium dense, dry to damp, brown to grayish brown, Clayey, fine to coarse SAND with <10% cobble up to 10-inches in diameter					
4									
6									
8									
10				SM	Medium dense, moist to wet, brown, Silty, medium to coarse SAND with <15% cobble up to 12-inches and trace clay				
12									
14									
16					TRENCH TERMINATED AT 16.5 FEET				

Figure A-35,
Log of Trench T 35, Page 1 of 1

G2070-42-02.GPJ

SAMPLE SYMBOLS		... SAMPLING UNSUCCESSFUL		... STANDARD PENETRATION TEST		... DRIVE SAMPLE (UNDISTURBED)
		... DISTURBED OR BAG SAMPLE		... CHUNK SAMPLE		... WATER TABLE OR SEEPAGE

NOTE: THE LOG OF SUBSURFACE CONDITIONS SHOWN HEREON APPLIES ONLY AT THE SPECIFIC BORING OR TRENCH LOCATION AND AT THE DATE INDICATED. IT IS NOT WARRANTED TO BE REPRESENTATIVE OF SUBSURFACE CONDITIONS AT OTHER LOCATIONS AND TIMES.

DEPTH IN FEET	SAMPLE NO.	LITHOLOGY	GROUNDWATER	SOIL CLASS (USCS)	TRENCH T 36		PENETRATION RESISTANCE (BLOWS/FT.)	DRY DENSITY (P.C.F.)	MOISTURE CONTENT (%)
					ELEV. (MSL.) <u>253'</u>	DATE COMPLETED <u>06-15-2017</u>			
					EQUIPMENT <u>RUBBER TIRE BACKHOE</u>		BY: <u>R. ADAMS</u>		
MATERIAL DESCRIPTION									
0				SM	UNDOCUMENTED FILL (Qudf) Loose to medium dense, dry to moist, brown to pale yellowish brown, Silty, fine to medium SAND with few cobble up to 8-inches in diameter; asphalt and concrete debris present				
2									
4				SM	ALLUVIUM (Qal) Loose, damp to wet, pale yellowish brown, Silty, fine to medium SAND with some cobble up to 14-inches in diameter; minor caving				
6									
8				GM	STADIUM CONGLOMERATE (Tst) Dense, moist to wet, whitish brown to yellow brown, mottled, fine to coarse, Sandy CONGLOMERATE; trace silt; well cemented				
10									
12					-Seepage at 10 feet				
TRENCH TERMINATED AT 13 FEET									

Figure A-36,
Log of Trench T 36, Page 1 of 1

G2070-42-02.GPJ







SAMPLE SYMBOLS		... SAMPLING UNSUCCESSFUL		... STANDARD PENETRATION TEST		... DRIVE SAMPLE (UNDISTURBED)
		... DISTURBED OR BAG SAMPLE		... CHUNK SAMPLE		... WATER TABLE OR SEEPAGE

NOTE: THE LOG OF SUBSURFACE CONDITIONS SHOWN HEREON APPLIES ONLY AT THE SPECIFIC BORING OR TRENCH LOCATION AND AT THE DATE INDICATED. IT IS NOT WARRANTED TO BE REPRESENTATIVE OF SUBSURFACE CONDITIONS AT OTHER LOCATIONS AND TIMES.

DEPTH IN FEET	SAMPLE NO.	LITHOLOGY	GROUNDWATER	SOIL CLASS (USCS)	TRENCH T 37		PENETRATION RESISTANCE (BLOWS/FT.)	DRY DENSITY (P.C.F.)	MOISTURE CONTENT (%)
					ELEV. (MSL.) <u>274'</u>	DATE COMPLETED <u>06-15-2017</u>			
					EQUIPMENT <u>RUBBER TIRE BACKHOE</u>		BY: <u>R. ADAMS</u>		
MATERIAL DESCRIPTION									
0				SM	UNDOCUMENTED FILL (Qudf) Medium dense, damp, brown Silty, fine to medium SAND; trace clay and cobble <4-inches and 3/4" gravel				
2				SP	COMPACTED FILL (Qcf) Medium dense, damp to moist, orange brown, medium to coarse SAND; trace clay and angular rock fragments with abundant concrete fragments				
4									
6									
8					-1 foot lens of concrete debris at 8 feet				
10									
12					-At 12 feet becomes difficult to excavate				
14					PRACTICAL REFUSAL AT 14 FEET				

Figure A-37,
Log of Trench T 37, Page 1 of 1

G2070-42-02.GPJ

SAMPLE SYMBOLS	 ... SAMPLING UNSUCCESSFUL	 ... STANDARD PENETRATION TEST	 ... DRIVE SAMPLE (UNDISTURBED)
	 ... DISTURBED OR BAG SAMPLE	 ... CHUNK SAMPLE	 ... WATER TABLE OR SEEPAGE

NOTE: THE LOG OF SUBSURFACE CONDITIONS SHOWN HEREON APPLIES ONLY AT THE SPECIFIC BORING OR TRENCH LOCATION AND AT THE DATE INDICATED. IT IS NOT WARRANTED TO BE REPRESENTATIVE OF SUBSURFACE CONDITIONS AT OTHER LOCATIONS AND TIMES.

DEPTH IN FEET	SAMPLE NO.	LITHOLOGY	GROUNDWATER	SOIL CLASS (USCS)	TRENCH T 38		PENETRATION RESISTANCE (BLOWS/FT.)	DRY DENSITY (P.C.F.)	MOISTURE CONTENT (%)
					ELEV. (MSL.) <u>281'</u>	DATE COMPLETED <u>06-15-2017</u>			
					EQUIPMENT <u>RUBBER TIRE BACKHOE</u>		BY: <u>R. ADAMS</u>		
MATERIAL DESCRIPTION									
0				SM	UNDOCUMENTED FILL (Qudf) Loose, dry, grayish white, Silty, fine SAND with gravel				
2			SC	COMPACTED FILL (Qcf) Medium dense, moist, orange-brown, Clayey, fine to coarse SAND; trace rock fragments					
4									
6									
8									
10									
12									
14									
16									
TRENCH TERMINATED AT 17 FEET									

Figure A-38,
Log of Trench T 38, Page 1 of 1

G2070-42-02.GPJ







SAMPLE SYMBOLS		... SAMPLING UNSUCCESSFUL		... STANDARD PENETRATION TEST		... DRIVE SAMPLE (UNDISTURBED)
		... DISTURBED OR BAG SAMPLE		... CHUNK SAMPLE		... WATER TABLE OR SEEPAGE

NOTE: THE LOG OF SUBSURFACE CONDITIONS SHOWN HEREON APPLIES ONLY AT THE SPECIFIC BORING OR TRENCH LOCATION AND AT THE DATE INDICATED. IT IS NOT WARRANTED TO BE REPRESENTATIVE OF SUBSURFACE CONDITIONS AT OTHER LOCATIONS AND TIMES.

DEPTH IN FEET	SAMPLE NO.	LITHOLOGY	GROUNDWATER	SOIL CLASS (USCS)	TRENCH T 39		PENETRATION RESISTANCE (BLOWS/FT.)	DRY DENSITY (P.C.F.)	MOISTURE CONTENT (%)
					ELEV. (MSL.) <u>275'</u>	DATE COMPLETED <u>06-15-2017</u>			
					EQUIPMENT <u>RUBBER TIRE BACKHOE</u>		BY: <u>R. ADAMS</u>		
MATERIAL DESCRIPTION									
0				ML	UNDOCUMENTED FILL (Qudf) Loose, dry, grayish white, Sandy SILT; few cobble up to 6-inches in diameter				
2				SC	Loose to medium dense, damp, brown to reddish brown, Clayey, medium to coarse SAND with 10-15% cobble up to 10-inches in diameter				
4									
6									
8				SC	Medium dense, damp to moist, grayish brown to brown, Clayey, fine to coarse SAND with some cobble up to 12-inches in diameter and trace boulders				
10									
12									
14									
16				SC	ALLUVIUM (Qal) Medium dense, damp to moist, orange brown, Clayey, medium to coarse SAND with some cobble up to 8-inches in diameter				
					TRENCH TERMINATED AT 17 FEET				

Figure A-39,
Log of Trench T 39, Page 1 of 1

G2070-42-02.GPJ

SAMPLE SYMBOLS	 ... SAMPLING UNSUCCESSFUL	 ... STANDARD PENETRATION TEST	 ... DRIVE SAMPLE (UNDISTURBED)
	 ... DISTURBED OR BAG SAMPLE	 ... CHUNK SAMPLE	 ... WATER TABLE OR SEEPAGE

NOTE: THE LOG OF SUBSURFACE CONDITIONS SHOWN HEREON APPLIES ONLY AT THE SPECIFIC BORING OR TRENCH LOCATION AND AT THE DATE INDICATED. IT IS NOT WARRANTED TO BE REPRESENTATIVE OF SUBSURFACE CONDITIONS AT OTHER LOCATIONS AND TIMES.

















DEPTH IN FEET	SAMPLE NO.	LITHOLOGY	GROUNDWATER	SOIL CLASS (USCS)	TRENCH T 40		PENETRATION RESISTANCE (BLOWS/FT.)	DRY DENSITY (P.C.F.)	MOISTURE CONTENT (%)
					ELEV. (MSL.) <u>285'</u>	DATE COMPLETED <u>06-15-2017</u>			
					EQUIPMENT <u>RUBBER TIRE BACKHOE</u>		BY: <u>R. ADAMS</u>		
MATERIAL DESCRIPTION									
0				SC	UNDOCUMENTED FILL (Qudf) Medium dense, damp, grayish brown, Clayey, fine to medium SAND; trace gravel				
2				ML	Medium dense, moist, pale yellowish brown to yellow brown, fine, Sandy SILT; trace wood debris and roots				
4									
6									
8				SC	Medium dense, damp to moist, grayish brown, Clayey, fine to medium SAND; trace cobble and some roots				
10					-Becomes gray and moist at 10 feet				
12									
14				CH	Very soft, moist, blackish-gray, Silty, CLAY; abundant organic debris including buried palm tree				
16					-At 16 feet becomes wet				
18					TRENCH TERMINATED AT 18 FEET				

Figure A-40,
Log of Trench T 40, Page 1 of 1

G2070-42-02.GPJ

SAMPLE SYMBOLS		... SAMPLING UNSUCCESSFUL		... STANDARD PENETRATION TEST		... DRIVE SAMPLE (UNDISTURBED)
		... DISTURBED OR BAG SAMPLE		... CHUNK SAMPLE		... WATER TABLE OR SEEPAGE

NOTE: THE LOG OF SUBSURFACE CONDITIONS SHOWN HEREON APPLIES ONLY AT THE SPECIFIC BORING OR TRENCH LOCATION AND AT THE DATE INDICATED. IT IS NOT WARRANTED TO BE REPRESENTATIVE OF SUBSURFACE CONDITIONS AT OTHER LOCATIONS AND TIMES.

DEPTH IN FEET	SAMPLE NO.	LITHOLOGY	GROUNDWATER	SOIL CLASS (USCS)	TRENCH T 41		PENETRATION RESISTANCE (BLOWS/FT.)	DRY DENSITY (P.C.F.)	MOISTURE CONTENT (%)	
					ELEV. (MSL.) <u>285'</u>	DATE COMPLETED <u>06-15-2017</u>				
					EQUIPMENT <u>RUBBER TIRE BACKHOE</u>		BY: <u>R. ADAMS</u>			
MATERIAL DESCRIPTION										
0				SC	UNDOCUMENTED FILL (Qudf) Medium dense, moist, orange brown, Clayey, fine to medium SAND; trace 1/2" gravel; some asphalt chunks and concrete chunks -At 5 feet extensive caving in bench sidewalls -At 6 feet roots and plant debris noted -At 7 feet moist to wet					
2										
4										
6										
8										
10					CH	Very soft, wet, brownish gray, plastic CLAY; abundant organics				
12						TRENCH TERMINATED AT 12 FEET DUE TO CAVING				

Figure A-41,
Log of Trench T 41, Page 1 of 1

G2070-42-02.GPJ

SAMPLE SYMBOLS		... SAMPLING UNSUCCESSFUL		... STANDARD PENETRATION TEST		... DRIVE SAMPLE (UNDISTURBED)
		... DISTURBED OR BAG SAMPLE		... CHUNK SAMPLE		... WATER TABLE OR SEEPAGE

NOTE: THE LOG OF SUBSURFACE CONDITIONS SHOWN HEREON APPLIES ONLY AT THE SPECIFIC BORING OR TRENCH LOCATION AND AT THE DATE INDICATED. IT IS NOT WARRANTED TO BE REPRESENTATIVE OF SUBSURFACE CONDITIONS AT OTHER LOCATIONS AND TIMES.







DEPTH IN FEET	SAMPLE NO.	LITHOLOGY	GROUNDWATER	SOIL CLASS (USCS)	TRENCH T 42		PENETRATION RESISTANCE (BLOWS/FT.)	DRY DENSITY (P.C.F.)	MOISTURE CONTENT (%)
					ELEV. (MSL.) <u>281'</u>	DATE COMPLETED <u>06-15-2017</u>			
					EQUIPMENT <u>RUBBER TIRE BACKHOE</u>		BY: <u>R. ADAMS</u>		
MATERIAL DESCRIPTION									
0				SM	UNDOCUMENTED FILL (Qudf) Loose, dry, pale brown, Silty, fine to medium SAND; trace gravel and cobble up to 8-inches				
2			SC	Medium dense, damp to moist, Clayey SAND; few cobble up to 8-inches in diameter					
4									
6					-Concrete slab at 6 feet				
					REFUSAL AT 6 FEET ON CONCRETE SLAB				

Figure A-42,
Log of Trench T 42, Page 1 of 1

G2070-42-02.GPJ

SAMPLE SYMBOLS		... SAMPLING UNSUCCESSFUL		... STANDARD PENETRATION TEST		... DRIVE SAMPLE (UNDISTURBED)
		... DISTURBED OR BAG SAMPLE		... CHUNK SAMPLE		... WATER TABLE OR SEEPAGE

NOTE: THE LOG OF SUBSURFACE CONDITIONS SHOWN HEREON APPLIES ONLY AT THE SPECIFIC BORING OR TRENCH LOCATION AND AT THE DATE INDICATED. IT IS NOT WARRANTED TO BE REPRESENTATIVE OF SUBSURFACE CONDITIONS AT OTHER LOCATIONS AND TIMES.







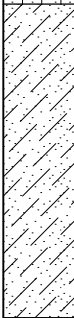

DEPTH IN FEET	SAMPLE NO.	LITHOLOGY	GROUNDWATER	SOIL CLASS (USCS)	TRENCH T 43		PENETRATION RESISTANCE (BLOWS/FT.)	DRY DENSITY (P.C.F.)	MOISTURE CONTENT (%)
					ELEV. (MSL.) <u>247'</u>	DATE COMPLETED <u>06-15-2017</u>			
					EQUIPMENT <u>RUBBER TIRE BACKHOE</u>		BY: <u>R. ADAMS</u>		
MATERIAL DESCRIPTION									
0				SM	UNDOCUMENTED FILL (Qudf) Loose, dry, yellowish brown, Silty, fine SAND with wood and metal debris and trace cobble				
2				SC	ALLUVIUM (Qal) Medium dense, dry to damp, Clayey, fine to medium SAND; trace clay and few cobble up to 8-inches in diameter -At 5 feet becomes reddish brown and moist				
4									
6									
8									
10				GM	STADIUM CONGLOMERATE (Tst) Dense, moist, whitish brown to yellow orange, fine to medium, Sandy CONGLOMERATE; moderately to well cemented with cobble and boulders up to 18-inches in diameter				
					TRENCH TERMINATED AT 10.5 FEET				

Figure A-43,
Log of Trench T 43, Page 1 of 1

G2070-42-02.GPJ







SAMPLE SYMBOLS	 ... SAMPLING UNSUCCESSFUL	 ... STANDARD PENETRATION TEST	 ... DRIVE SAMPLE (UNDISTURBED)
	 ... DISTURBED OR BAG SAMPLE	 ... CHUNK SAMPLE	 ... WATER TABLE OR SEEPAGE

NOTE: THE LOG OF SUBSURFACE CONDITIONS SHOWN HEREON APPLIES ONLY AT THE SPECIFIC BORING OR TRENCH LOCATION AND AT THE DATE INDICATED. IT IS NOT WARRANTED TO BE REPRESENTATIVE OF SUBSURFACE CONDITIONS AT OTHER LOCATIONS AND TIMES.

DEPTH IN FEET	SAMPLE NO.	LITHOLOGY	GROUNDWATER	SOIL CLASS (USCS)	TRENCH T 44		PENETRATION RESISTANCE (BLOWS/FT.)	DRY DENSITY (P.C.F.)	MOISTURE CONTENT (%)		
					ELEV. (MSL.) <u>238'</u>	DATE COMPLETED <u>06-15-2017</u>					
					EQUIPMENT <u>RUBBER TIRE BACKHOE</u>		BY: <u>R. ADAMS</u>				
MATERIAL DESCRIPTION											
0		[Lithology pattern]		SM	<p>UNDOCUMENTED FILL (Qudf) Loose to medium dense, dry to damp, orange brown, Silty, fine to medium SAND; few cobble up to 14-inches with roots present in upper 2 feet</p> <p>-Becomes slightly clayey at 6 feet</p>						
2											
4											
6											
8											
10											
TRENCH TERMINATE AT 11 FEET											

Figure A-44,
Log of Trench T 44, Page 1 of 1

G2070-42-02.GPJ







SAMPLE SYMBOLS	 ... SAMPLING UNSUCCESSFUL	 ... STANDARD PENETRATION TEST	 ... DRIVE SAMPLE (UNDISTURBED)
	 ... DISTURBED OR BAG SAMPLE	 ... CHUNK SAMPLE	 ... WATER TABLE OR SEEPAGE

NOTE: THE LOG OF SUBSURFACE CONDITIONS SHOWN HEREON APPLIES ONLY AT THE SPECIFIC BORING OR TRENCH LOCATION AND AT THE DATE INDICATED. IT IS NOT WARRANTED TO BE REPRESENTATIVE OF SUBSURFACE CONDITIONS AT OTHER LOCATIONS AND TIMES.

DEPTH IN FEET	SAMPLE NO.	LITHOLOGY	GROUNDWATER	SOIL CLASS (USCS)	TRENCH T 45		PENETRATION RESISTANCE (BLOWS/FT.)	DRY DENSITY (P.C.F.)	MOISTURE CONTENT (%)
					ELEV. (MSL.) <u>230'</u>	DATE COMPLETED <u>06-15-2017</u>			
					EQUIPMENT <u>RUBBER TIRE BACKHOE</u>		BY: <u>R. ADAMS</u>		
MATERIAL DESCRIPTION									
0				SC	UNDOCUMENTED FILL (Qudf) Loose, moist, orange brown, Clayey, fine to medium SAND; trace gravel and cobble				
2									
4									
6									
TRENCH TERMINATED AT 7 FEET									

Figure A-45,
Log of Trench T 45, Page 1 of 1

G2070-42-02.GPJ

SAMPLE SYMBOLS	 ... SAMPLING UNSUCCESSFUL	 ... STANDARD PENETRATION TEST	 ... DRIVE SAMPLE (UNDISTURBED)
	 ... DISTURBED OR BAG SAMPLE	 ... CHUNK SAMPLE	 ... WATER TABLE OR SEEPAGE

NOTE: THE LOG OF SUBSURFACE CONDITIONS SHOWN HEREON APPLIES ONLY AT THE SPECIFIC BORING OR TRENCH LOCATION AND AT THE DATE INDICATED. IT IS NOT WARRANTED TO BE REPRESENTATIVE OF SUBSURFACE CONDITIONS AT OTHER LOCATIONS AND TIMES.

DEPTH IN FEET	SAMPLE NO.	LITHOLOGY	GROUNDWATER	SOIL CLASS (USCS)	TRENCH T 46		PENETRATION RESISTANCE (BLOWS/FT.)	DRY DENSITY (P.C.F.)	MOISTURE CONTENT (%)
					ELEV. (MSL.) <u>297'</u>	DATE COMPLETED <u>06-15-2017</u>			
					EQUIPMENT <u>RUBBER TIRE BACKHOE</u> BY: <u>R. ADAMS</u>				
MATERIAL DESCRIPTION									
0				SM	UNDOCUMENTED FILL (Qudf) Loose, dry, pale yellowish brown, Silty, fine to coarse SAND; trace clay, cobble and gravel				
2				SC	Medium dense, damp to moist, orange brown, Clayey, medium to coarse SAND; trace gravel and cobble up to 6-inches				
4					-At 7 feet becomes moist to wet				
6									
8									
10									
12									
14				GW	STADIUM CONGLOMERATE (Tst) Dense, moist, grayish-white to orangish-white, Sandy CONGLOMERATE; weakly cemented				
					TRENCH TERMINATED AT 15 FEET				

Figure A-46,
Log of Trench T 46, Page 1 of 1

G2070-42-02.GPJ

SAMPLE SYMBOLS	... SAMPLING UNSUCCESSFUL	... STANDARD PENETRATION TEST	... DRIVE SAMPLE (UNDISTURBED)
	... DISTURBED OR BAG SAMPLE	... CHUNK SAMPLE	... WATER TABLE OR SEEPAGE

NOTE: THE LOG OF SUBSURFACE CONDITIONS SHOWN HEREON APPLIES ONLY AT THE SPECIFIC BORING OR TRENCH LOCATION AND AT THE DATE INDICATED. IT IS NOT WARRANTED TO BE REPRESENTATIVE OF SUBSURFACE CONDITIONS AT OTHER LOCATIONS AND TIMES.

DEPTH IN FEET	SAMPLE NO.	LITHOLOGY	GROUNDWATER	SOIL CLASS (USCS)	TRENCH T 47		PENETRATION RESISTANCE (BLOWS/FT.)	DRY DENSITY (P.C.F.)	MOISTURE CONTENT (%)	
					ELEV. (MSL.) <u>270'</u>	DATE COMPLETED <u>06-15-2017</u>				
					EQUIPMENT <u>RUBBER TIRE BACKHOE</u>		BY: <u>R. ADAMS</u>			
MATERIAL DESCRIPTION										
0				GM	UNDOCUMENTED FILL (Qudf) Loose, dry, brown to dark brown, Sandy GRAVEL with 40% gravel, cobble and boulders up to 18-inches in diameter					
2										
4										
6										
8										
10						-Caving at 10 feet limiting excavation progress				
12										
					TRENCH TERMINATED AT 13 FEET					

Figure A-47,
Log of Trench T 47, Page 1 of 1

G2070-42-02.GPJ

SAMPLE SYMBOLS		... SAMPLING UNSUCCESSFUL		... STANDARD PENETRATION TEST		... DRIVE SAMPLE (UNDISTURBED)
		... DISTURBED OR BAG SAMPLE		... CHUNK SAMPLE		... WATER TABLE OR SEEPAGE

NOTE: THE LOG OF SUBSURFACE CONDITIONS SHOWN HEREON APPLIES ONLY AT THE SPECIFIC BORING OR TRENCH LOCATION AND AT THE DATE INDICATED. IT IS NOT WARRANTED TO BE REPRESENTATIVE OF SUBSURFACE CONDITIONS AT OTHER LOCATIONS AND TIMES.

DEPTH IN FEET	SAMPLE NO.	LITHOLOGY	GROUNDWATER	SOIL CLASS (USCS)	TRENCH T 48		PENETRATION RESISTANCE (BLOWS/FT.)	DRY DENSITY (P.C.F.)	MOISTURE CONTENT (%)	
					ELEV. (MSL.) <u>259'</u>	DATE COMPLETED <u>06-15-2017</u>				
					EQUIPMENT <u>RUBBER TIRE BACKHOE</u> BY: <u>R. ADAMS</u>					
					MATERIAL DESCRIPTION					
0				SC	UNDOCUMENTED FILL (Qudf) Loose to medium dense, dry to damp, Clayey, fine to medium SAND with trace cobble up to 6-inches					
2										
4										
6					TRENCH TERMINATED AT 6 FEET					

Figure A-48,
Log of Trench T 48, Page 1 of 1

G2070-42-02.GPJ

SAMPLE SYMBOLS	... SAMPLING UNSUCCESSFUL	... STANDARD PENETRATION TEST	... DRIVE SAMPLE (UNDISTURBED)
	... DISTURBED OR BAG SAMPLE	... CHUNK SAMPLE	... WATER TABLE OR SEEPAGE

NOTE: THE LOG OF SUBSURFACE CONDITIONS SHOWN HEREON APPLIES ONLY AT THE SPECIFIC BORING OR TRENCH LOCATION AND AT THE DATE INDICATED. IT IS NOT WARRANTED TO BE REPRESENTATIVE OF SUBSURFACE CONDITIONS AT OTHER LOCATIONS AND TIMES.

DEPTH IN FEET	SAMPLE NO.	LITHOLOGY	GROUNDWATER	SOIL CLASS (USCS)	TRENCH T 49		PENETRATION RESISTANCE (BLOWS/FT.)	DRY DENSITY (P.C.F.)	MOISTURE CONTENT (%)		
					ELEV. (MSL.) <u>264'</u>	DATE COMPLETED <u>10-26-2017</u>					
					EQUIPMENT <u>CAT 330DL w/ 36-inch Bucket</u>		BY: <u>T. REIST</u>				
MATERIAL DESCRIPTION											
0				SM	UNDOCUMENTED FILL (Qudf) Medium dense, damp to moist, brown, Silty to Gravelly SAND with 10%-30% gravel and trace cobble size rock fragments up to 10-inches						
2											
4											
6											
8											
10					CL	Stiff, moist, dark brown to light brown, Sandy to Gravelly, CLAY with 10%-30% gravel and cobble size rock fragments up to 10-inches; moderate caving between 6-16 feet					
12											
14							-Trace boulders up to 20-inches present below 13 feet -Becomes wet below 14 feet				
16											
18						GM	-Probable contact at 18 feet; trench caved in after reaching contact				
						STADIUM CONGLOMERATE (Tst) Dense, damp, light brown, fine to coarse, Sandy CONGLOMERATE with 50%-60% gravel and cobble size rock fragments up to 10-inches					
						TRENCH TERMINATED AT 18.5 FEET DUE TO CAVING					

Figure A-49,
Log of Trench T 49, Page 1 of 1

G2070-42-02.GPJ

SAMPLE SYMBOLS	... SAMPLING UNSUCCESSFUL	... STANDARD PENETRATION TEST	... DRIVE SAMPLE (UNDISTURBED)
	... DISTURBED OR BAG SAMPLE	... CHUNK SAMPLE	... WATER TABLE OR SEEPAGE

NOTE: THE LOG OF SUBSURFACE CONDITIONS SHOWN HEREON APPLIES ONLY AT THE SPECIFIC BORING OR TRENCH LOCATION AND AT THE DATE INDICATED. IT IS NOT WARRANTED TO BE REPRESENTATIVE OF SUBSURFACE CONDITIONS AT OTHER LOCATIONS AND TIMES.







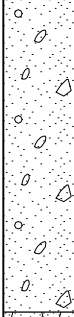

DEPTH IN FEET	SAMPLE NO.	LITHOLOGY	GROUNDWATER	SOIL CLASS (USCS)	TRENCH T 50		PENETRATION RESISTANCE (BLOWS/FT.)	DRY DENSITY (P.C.F.)	MOISTURE CONTENT (%)
					ELEV. (MSL.) <u>255'</u>	DATE COMPLETED <u>10-26-2017</u>			
					EQUIPMENT <u>CAT 330DL w/ 36-inch Bucket</u>		BY: <u>T. REIST</u>		
MATERIAL DESCRIPTION									
0				SM	COMPACTED FILL (Qcf) Medium dense, moist, Gravelly, fine to coarse SAND with 30%-40% gravel and cobble size rock fragments up to 10-inches				
2									
4									
6									
8				GM	STADIUM CONGLOMERATE (Tst) Dense, damp, orange brown, Sandy CONGLOMERATE with 50%-60% gravel, cobble, and boulder size rock fragments up to 14-inches				
TRENCH TERMINATED AT 9 FEET									

Figure A-50,
Log of Trench T 50, Page 1 of 1

G2070-42-02.GPJ

SAMPLE SYMBOLS	 ... SAMPLING UNSUCCESSFUL	 ... STANDARD PENETRATION TEST	 ... DRIVE SAMPLE (UNDISTURBED)
	 ... DISTURBED OR BAG SAMPLE	 ... CHUNK SAMPLE	 ... WATER TABLE OR SEEPAGE

NOTE: THE LOG OF SUBSURFACE CONDITIONS SHOWN HEREON APPLIES ONLY AT THE SPECIFIC BORING OR TRENCH LOCATION AND AT THE DATE INDICATED. IT IS NOT WARRANTED TO BE REPRESENTATIVE OF SUBSURFACE CONDITIONS AT OTHER LOCATIONS AND TIMES.

DEPTH IN FEET	SAMPLE NO.	LITHOLOGY	GROUNDWATER	SOIL CLASS (USCS)	TRENCH T 51		PENETRATION RESISTANCE (BLOWS/FT.)	DRY DENSITY (P.C.F.)	MOISTURE CONTENT (%)
					ELEV. (MSL.) <u>235'</u>	DATE COMPLETED <u>10-26-2017</u>			
					EQUIPMENT <u>CAT 330DL w/ 36-inch Bucket</u>		BY: <u>T. REIST</u>		
MATERIAL DESCRIPTION									
0				SM	COMPACTED FILL (Qcf) Medium dense, wet, brown, Gravelly, fine to coarse SAND with 30%-40% gravel and cobble size rock fragments up to 10-inches				
2									
4									
6				GM	STADIUM CONGLOMERATE (Tst) Dense, damp, orange brown, Sandy CONGLOMERATE with 50%-60% gravel, cobble, and boulder size rock fragments up to 14-inches				
TRENCH TERMINATED AT 7 FEET									

Figure A-51,
Log of Trench T 51, Page 1 of 1

G2070-42-02.GPJ

SAMPLE SYMBOLS		... SAMPLING UNSUCCESSFUL		... STANDARD PENETRATION TEST		... DRIVE SAMPLE (UNDISTURBED)
		... DISTURBED OR BAG SAMPLE		... CHUNK SAMPLE		... WATER TABLE OR SEEPAGE

NOTE: THE LOG OF SUBSURFACE CONDITIONS SHOWN HEREON APPLIES ONLY AT THE SPECIFIC BORING OR TRENCH LOCATION AND AT THE DATE INDICATED. IT IS NOT WARRANTED TO BE REPRESENTATIVE OF SUBSURFACE CONDITIONS AT OTHER LOCATIONS AND TIMES.

DEPTH IN FEET	SAMPLE NO.	LITHOLOGY	GROUNDWATER	SOIL CLASS (USCS)	TRENCH T 52		PENETRATION RESISTANCE (BLOWS/FT.)	DRY DENSITY (P.C.F.)	MOISTURE CONTENT (%)		
					ELEV. (MSL.) <u>270'</u>	DATE COMPLETED <u>10-26-2017</u>					
					EQUIPMENT <u>CAT 330DL w/ 36-inch Bucket</u>		BY: <u>T. REIST</u>				
MATERIAL DESCRIPTION											
0				SM	<p>UNDOCUMENTED FILL (Qudf) Medium dense, damp to moist, Gravelly, fine to coarse SAND with some clay and with 30%-40% gravel and cobble size rock fragments up to 10-inches</p>						
2											
4											
6											
8											
10											
12											
14											
16											
18											
20											
22						SM	<p>ALLUVIUM (Qal) Medium dense, wet, dark gray, Gravelly, fine to coarse SAND</p> <p>-Groundwater at 24 feet</p>				
24				▼							
TRENCH TERMINATED AT 25.5 FEET											

Figure A-52,
Log of Trench T 52, Page 1 of 1

G2070-42-02.GPJ

SAMPLE SYMBOLS	... SAMPLING UNSUCCESSFUL	... STANDARD PENETRATION TEST	... DRIVE SAMPLE (UNDISTURBED)
	... DISTURBED OR BAG SAMPLE	... CHUNK SAMPLE	... WATER TABLE OR SEEPAGE

NOTE: THE LOG OF SUBSURFACE CONDITIONS SHOWN HEREON APPLIES ONLY AT THE SPECIFIC BORING OR TRENCH LOCATION AND AT THE DATE INDICATED. IT IS NOT WARRANTED TO BE REPRESENTATIVE OF SUBSURFACE CONDITIONS AT OTHER LOCATIONS AND TIMES.

DEPTH IN FEET	SAMPLE NO.	LITHOLOGY	GROUNDWATER	SOIL CLASS (USCS)	TRENCH T 53			PENETRATION RESISTANCE (BLOWS/FT.)	DRY DENSITY (P.C.F.)	MOISTURE CONTENT (%)
					ELEV. (MSL.) <u>271'</u>	DATE COMPLETED <u>10-26-2017</u>	EQUIPMENT <u>CAT 330DL w/ 36-inch Bucket</u> BY: <u>T. REIST</u>			
MATERIAL DESCRIPTION										
0				SP	UNDOCUMENTED FILL (Qudf) Loose, dry, gray, fine to coarse SAND					
2			SM/SC		Medium dense, damp to moist, brown, Clayey/Gravelly SAND with 20%-30% gravel and cobble size rock fragments up to 10-inches; trace boulders up to 20-inches					
4										
6										
8										
10										
12										
14										
16										
18				CL	ALLUVIUM (Qal) Medium dense, moist to wet, black to dark gray, Sandy/Gravelly CLAY with 10%-20% gravel and cobble size rock fragments up to 10-inches					
20										
22			GM		STADIUM CONGLOMERATE (Tst) Dense, damp, orange brown, fine to coarse, Sandy CONGLOMERATE with 50%-60% gravel and cobble size rock fragments up to 12-inches					
					TRENCH TERMINATED AT 23 FEET					

Figure A-53,
Log of Trench T 53, Page 1 of 1

G2070-42-02.GPJ

SAMPLE SYMBOLS		... SAMPLING UNSUCCESSFUL		... STANDARD PENETRATION TEST		... DRIVE SAMPLE (UNDISTURBED)
		... DISTURBED OR BAG SAMPLE		... CHUNK SAMPLE		... WATER TABLE OR SEEPAGE

NOTE: THE LOG OF SUBSURFACE CONDITIONS SHOWN HEREON APPLIES ONLY AT THE SPECIFIC BORING OR TRENCH LOCATION AND AT THE DATE INDICATED. IT IS NOT WARRANTED TO BE REPRESENTATIVE OF SUBSURFACE CONDITIONS AT OTHER LOCATIONS AND TIMES.







DEPTH IN FEET	SAMPLE NO.	LITHOLOGY	GROUNDWATER	SOIL CLASS (USCS)	TRENCH T 54		PENETRATION RESISTANCE (BLOWS/FT.)	DRY DENSITY (P.C.F.)	MOISTURE CONTENT (%)
					ELEV. (MSL.) <u>274'</u>	DATE COMPLETED <u>10-26-2017</u>			
					EQUIPMENT <u>CAT 330DL w/ 36-inch Bucket</u>		BY: <u>T. REIST</u>		
MATERIAL DESCRIPTION									
0				GM	UNDOCUMENTED FILL (Qudf) Loose, dry, brown, Sandy GRAVEL with 60%-70% gravel size rock fragments up to 3-inches				
2									
4				SC	Medium dense, moist to wet, dark brown and light brown, Clayey SAND with 10%-20% gravel and cobble size rock fragments up to 10-inches				
6									
8				GM	Loose, damp, brown and gray, fine to medium, Sandy GRAVEL with 50%-60% gravel and cobble size rock fragments up to 8-inches; moderate caving				
10									
12									
14									
TRENCH TERMINATED AT 15 FEET DUE TO CAVING									

Figure A-54,
Log of Trench T 54, Page 1 of 1

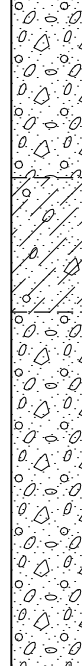
G2070-42-02.GPJ

SAMPLE SYMBOLS		... SAMPLING UNSUCCESSFUL		... STANDARD PENETRATION TEST		... DRIVE SAMPLE (UNDISTURBED)
		... DISTURBED OR BAG SAMPLE		... CHUNK SAMPLE		... WATER TABLE OR SEEPAGE

NOTE: THE LOG OF SUBSURFACE CONDITIONS SHOWN HEREON APPLIES ONLY AT THE SPECIFIC BORING OR TRENCH LOCATION AND AT THE DATE INDICATED. IT IS NOT WARRANTED TO BE REPRESENTATIVE OF SUBSURFACE CONDITIONS AT OTHER LOCATIONS AND TIMES.







DEPTH IN FEET	SAMPLE NO.	LITHOLOGY	GROUNDWATER	SOIL CLASS (USCS)	TRENCH T 55		PENETRATION RESISTANCE (BLOWS/FT.)	DRY DENSITY (P.C.F.)	MOISTURE CONTENT (%)
					ELEV. (MSL.) <u>289'</u>	DATE COMPLETED <u>10-26-2017</u>			
					EQUIPMENT <u>CAT 330DL w/ 36-inch Bucket</u>		BY: <u>T. REIST</u>		
MATERIAL DESCRIPTION									
0				SM	UNDOCUMENTED FILL (Qudf) Loose to medium dense, damp, brown, Gravelly, fine to medium SAND with 30%-40% gravel size rock fragments up to 2-inches				
2				SM	Medium dense, moist, brown, Silty, fine to medium SAND				
4				GM	Medium dense, moist, dark brown and brown, Clayey/Sandy GRAVEL with 40%-50% gravel size rock fragments up to 12-inches				
6				GM	STADIUM CONGLOMERATE (Tst) Dense, damp, orange brown, fine to coarse, Sandy CONGLOMERATE with 50%-60% gravel and cobble size rock fragments up to 10-inches				
8									
10									
12									
14									
16									
18									
					TRENCH TERMINATED AT 19 FEET				

Figure A-55,
Log of Trench T 55, Page 1 of 1

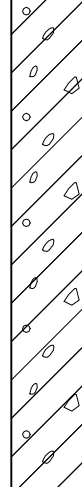
G2070-42-02.GPJ

SAMPLE SYMBOLS	 ... SAMPLING UNSUCCESSFUL	 ... STANDARD PENETRATION TEST	 ... DRIVE SAMPLE (UNDISTURBED)
	 ... DISTURBED OR BAG SAMPLE	 ... CHUNK SAMPLE	 ... WATER TABLE OR SEEPAGE

NOTE: THE LOG OF SUBSURFACE CONDITIONS SHOWN HEREON APPLIES ONLY AT THE SPECIFIC BORING OR TRENCH LOCATION AND AT THE DATE INDICATED. IT IS NOT WARRANTED TO BE REPRESENTATIVE OF SUBSURFACE CONDITIONS AT OTHER LOCATIONS AND TIMES.







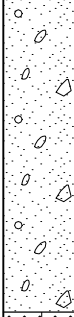

DEPTH IN FEET	SAMPLE NO.	LITHOLOGY	GROUNDWATER	SOIL CLASS (USCS)	TRENCH T 56		PENETRATION RESISTANCE (BLOWS/FT.)	DRY DENSITY (P.C.F.)	MOISTURE CONTENT (%)
					ELEV. (MSL.) <u>282'</u>	DATE COMPLETED <u>10-26-2017</u>			
					EQUIPMENT <u>CAT 330DL w/ 36-inch Bucket</u>		BY: <u>T. REIST</u>		
MATERIAL DESCRIPTION									
0				SM	UNDOCUMENTED FILL (Qudf) Medium dense, damp, brown, Gravelly, fine to medium SAND with 40%-50% gravel size rock fragments up to 1-inch				
2						-Gravel content decreases with depth			
4									
6									
8				SM	STADIUM CONGLOMERATE (Tst) Dense, damp, gray, Silty, fine to medium SANDSTONE				
TRENCH TERMINATED AT 9 FEET									

Figure A-56,
Log of Trench T 56, Page 1 of 1

G2070-42-02.GPJ

SAMPLE SYMBOLS		... SAMPLING UNSUCCESSFUL		... STANDARD PENETRATION TEST		... DRIVE SAMPLE (UNDISTURBED)
		... DISTURBED OR BAG SAMPLE		... CHUNK SAMPLE		... WATER TABLE OR SEEPAGE

NOTE: THE LOG OF SUBSURFACE CONDITIONS SHOWN HEREON APPLIES ONLY AT THE SPECIFIC BORING OR TRENCH LOCATION AND AT THE DATE INDICATED. IT IS NOT WARRANTED TO BE REPRESENTATIVE OF SUBSURFACE CONDITIONS AT OTHER LOCATIONS AND TIMES.

DEPTH IN FEET	SAMPLE NO.	LITHOLOGY	GROUNDWATER	SOIL CLASS (USCS)	TRENCH T 57		PENETRATION RESISTANCE (BLOWS/FT.)	DRY DENSITY (P.C.F.)	MOISTURE CONTENT (%)	
					ELEV. (MSL.) <u>276'</u>	DATE COMPLETED <u>10-26-2017</u>				
					EQUIPMENT <u>CAT 330DL w/ 36-inch Bucket</u>		BY: <u>T. REIST</u>			
MATERIAL DESCRIPTION										
0				SM/SC	UNDOCUMENTED FILL (Qudf) Loose, moist, brown and gray, Silty to Clayey, fine to medium SAND					
2										
4										
6				GM	Loose to medium dense, damp, gray and brown, Silty GRAVEL with 70%-90% gravel size rock fragments up to 2-inches					
8										
10						-Becomes loose, wet, brown, Clayey to Sandy, gravel with 50%-60% gravel and cobble size rock fragments up to 6-inches and minor caving below 10 feet				
12										
14										
16				GM	STADIUM CONGLOMERATE (Tst) Very dense, damp, light brown, fine to coarse, Sandy CONGLOMERATE with 50%-60% gravel and cobble size rock fragments up to 10-inches					
						TRENCH TERMINATED AT 16.5 FEET				

Figure A-57,
Log of Trench T 57, Page 1 of 1

G2070-42-02.GPJ

SAMPLE SYMBOLS		... SAMPLING UNSUCCESSFUL		... STANDARD PENETRATION TEST		... DRIVE SAMPLE (UNDISTURBED)
		... DISTURBED OR BAG SAMPLE		... CHUNK SAMPLE		... WATER TABLE OR SEEPAGE

NOTE: THE LOG OF SUBSURFACE CONDITIONS SHOWN HEREON APPLIES ONLY AT THE SPECIFIC BORING OR TRENCH LOCATION AND AT THE DATE INDICATED. IT IS NOT WARRANTED TO BE REPRESENTATIVE OF SUBSURFACE CONDITIONS AT OTHER LOCATIONS AND TIMES.







DEPTH IN FEET	SAMPLE NO.	LITHOLOGY	GROUNDWATER	SOIL CLASS (USCS)	TRENCH T 58		PENETRATION RESISTANCE (BLOWS/FT.)	DRY DENSITY (P.C.F.)	MOISTURE CONTENT (%)	
					ELEV. (MSL.) <u>281'</u>	DATE COMPLETED <u>10-26-2017</u>				
					EQUIPMENT <u>CAT 330DL w/ 36-inch Bucket</u>		BY: <u>T. REIST</u>			
MATERIAL DESCRIPTION										
0				SM&SC	UNDOCUMENTED FILL (Qudf) Loose to medium dense, moist to wet, brown to dark brown and gray, Silty to Clayey SAND					
2										
4										
6										
8										
10					CL/CH	Soft to stiff, wet brown, black and green, Silty CLAY with abundant organics				
12										
14										
16										
18										
20						-Becomes more plastic with depth				
22										
24										
TRENCH TERMINATED AT 25 FEET										

Figure A-58,
Log of Trench T 58, Page 1 of 1

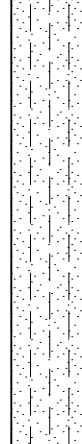
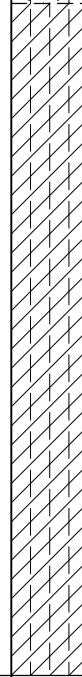
G2070-42-02.GPJ

SAMPLE SYMBOLS		... SAMPLING UNSUCCESSFUL		... STANDARD PENETRATION TEST		... DRIVE SAMPLE (UNDISTURBED)
		... DISTURBED OR BAG SAMPLE		... CHUNK SAMPLE		... WATER TABLE OR SEEPAGE

NOTE: THE LOG OF SUBSURFACE CONDITIONS SHOWN HEREON APPLIES ONLY AT THE SPECIFIC BORING OR TRENCH LOCATION AND AT THE DATE INDICATED. IT IS NOT WARRANTED TO BE REPRESENTATIVE OF SUBSURFACE CONDITIONS AT OTHER LOCATIONS AND TIMES.

DEPTH IN FEET	SAMPLE NO.	LITHOLOGY	GROUNDWATER	SOIL CLASS (USCS)	TRENCH T 59		PENETRATION RESISTANCE (BLOWS/FT.)	DRY DENSITY (P.C.F.)	MOISTURE CONTENT (%)
					ELEV. (MSL.) <u>276'</u>	DATE COMPLETED <u>10-27-2017</u>			
					EQUIPMENT <u>JD 350G w/ 48-inch Bucket</u>		BY: <u>T. REIST</u>		
MATERIAL DESCRIPTION									
0				SM	UNDOCUMENTED FILL (Qudf) Medium dense, damp, light brown, Silty, fine to medium SAND				
2									
4				SM	COMPACTED FILL (Qcf) Dense to very dense, damp, light brown, Silty, fine to medium SAND				
6						-Some gravel layers present below 6 feet			
8									
10									
12									
14						-Thin layers of concrete present below 13 feet			
16					PRACTICAL REFUSAL AT 16 FEET				

Figure A-59,
Log of Trench T 59, Page 1 of 1

G2070-42-02.GPJ

SAMPLE SYMBOLS	... SAMPLING UNSUCCESSFUL	... STANDARD PENETRATION TEST	... DRIVE SAMPLE (UNDISTURBED)
	... DISTURBED OR BAG SAMPLE	... CHUNK SAMPLE	... WATER TABLE OR SEEPAGE

NOTE: THE LOG OF SUBSURFACE CONDITIONS SHOWN HEREON APPLIES ONLY AT THE SPECIFIC BORING OR TRENCH LOCATION AND AT THE DATE INDICATED. IT IS NOT WARRANTED TO BE REPRESENTATIVE OF SUBSURFACE CONDITIONS AT OTHER LOCATIONS AND TIMES.







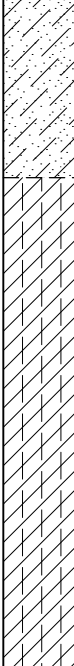

DEPTH IN FEET	SAMPLE NO.	LITHOLOGY	GROUNDWATER	SOIL CLASS (USCS)	TRENCH T 60		PENETRATION RESISTANCE (BLOWS/FT.)	DRY DENSITY (P.C.F.)	MOISTURE CONTENT (%)	
					ELEV. (MSL.) <u>285'</u>	DATE COMPLETED <u>10-27-2017</u>				
					EQUIPMENT <u>JD 350G w/ 48-inch Bucket</u>		BY: <u>T. REIST</u>			
MATERIAL DESCRIPTION										
0				SM/SC	UNDOCUMENTED FILL (Qudf) Loose, moist, grayish brown, Clayey/Silty, fine to medium SAND with some gravel					
2										
4					CL/CH	Stiff, wet, dark, brown, Silty CLAY				
6						-Becomes brown below 6 feet				
8										
10					-Becomes soft, brown, dark brown and black and more plastic with abundant organics below 10 feet					
12										
14										
16				SM	Loose to medium dense, wet, brown, Gravelly, fine to medium SAND with 30%-40% 1 to 2-inch gravel					
18										
20						-Entire sidewall caved in at 20 feet				
					TRENCH TERMINATED AT 20 FEET DUE TO CAVING					

Figure A-60,
Log of Trench T 60, Page 1 of 1

G2070-42-02.GPJ

SAMPLE SYMBOLS		... SAMPLING UNSUCCESSFUL		... STANDARD PENETRATION TEST		... DRIVE SAMPLE (UNDISTURBED)
		... DISTURBED OR BAG SAMPLE		... CHUNK SAMPLE		... WATER TABLE OR SEEPAGE

NOTE: THE LOG OF SUBSURFACE CONDITIONS SHOWN HEREON APPLIES ONLY AT THE SPECIFIC BORING OR TRENCH LOCATION AND AT THE DATE INDICATED. IT IS NOT WARRANTED TO BE REPRESENTATIVE OF SUBSURFACE CONDITIONS AT OTHER LOCATIONS AND TIMES.

DEPTH IN FEET	SAMPLE NO.	LITHOLOGY	GROUNDWATER	SOIL CLASS (USCS)	TRENCH T 61		PENETRATION RESISTANCE (BLOWS/FT.)	DRY DENSITY (P.C.F.)	MOISTURE CONTENT (%)
					ELEV. (MSL.) <u>280'</u>	DATE COMPLETED <u>10-27-2017</u>			
					EQUIPMENT <u>JD 350G w/ 48-inch Bucket</u>		BY: <u>T. REIST</u>		
MATERIAL DESCRIPTION									
0				SM&SC	UNDOCUMENTED FILL (Qudf) Loose, moist, brown, Silty to Clayey, fine to medium SAND with trace gravel and cobble; caving; trench widened out				
2									
4									
6				CL/CH	Very soft, wet, light brown and gray, Silty CLAY				
8									
10						-Becomes black and plastic with heavy organics below 10 feet			
12									
14				SM	Medium dense, wet, brown, Gravelly, fine to medium SAND with 30%-40% 1 to 2-inch gravel				
16									
18									
20					-Entire sidewall caved in at 20 feet				
					TRENCH TERMINATED AT 20 FEET DUE TO CAVING				

Figure A-61,
Log of Trench T 61, Page 1 of 1

G2070-42-02.GPJ

SAMPLE SYMBOLS		... SAMPLING UNSUCCESSFUL		... STANDARD PENETRATION TEST		... DRIVE SAMPLE (UNDISTURBED)
		... DISTURBED OR BAG SAMPLE		... CHUNK SAMPLE		... WATER TABLE OR SEEPAGE

NOTE: THE LOG OF SUBSURFACE CONDITIONS SHOWN HEREON APPLIES ONLY AT THE SPECIFIC BORING OR TRENCH LOCATION AND AT THE DATE INDICATED. IT IS NOT WARRANTED TO BE REPRESENTATIVE OF SUBSURFACE CONDITIONS AT OTHER LOCATIONS AND TIMES.

DEPTH IN FEET	SAMPLE NO.	LITHOLOGY	GROUNDWATER	SOIL CLASS (USCS)	TRENCH T 62		PENETRATION RESISTANCE (BLOWS/FT.)	DRY DENSITY (P.C.F.)	MOISTURE CONTENT (%)
					ELEV. (MSL.) 282'	DATE COMPLETED 10-27-2017			
					EQUIPMENT JD 350G w/ 36-inch Bucket		BY: T. REIST		
MATERIAL DESCRIPTION									
0				SM	UNDOCUMENTED FILL (Qudf) Loose to medium dense, dry, gray, Gravelly, fine to coarse SAND with 10%-30% 1 to 3-inch gravel				
2				SM	Loose to medium dense, damp to moist, brown, Silty, fine to medium SAND with 10% gravel and some clay				
4				SM	COMPACTED FILL (Qcf) Medium dense, moist, brown, Silty, fine to medium SAND with some random gravel and cobble lenses				
6									
8									
10									
12				SM	ALLUVIUM (Qal) Loose, damp, brown, Silty, fine to medium SAND with 10%-20% gravel and cobble size rock fragments up to 8-inches				
14									
16									
18									
20				SM	STADIUM CONGLOMERATE (Tst) Dense, damp, gray, Gravelly, fine to medium SANDSTONE with 20%-30% gravel and cobble size rock fragments up to 10-inches				
22									
24									
					TRENCH TERMINATED AT 25 FEET				

Figure A-62,
Log of Trench T 62, Page 1 of 1

G2070-42-02.GPJ

SAMPLE SYMBOLS		... SAMPLING UNSUCCESSFUL		... STANDARD PENETRATION TEST		... DRIVE SAMPLE (UNDISTURBED)
		... DISTURBED OR BAG SAMPLE		... CHUNK SAMPLE		... WATER TABLE OR SEEPAGE

NOTE: THE LOG OF SUBSURFACE CONDITIONS SHOWN HEREON APPLIES ONLY AT THE SPECIFIC BORING OR TRENCH LOCATION AND AT THE DATE INDICATED. IT IS NOT WARRANTED TO BE REPRESENTATIVE OF SUBSURFACE CONDITIONS AT OTHER LOCATIONS AND TIMES.







DEPTH IN FEET	SAMPLE NO.	LITHOLOGY	GROUNDWATER	SOIL CLASS (USCS)	<p align="center">TRENCH T 63</p> <p>ELEV. (MSL.) <u>265'</u> DATE COMPLETED <u>10-27-2017</u></p> <p>EQUIPMENT <u>JD 350G w/ 36-inch Bucket</u> BY: <u>T. REIST</u></p>	PENETRATION RESISTANCE (BLOWS/FT.)	DRY DENSITY (P.C.F.)	MOISTURE CONTENT (%)
0 2 4				GM/GC	<p align="center">MATERIAL DESCRIPTION</p> <p>UNDOCUMENTED FILL (Qudf) Loose to medium dense, damp to dry, gray and brown, Sandy/Clayey GRAVEL with 50%-60% gravel size rock fragments up to 2-inches</p> <p>-Miscellaneous debris (pipe, cable) at 3 feet</p> <p>-4-inch metal pipe encountered at 5 feet; possible water line</p> <p align="center">TRENCH TERMINATED AT 5 FEET DUE TO PIPE</p>			

Figure A-63,
Log of Trench T 63, Page 1 of 1

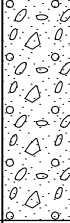
G2070-42-02.GPJ

<p>SAMPLE SYMBOLS</p> <p> ... SAMPLING UNSUCCESSFUL</p> <p> ... DISTURBED OR BAG SAMPLE</p>	<p> ... STANDARD PENETRATION TEST</p> <p> ... CHUNK SAMPLE</p>	<p> ... DRIVE SAMPLE (UNDISTURBED)</p> <p> ... WATER TABLE OR SEEPAGE</p>
--	--	---

NOTE: THE LOG OF SUBSURFACE CONDITIONS SHOWN HEREON APPLIES ONLY AT THE SPECIFIC BORING OR TRENCH LOCATION AND AT THE DATE INDICATED. IT IS NOT WARRANTED TO BE REPRESENTATIVE OF SUBSURFACE CONDITIONS AT OTHER LOCATIONS AND TIMES.







DEPTH IN FEET	SAMPLE NO.	LITHOLOGY	GROUNDWATER	SOIL CLASS (USCS)	TRENCH T 64		PENETRATION RESISTANCE (BLOWS/FT.)	DRY DENSITY (P.C.F.)	MOISTURE CONTENT (%)
					ELEV. (MSL.) <u>267'</u>	DATE COMPLETED <u>10-27-2017</u>			
					EQUIPMENT <u>JD 350G w/ 36-inch Bucket</u>		BY: <u>T. REIST</u>		
MATERIAL DESCRIPTION									
0				GM	UNDOCUMENTED FILL (Qudf) Loose, dry, gray, Sandy GRAVEL with 50%-70% gravel size rock fragments up to 7-inches -Becomes clayey below 2 feet				
2				GM	ALLUVIUM (Qal) Loose, damp, dark reddish brown, fine to coarse, Sandy GRAVEL with 50%-60% gravel and cobble size rock fragments up to 20-inches; minor caving				
4				GM	STADIUM CONGLOMERATE (Tst) Dense, damp, light brown to orange brown, fine to coarse Sandy CONGLOMERATE with 50%-60% gravel and cobble size rock fragments up to 10-inches				
6									
8									
10					TRENCH TERMINATED AT 10 FEET				

Figure A-64,
Log of Trench T 64, Page 1 of 1

G2070-42-02.GPJ

SAMPLE SYMBOLS	 ... SAMPLING UNSUCCESSFUL	 ... STANDARD PENETRATION TEST	 ... DRIVE SAMPLE (UNDISTURBED)
	 ... DISTURBED OR BAG SAMPLE	 ... CHUNK SAMPLE	 ... WATER TABLE OR SEEPAGE

NOTE: THE LOG OF SUBSURFACE CONDITIONS SHOWN HEREON APPLIES ONLY AT THE SPECIFIC BORING OR TRENCH LOCATION AND AT THE DATE INDICATED. IT IS NOT WARRANTED TO BE REPRESENTATIVE OF SUBSURFACE CONDITIONS AT OTHER LOCATIONS AND TIMES.







DEPTH IN FEET	SAMPLE NO.	LITHOLOGY	GROUNDWATER	SOIL CLASS (USCS)	TRENCH T 65		PENETRATION RESISTANCE (BLOWS/FT.)	DRY DENSITY (P.C.F.)	MOISTURE CONTENT (%)
					ELEV. (MSL.) <u>266'</u>	DATE COMPLETED <u>10-27-2017</u>			
					EQUIPMENT <u>JD 350G w/ 36-inch Bucket</u> BY: <u>T. REIST</u>				
					MATERIAL DESCRIPTION				
0				GM	UNDOCUMENTED FILL (Qudf) Loose to medium dense, damp, grayish brown, fine to coarse, Sandy GRAVEL with 50%-60% gravel size rock fragments up to 1-inch -Refusal on suspected abandoned concrete tunnel				
2						REFUSAL AT 2.5 FEET			

Figure A-65,
Log of Trench T 65, Page 1 of 1

G2070-42-02.GPJ

SAMPLE SYMBOLS	 ... SAMPLING UNSUCCESSFUL	 ... STANDARD PENETRATION TEST	 ... DRIVE SAMPLE (UNDISTURBED)
	 ... DISTURBED OR BAG SAMPLE	 ... CHUNK SAMPLE	 ... WATER TABLE OR SEEPAGE

NOTE: THE LOG OF SUBSURFACE CONDITIONS SHOWN HEREON APPLIES ONLY AT THE SPECIFIC BORING OR TRENCH LOCATION AND AT THE DATE INDICATED. IT IS NOT WARRANTED TO BE REPRESENTATIVE OF SUBSURFACE CONDITIONS AT OTHER LOCATIONS AND TIMES.

DEPTH IN FEET	SAMPLE NO.	LITHOLOGY	GROUNDWATER	SOIL CLASS (USCS)	TRENCH T 66		PENETRATION RESISTANCE (BLOWS/FT.)	DRY DENSITY (P.C.F.)	MOISTURE CONTENT (%)
					ELEV. (MSL.) <u>261'</u>	DATE COMPLETED <u>10-27-2017</u>			
					EQUIPMENT <u>JD 350G w/ 36-inch Bucket</u>		BY: <u>T. REIST</u>		
MATERIAL DESCRIPTION									
0				GM	UNDOCUMENTED FILL (Qudf) Loose, dry, gray, 3/4-inch GRAVEL				
2			GM	ALLUVIUM (Qal) Loose, damp to dry, dark reddish brown, fine to coarse, Sandy GRAVEL with 50%-70% gravel and cobble size rock fragments up to 20-inches					
4					-Minor caving				
6									
8									
10				GM	STADIUM CONGLOMERATE (Tst) Dense, damp, light brown, fine to coarse, Sandy CONGLOMERATE with 50%-60% gravel and cobble size rock fragments up to 10-inches				
					TRENCH TERMINATED AT 10 FEET				

Figure A-66,
Log of Trench T 66, Page 1 of 1

G2070-42-02.GPJ

SAMPLE SYMBOLS	... SAMPLING UNSUCCESSFUL	... STANDARD PENETRATION TEST	... DRIVE SAMPLE (UNDISTURBED)
	... DISTURBED OR BAG SAMPLE	... CHUNK SAMPLE	... WATER TABLE OR SEEPAGE

NOTE: THE LOG OF SUBSURFACE CONDITIONS SHOWN HEREON APPLIES ONLY AT THE SPECIFIC BORING OR TRENCH LOCATION AND AT THE DATE INDICATED. IT IS NOT WARRANTED TO BE REPRESENTATIVE OF SUBSURFACE CONDITIONS AT OTHER LOCATIONS AND TIMES.

DEPTH IN FEET	SAMPLE NO.	LITHOLOGY	GROUNDWATER	SOIL CLASS (USCS)	TRENCH T 67		PENETRATION RESISTANCE (BLOWS/FT.)	DRY DENSITY (P.C.F.)	MOISTURE CONTENT (%)
					ELEV. (MSL.) 267'	DATE COMPLETED 10-27-2017			
					EQUIPMENT JD 350G w/ 36-inch Bucket		BY: T. REIST		
MATERIAL DESCRIPTION									
0				SM/SC	UNDOCUMENTED FILL (Qudf) Loose to medium dense, moist, brown, Silty/Clayey, fine to medium SAND with trace gravel and cobble				
2									
4									
6									
8									
10				SM	STADIUM CONGLOMERATE (Tst) Very dense, damp, gray and orange, Gravelly, fine to medium SANDSTONE with 30%-40% gravel and cobble size rock fragments up to 10-inches				
					TRENCH TERMINATED AT 11 FEET				

Figure A-67,
Log of Trench T 67, Page 1 of 1

G2070-42-02.GPJ







SAMPLE SYMBOLS		... SAMPLING UNSUCCESSFUL		... STANDARD PENETRATION TEST		... DRIVE SAMPLE (UNDISTURBED)
		... DISTURBED OR BAG SAMPLE		... CHUNK SAMPLE		... WATER TABLE OR SEEPAGE

NOTE: THE LOG OF SUBSURFACE CONDITIONS SHOWN HEREON APPLIES ONLY AT THE SPECIFIC BORING OR TRENCH LOCATION AND AT THE DATE INDICATED. IT IS NOT WARRANTED TO BE REPRESENTATIVE OF SUBSURFACE CONDITIONS AT OTHER LOCATIONS AND TIMES.

DEPTH IN FEET	SAMPLE NO.	LITHOLOGY	GROUNDWATER	SOIL CLASS (USCS)	TRENCH T 68		PENETRATION RESISTANCE (BLOWS/FT.)	DRY DENSITY (P.C.F.)	MOISTURE CONTENT (%)
					ELEV. (MSL.) 268	DATE COMPLETED 10-27-2017			
					EQUIPMENT JD 350G w/ 36-inch Bucket		BY: T. REIST		
MATERIAL DESCRIPTION									
0				SM	UNDOCUMENTED FILL (Qudf) Loose, moist, brown, Silty/Clayey, fine to medium SAND with some gravel				
2				SM	COMPACTED FILL (Qcf) Medium dense, moist, brown, Silty/Clayey, fine to medium SAND with some gravel				
4					-Random gravel and cobble size rock fragments up to 10-inches present below 5 feet				
6									
8									
10									
12									
14									
16									
18									
20									
22					-Some darker brown material present at 22 feet; possible alluvial contact				
24					-Entire sidewall collapsed at 24 feet				
					TRENCH TERMINATED AT 24 FEET DUE TO CAVING				

Figure A-68,
Log of Trench T 68, Page 1 of 1

G2070-42-02.GPJ

SAMPLE SYMBOLS	 ... SAMPLING UNSUCCESSFUL	 ... STANDARD PENETRATION TEST	 ... DRIVE SAMPLE (UNDISTURBED)
	 ... DISTURBED OR BAG SAMPLE	 ... CHUNK SAMPLE	 ... WATER TABLE OR SEEPAGE

NOTE: THE LOG OF SUBSURFACE CONDITIONS SHOWN HEREON APPLIES ONLY AT THE SPECIFIC BORING OR TRENCH LOCATION AND AT THE DATE INDICATED. IT IS NOT WARRANTED TO BE REPRESENTATIVE OF SUBSURFACE CONDITIONS AT OTHER LOCATIONS AND TIMES.

DEPTH IN FEET	SAMPLE NO.	LITHOLOGY	GROUNDWATER	SOIL CLASS (USCS)	TRENCH T 69		PENETRATION RESISTANCE (BLOWS/FT.)	DRY DENSITY (P.C.F.)	MOISTURE CONTENT (%)
					ELEV. (MSL.) <u>249'</u>	DATE COMPLETED <u>10-27-2017</u>			
					EQUIPMENT <u>JD 350G w/ 36-inch Bucket</u>		BY: <u>T. REIST</u>		
MATERIAL DESCRIPTION									
0				GM	UNDOCUMENTED FILL (Qudf) Loose, dry, gray, 3/4-inch GRAVEL				
2				SM	COMPACTED FILL (Qcf) Medium dense, moist, brown, Silty/Gravelly, fine to medium SAND with 20%-40% gravel and trace cobble				
4									
6									
8									
10									
12									
14									
16									
18				GM/GC	Medium dense, moist to wet, dark gray, Sandy/Clayey, GRAVEL with 50% gravel and cobble size rock fragments up to 10-inches and some organics				
20									
22									
24									
TRENCH TERMINATED AT 24 FEET									

Figure A-69,
Log of Trench T 69, Page 1 of 1

G2070-42-02.GPJ

SAMPLE SYMBOLS		... SAMPLING UNSUCCESSFUL		... STANDARD PENETRATION TEST		... DRIVE SAMPLE (UNDISTURBED)
		... DISTURBED OR BAG SAMPLE		... CHUNK SAMPLE		... WATER TABLE OR SEEPAGE

NOTE: THE LOG OF SUBSURFACE CONDITIONS SHOWN HEREON APPLIES ONLY AT THE SPECIFIC BORING OR TRENCH LOCATION AND AT THE DATE INDICATED. IT IS NOT WARRANTED TO BE REPRESENTATIVE OF SUBSURFACE CONDITIONS AT OTHER LOCATIONS AND TIMES.

DEPTH IN FEET	SAMPLE NO.	LITHOLOGY	GROUNDWATER	SOIL CLASS (USCS)	BORING LB 1		PENETRATION RESISTANCE (BLOWS/FT.)	DRY DENSITY (P.C.F.)	MOISTURE CONTENT (%)
					ELEV. (MSL.) <u>326'</u>	DATE COMPLETED <u>06-26-2017</u>			
					EQUIPMENT <u>BUCKET RIG</u>		BY: <u>BORJA/REIST</u>		
MATERIAL DESCRIPTION									
0				ML	UNDOCUMENTED FILL (Qudf) Firm to stiff, damp, olive brown to light brown, Sandy SILT; ~10% gravel and cobble				
2									
4									
6	LB1-1				-Becomes very stiff and moist below 5 ft.		1		
8				SM	COMPACTED FILL (Qcf) Medium dense, moist, light brown, Silty, fine to medium SAND; 10-20% gravel and cobble; majority of rock 3"-6" diameter with trace boulders -24" concretion observed at 7 ft.				
10	LB1-2				-Gravel and cobble content increase to ~20% below 10 ft.		3		
12									
14									
16	LB1-3				-Increases in moisture content; excavates with some 3/4" gravel and trace cobble		4		
18				SM&SC	Medium dense, moist, brown to olive brown, Silty to Clayey, fine to medium SAND; some gravel 3/4" size; few ±6" cobble				
20	LB1-4				-Observed 6" thick dark brown, Clayey SAND lens at 21 feet		3	124.9	9.5
22									
24									
26	LB1-5				-Becomes saturated below 24.5 ft.; constant seepage		4		
28					STADIUM CONGLOMERATE (Tst) Very dense, moist, mottled brown, olive brown and reddish brown, fine to medium, Sandy CONGLOMERATE -Standing water at 27.5 ft.				

Figure A-70,
Log of Boring LB 1, Page 1 of 2

G2070-42-02.GPJ







SAMPLE SYMBOLS		... SAMPLING UNSUCCESSFUL		... STANDARD PENETRATION TEST		... DRIVE SAMPLE (UNDISTURBED)
		... DISTURBED OR BAG SAMPLE		... CHUNK SAMPLE		... WATER TABLE OR SEEPAGE

NOTE: THE LOG OF SUBSURFACE CONDITIONS SHOWN HEREON APPLIES ONLY AT THE SPECIFIC BORING OR TRENCH LOCATION AND AT THE DATE INDICATED. IT IS NOT WARRANTED TO BE REPRESENTATIVE OF SUBSURFACE CONDITIONS AT OTHER LOCATIONS AND TIMES.

DEPTH IN FEET	SAMPLE NO.	LITHOLOGY	GROUNDWATER	SOIL CLASS (USCS)	BORING LB 2		PENETRATION RESISTANCE (BLOWS/FT.)	DRY DENSITY (P.C.F.)	MOISTURE CONTENT (%)
					ELEV. (MSL.) <u>319'</u>	DATE COMPLETED <u>06-26-2017</u>			
					EQUIPMENT <u>BUCKET RIG</u>		BY: <u>BORJA/REIST</u>		
MATERIAL DESCRIPTION									
0				GM	UNDOCUMENTED FILL (Qudf) Medium dense, dry to damp, olive brown, Sandy GRAVEL; majority of rock 3/4"-1"				
2				SM	Medium dense, moist, olive brown, Silty, fine to medium SAND; 10-20% grave and cobble				
4									
6	LB2-1				-Becomes loose with ~20%-30% gravel ± 1" size and 10-15% cobble 8" to 10" size from 6 to 8 feet		4		
8					-Geotechnically logged to 8 ft. due to loose caving conditions				
10	LB2-2						4		
12				SM	COMPACTED FILL (Qcf) Medium dense, moist, brown to light brown, Silty, fine to medium SAND; ~20%-30% gravel and cobble				
14									
16	LB2-3						5	91.2	9.2
18									
20	LB2-4				-Increase in cobble content; ±12" size		5	108.1	14.7
22									
24									
26	LB2-5				-Becomes dark brown		3		8.9
28									

Figure A-71,
Log of Boring LB 2, Page 1 of 2

G2070-42-02.GPJ

SAMPLE SYMBOLS	 ... SAMPLING UNSUCCESSFUL	 ... STANDARD PENETRATION TEST	 ... DRIVE SAMPLE (UNDISTURBED)
	 ... DISTURBED OR BAG SAMPLE	 ... CHUNK SAMPLE	 ... WATER TABLE OR SEEPAGE

NOTE: THE LOG OF SUBSURFACE CONDITIONS SHOWN HEREON APPLIES ONLY AT THE SPECIFIC BORING OR TRENCH LOCATION AND AT THE DATE INDICATED. IT IS NOT WARRANTED TO BE REPRESENTATIVE OF SUBSURFACE CONDITIONS AT OTHER LOCATIONS AND TIMES.







DEPTH IN FEET	SAMPLE NO.	LITHOLOGY	GROUNDWATER	SOIL CLASS (USCS)	BORING LB 2		PENETRATION RESISTANCE (BLOWS/FT.)	DRY DENSITY (P.C.F.)	MOISTURE CONTENT (%)
					ELEV. (MSL.) <u>319'</u>	DATE COMPLETED <u>06-26-2017</u>			
					EQUIPMENT <u>BUCKET RIG</u> BY: <u>BORJA/REIST</u>				
					MATERIAL DESCRIPTION				
30	LB2-6						3	112.4	10.6
32									
34				SM&SC	ALLUVIUM (Qal) Medium dense, moist, to wet, mottled brown and grayish brown, Silty to Clayey, fine to coarse SAND; ~20%-30% gravel and cobble; ±6"-10" size				
36									
38									
40									
42			▼	GM	STADIUM CONGLOMERATE (Tst) Very dense, wet to saturated, yellowish brown to brown, fine to coarse, Sandy CONGLOMERATE -Seepage at 42 feet				
44	LB2-7				BORING TERMINATED AT 44 FEET				
					BORING TERMINATED AT 44 FEET				

Figure A-71,
Log of Boring LB 2, Page 2 of 2

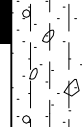
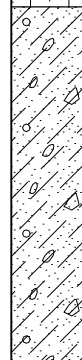
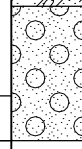
G2070-42-02.GPJ

SAMPLE SYMBOLS		... SAMPLING UNSUCCESSFUL		... STANDARD PENETRATION TEST		... DRIVE SAMPLE (UNDISTURBED)
		... DISTURBED OR BAG SAMPLE		... CHUNK SAMPLE		... WATER TABLE OR SEEPAGE

NOTE: THE LOG OF SUBSURFACE CONDITIONS SHOWN HEREON APPLIES ONLY AT THE SPECIFIC BORING OR TRENCH LOCATION AND AT THE DATE INDICATED. IT IS NOT WARRANTED TO BE REPRESENTATIVE OF SUBSURFACE CONDITIONS AT OTHER LOCATIONS AND TIMES.

DEPTH IN FEET	SAMPLE NO.	LITHOLOGY	GROUNDWATER	SOIL CLASS (USCS)	BORING LB 3		PENETRATION RESISTANCE (BLOWS/FT.)	DRY DENSITY (P.C.F.)	MOISTURE CONTENT (%)	
					ELEV. (MSL.) 304'	DATE COMPLETED 06-26-2017				
					EQUIPMENT BUCKET RIG		BY: BORJA/REIST			
MATERIAL DESCRIPTION										
0				GM	<p>UNDOCUMENTED FILL (Qudf) Medium dense, dry to damp, light brown to brown, Sandy GRAVEL; ~±2" size gravel -Becomes moist and tan to brown with few cobble below 2 feet</p>					
2										
4				CL	<p>COMPACTED FILL (Qcf) Medium dense, moist to very moist, Gravelly CLAY with 20%-30% gravel up to 1"</p>					
6										
8				SC	<p>Medium dense, moist to very moist, Clayey, fine to coarse SAND; ~10%-15% gravel -Excavates with ~20% cobble ±6" size below 11 feet -Excavates with 5% cobble ±10" size below 12 feet</p>					
10										
12										
14										
16				SM	<p>Medium dense, moist, brown, Silty, fine to medium SAND; ~10%-20% gravel and cobble; ±8" size -Increase in moisture contact; decrease in cobble and boulder content with low cohesion between 16-19 ft.</p>					
18										
20										
22										
24										
26										
28										

Figure A-72,
Log of Boring LB 3, Page 1 of 2

G2070-42-02.GPJ

SAMPLE SYMBOLS		... SAMPLING UNSUCCESSFUL		... STANDARD PENETRATION TEST		... DRIVE SAMPLE (UNDISTURBED)
		... DISTURBED OR BAG SAMPLE		... CHUNK SAMPLE		... WATER TABLE OR SEEPAGE

NOTE: THE LOG OF SUBSURFACE CONDITIONS SHOWN HEREON APPLIES ONLY AT THE SPECIFIC BORING OR TRENCH LOCATION AND AT THE DATE INDICATED. IT IS NOT WARRANTED TO BE REPRESENTATIVE OF SUBSURFACE CONDITIONS AT OTHER LOCATIONS AND TIMES.













DEPTH IN FEET	SAMPLE NO.	LITHOLOGY	GROUNDWATER	SOIL CLASS (USCS)	BORING LB 3		PENETRATION RESISTANCE (BLOWS/FT.)	DRY DENSITY (P.C.F.)	MOISTURE CONTENT (%)
					ELEV. (MSL.) 304'	DATE COMPLETED 06-26-2017			
					EQUIPMENT BUCKET RIG		BY: BORJA/REIST		
MATERIAL DESCRIPTION									
30				SC	Medium dense, moist to very moist, gray to grayish brown, Clayey, fine to coarse SAND; ~20% gravel and cobble; ±6" size				
32				SM	-Slight seepage at 30.5 ft. STADIUM CONGLOMERATE (Tst)				
34				GM	Dense, moist, mottled light brown and light green, Silty, fine to medium-grained SANDSTONE				
36				GM	Very dense, wet, yellowish brown to brown, fine to coarse, Sandy CONGLOMERATE				
38									
40					BORING TERMINATED AT 40 FEET				

Figure A-72,
Log of Boring LB 3, Page 2 of 2

G2070-42-02.GPJ







SAMPLE SYMBOLS	 ... SAMPLING UNSUCCESSFUL	 ... STANDARD PENETRATION TEST	 ... DRIVE SAMPLE (UNDISTURBED)
	 ... DISTURBED OR BAG SAMPLE	 ... CHUNK SAMPLE	 ... WATER TABLE OR SEEPAGE

NOTE: THE LOG OF SUBSURFACE CONDITIONS SHOWN HEREON APPLIES ONLY AT THE SPECIFIC BORING OR TRENCH LOCATION AND AT THE DATE INDICATED. IT IS NOT WARRANTED TO BE REPRESENTATIVE OF SUBSURFACE CONDITIONS AT OTHER LOCATIONS AND TIMES.

DEPTH IN FEET	SAMPLE NO.	LITHOLOGY	GROUNDWATER	SOIL CLASS (USCS)	BORING LB 4		PENETRATION RESISTANCE (BLOWS/FT.)	DRY DENSITY (P.C.F.)	MOISTURE CONTENT (%)
					ELEV. (MSL.) 283'	DATE COMPLETED 06-28-2017			
					EQUIPMENT BUCKET RIG		BY: BORJA/REIST		
MATERIAL DESCRIPTION									
0				SM	UNDOCUMENTED FILL (Qudf) Medium dense, damp to moist, brown, Silty, fine to medium SAND; ~10%-15% gravel and cobble, ±4" size rock				
2					-Becomes moist with a few cobbles ±6" size below 3 feet				
4									
6				SC	Medium dense, moist, brown, Clayey, fine to medium SAND; ~20%-30% gravel and cobble ±6" size				
8					-Becomes fine to coarse and dark brown at 8 ft.				
10				SP	Medium dense, moist, light grayish brown, fine to coarse SAND; some silt; 10% gravel and cobble; trace asphalt chunks				
12				SM	Medium dense, moist, dark brown, Silty, fine to coarse SAND; few gravel and cobble; ±6"; trace asphalt chunks				
14				SC	Medium dense, moist, light brown, Clayey, fine to coarse SAND; ~10%-20% gravel and cobble; ±8" size				
16									
18				CL	Firm to stiff, moist, light gray to grayish brown and dark gray, Sandy CLAY; ~10%-20% gravel and cobble; ±6" in size				
20	LB4-1						3		
22				GM	STADIUM CONGLOMERATE (Tst) Dense to very dense, damp, brown to yellowish brown, fine to coarse, Sandy CONGLOMERATE				
24									
26	LB4-2						8/5"		
BORING TERMINATED AT 26 FEET									

Figure A-73,
Log of Boring LB 4, Page 1 of 1

G2070-42-02.GPJ







SAMPLE SYMBOLS	 ... SAMPLING UNSUCCESSFUL	 ... STANDARD PENETRATION TEST	 ... DRIVE SAMPLE (UNDISTURBED)
	 ... DISTURBED OR BAG SAMPLE	 ... CHUNK SAMPLE	 ... WATER TABLE OR SEEPAGE

NOTE: THE LOG OF SUBSURFACE CONDITIONS SHOWN HEREON APPLIES ONLY AT THE SPECIFIC BORING OR TRENCH LOCATION AND AT THE DATE INDICATED. IT IS NOT WARRANTED TO BE REPRESENTATIVE OF SUBSURFACE CONDITIONS AT OTHER LOCATIONS AND TIMES.

DEPTH IN FEET	SAMPLE NO.	LITHOLOGY	GROUNDWATER	SOIL CLASS (USCS)	BORING LB 5		PENETRATION RESISTANCE (BLOWS/FT.)	DRY DENSITY (P.C.F.)	MOISTURE CONTENT (%)
					ELEV. (MSL.) 269'	DATE COMPLETED 06-27-2017			
					EQUIPMENT BUCKET RIG		BY: BORJA/REIST		
MATERIAL DESCRIPTION									
0				GM	UNDOCUMENTED FILL (Qudf) Loose to medium dense, dry, light gray to light brown, Sandy GRAVEL; ~70%-80% ±2" gravel; clast supported				
2									
4					-Geotechnically logged to 4 feet due to unsafe conditions				
6									
8				CL	Stiff, moist to wet, dark brown to dark brown, Sandy CLAY; ~10%-20% gravel and cobble ±6" in size				
10					-Trace asphalt concrete present at 10 feet				
12				SM&SC	Medium dense, moist, brown, Silty to Clayey, fine to medium SAND; 10%-20% gravel and cobble ±6" size				
14				SM	Medium dense, moist, grayish brown to gray, Silty, fine to coarse SAND; ~10%-20% gravel and cobble ±6" size				
16	LB5-1			CL	ALLUVIUM (Qal) Stiff, moist, dark gray, Sandy CLAY; ~10% gravel and cobble ±6" size		5		
18				GM	STADIUM CONGLOMERATE (Tst) Dense, moist, brown to grayish brown, fine to coarse, Sandy CONGLOMERATE				
20	LB5-2						8		
BORING TERMINATED AT 21 FEET									

Figure A-74,
Log of Boring LB 5, Page 1 of 1

G2070-42-02.GPJ

SAMPLE SYMBOLS	 ... SAMPLING UNSUCCESSFUL	 ... STANDARD PENETRATION TEST	 ... DRIVE SAMPLE (UNDISTURBED)
	 ... DISTURBED OR BAG SAMPLE	 ... CHUNK SAMPLE	 ... WATER TABLE OR SEEPAGE

NOTE: THE LOG OF SUBSURFACE CONDITIONS SHOWN HEREON APPLIES ONLY AT THE SPECIFIC BORING OR TRENCH LOCATION AND AT THE DATE INDICATED. IT IS NOT WARRANTED TO BE REPRESENTATIVE OF SUBSURFACE CONDITIONS AT OTHER LOCATIONS AND TIMES.

DEPTH IN FEET	SAMPLE NO.	LITHOLOGY	GROUNDWATER	SOIL CLASS (USCS)	BORING LB 6		PENETRATION RESISTANCE (BLOWS/FT.)	DRY DENSITY (P.C.F.)	MOISTURE CONTENT (%)	
					ELEV. (MSL.) 268'	DATE COMPLETED 06-28-2017				
					EQUIPMENT BUCKET RIG		BY: BORJA/REIST			
MATERIAL DESCRIPTION										
0				SM	UNDOCUMENTED FILL (Qudf) Loose to medium dense, dry to damp, light brown, Silty, fine to medium SAND; 20% gravel and cobble ±6" size rock					
2										
4										
6										
8										
10										
12										
14										
16					SC	ALLUVIUM (Qal) Medium dense, moist, dark greenish gray to black, Clayey, fine to coarse SAND; 10%-20% gravel and cobble ±4" size rock				
18					CL	Medium dense, moist, dark gray to black, Sandy CLAY; 10% gravel and cobble				
20										
22					SP	Medium dense, moist, dark gray to black, fine to coarse SAND; little silt; some gravel; trace cobble				
24					ML	Firm, wet to saturated, mottled yellowish brown, greenish gray and tan, Sandy to Clayey SILT; seepage at 23 feet				
26					GM	STADIUM CONGLOMERATE (Tst) Dense, moist, brown, fine to coarse, Sandy CONGLOMERATE				
BORING TERMINATED AT 27 FEET										

Figure A-75,
Log of Boring LB 6, Page 1 of 1

G2070-42-02.GPJ

SAMPLE SYMBOLS		... SAMPLING UNSUCCESSFUL		... STANDARD PENETRATION TEST		... DRIVE SAMPLE (UNDISTURBED)
		... DISTURBED OR BAG SAMPLE		... CHUNK SAMPLE		... WATER TABLE OR SEEPAGE

NOTE: THE LOG OF SUBSURFACE CONDITIONS SHOWN HEREON APPLIES ONLY AT THE SPECIFIC BORING OR TRENCH LOCATION AND AT THE DATE INDICATED. IT IS NOT WARRANTED TO BE REPRESENTATIVE OF SUBSURFACE CONDITIONS AT OTHER LOCATIONS AND TIMES.

DEPTH IN FEET	SAMPLE NO.	LITHOLOGY	GROUNDWATER	SOIL CLASS (USCS)	BORING LB 7		PENETRATION RESISTANCE (BLOWS/FT.)	DRY DENSITY (P.C.F.)	MOISTURE CONTENT (%)
					ELEV. (MSL.) <u>321'</u>	DATE COMPLETED <u>06-27-2017</u>			
					EQUIPMENT <u>BUCKET RIG</u>		BY: <u>BORJA/REIST</u>		
MATERIAL DESCRIPTION									
0				ML	UNDOCUMENTED FILL (Qudf) Firm to stiff, dry to damp, light brown, Sandy SILT; ~10%-20% gravel				
2				SM	Medium dense, moist, brown, Silty, fine to medium SAND; ~10%-20% gravel and cobble ±6" size				
4									
6	LB7-1						5		
8					-Trace asphalt concrete present at 8 feet				
10	LB7-2						2		
12									
14					-Geotechnically logged to 14 feet				
16	LB7-3		▼	SC	COLLUVIUM (Qc) Loose to medium dense, saturated, dark gray to black, Clayey, fine to medium SAND; ~10%-20% gravel and cobble; hole belled to ~8' below contact -Seepage at 15 feet -Standing water and caving at 17 feet		PUSH		
18			▼						
20									
					BORING TERMINATED AT 21 FEET DUE TO CAVING CONDITIONS				

Figure A-76,
Log of Boring LB 7, Page 1 of 1

G2070-42-02.GPJ

SAMPLE SYMBOLS		... SAMPLING UNSUCCESSFUL		... STANDARD PENETRATION TEST		... DRIVE SAMPLE (UNDISTURBED)
		... DISTURBED OR BAG SAMPLE		... CHUNK SAMPLE		... WATER TABLE OR SEEPAGE

NOTE: THE LOG OF SUBSURFACE CONDITIONS SHOWN HEREON APPLIES ONLY AT THE SPECIFIC BORING OR TRENCH LOCATION AND AT THE DATE INDICATED. IT IS NOT WARRANTED TO BE REPRESENTATIVE OF SUBSURFACE CONDITIONS AT OTHER LOCATIONS AND TIMES.

DEPTH IN FEET	SAMPLE NO.	LITHOLOGY	GROUNDWATER	SOIL CLASS (USCS)	BORING LB 8		PENETRATION RESISTANCE (BLOWS/FT.)	DRY DENSITY (P.C.F.)	MOISTURE CONTENT (%)
					ELEV. (MSL.) <u>253'</u>	DATE COMPLETED <u>06-28-2017</u>			
					EQUIPMENT <u>BUCKET RIG</u>	BY: <u>BORJA/REIST</u>			
MATERIAL DESCRIPTION									
0				SM	COMPACTED FILL (Qcf) Medium dense, moist, tan to brown, Silty, fine to medium SAND; 10% gravel and cobble; little clay				
2									
4	LB8-1			SC	Medium dense, moist, light brown, Clayey, fine to medium SAND; 10% gravel and cobble -Increase in moisture content below 7 feet	1			
6									
8				SM	Medium dense, moist, light brown, Silty, fine to medium SAND; 10% cobble and gravel -Becomes moist to wet below 12 feet				
10	LB8-2					2			
12									
14									
16	LB8-3		▽	CL	Firm to stiff, moist, tan brown, Sandy CLAY; 10% cobble and gravel; ±6" size; slight seepage at contact at 16 feet	4			
18				CL	ALLUVIUM (Qal) Firm to stiff, moist, wet, black to dark gray, Sandy CLAY; 10%-20% gravel and cobble ±6" size; hole slightly belled between 17-20 feet				
20	LB8-4			GM	STADIUM CONGLOMERATE (Tst) Dense, moist, brown to grayish brown, fine to coarse, Sandy CONGLOMERATE	8			
22									
24	LB8-5		▼			8			
26					BORING TERMINATED AT 26 FEET				

Figure A-77,
Log of Boring LB 8, Page 1 of 1

G2070-42-02.GPJ

SAMPLE SYMBOLS	... SAMPLING UNSUCCESSFUL	... STANDARD PENETRATION TEST	... DRIVE SAMPLE (UNDISTURBED)
	... DISTURBED OR BAG SAMPLE	... CHUNK SAMPLE	... WATER TABLE OR SEEPAGE

NOTE: THE LOG OF SUBSURFACE CONDITIONS SHOWN HEREON APPLIES ONLY AT THE SPECIFIC BORING OR TRENCH LOCATION AND AT THE DATE INDICATED. IT IS NOT WARRANTED TO BE REPRESENTATIVE OF SUBSURFACE CONDITIONS AT OTHER LOCATIONS AND TIMES.

DEPTH IN FEET	SAMPLE NO.	LITHOLOGY	GROUNDWATER	SOIL CLASS (USCS)	BORING LB 9		PENETRATION RESISTANCE (BLOWS/FT.)	DRY DENSITY (P.C.F.)	MOISTURE CONTENT (%)
					ELEV. (MSL.) 252'	DATE COMPLETED 06-30-2017			
					EQUIPMENT BUCKET RIG		BY: BORJA/REIST		
MATERIAL DESCRIPTION									
0				SM	COMPACTED FILL (Qcf) Medium dense, dry, light brown, Silty, fine to medium SAND; ~20%-30% gravel 3/8" to ±2" in diameter -Becomes moist and light brown with decrease in gravel content below 1.5 feet -Excavates with trace cobble ±3" in diameter				
2									
4									
6	LB9-1						2		
8					-Becomes brown with increase in moisture content below 8 ft.				
10	LB9-2						3		
12									
14				SC	Medium dense, moist, Clayey, fine to medium SAND; little gravel and cobble up to ±6" in diameter				
16	LB9-3						4		
18				SM&ML	ALLUVIUM (Qal) Medium dense, moist to wet, mottled dark brown to brown and black, Silty, fine to medium SAND to Sandy SILT; ~5%-15% gravel and cobble up to ±6"				
20	LB9-4						3		
22			▼	ML	-Seepage at 22 feet Stiff, moist to wet, dark gray to black, Sandy SILT; little gravel and cobble up to ±6"; interbedded with silty, fine to coarse sand; moderate caving and hole belled out below 22 ft.				
24				SM	Medium dense, wet to saturated, dark gray to black, Silty, fine to coarse SAND; some gravel and cobble up to ±7"; few organics				
26	LB9-5						2		
28				ML	Stiff, wet, dark gray, Sandy SILT; few gravel and cobble up to 10"				
				GM	STADIUM CONGLOMERATE (Tst)				

Figure A-78,
Log of Boring LB 9, Page 1 of 2

G2070-42-02.GPJ

SAMPLE SYMBOLS	■	... SAMPLING UNSUCCESSFUL	□	... STANDARD PENETRATION TEST	■	... DRIVE SAMPLE (UNDISTURBED)
	⊗	... DISTURBED OR BAG SAMPLE	■	... CHUNK SAMPLE	▼	... WATER TABLE OR SEEPAGE

NOTE: THE LOG OF SUBSURFACE CONDITIONS SHOWN HEREON APPLIES ONLY AT THE SPECIFIC BORING OR TRENCH LOCATION AND AT THE DATE INDICATED. IT IS NOT WARRANTED TO BE REPRESENTATIVE OF SUBSURFACE CONDITIONS AT OTHER LOCATIONS AND TIMES.

DEPTH IN FEET	SAMPLE NO.	LITHOLOGY	GROUNDWATER	SOIL CLASS (USCS)	BORING LB 10			PENETRATION RESISTANCE (BLOWS/FT.)	DRY DENSITY (P.C.F.)	MOISTURE CONTENT (%)
					ELEV. (MSL.) <u>295'</u>	DATE COMPLETED <u>06-30-2017</u>	EQUIPMENT <u>BUCKET RIG</u> BY: <u>BORJA/REIST</u>			
MATERIAL DESCRIPTION										
0				SM	UNDOCUMENTED FILL (Qudf) Loose, dry, brown to light brown, Gravely SAND					
2				SM&SC	COMPACTED FILL (Qcf) Medium dense, moist, tan brown, Silty to Clayey, fine to medium SAND; few gravel					
4				SM	Medium dense, moist, brown to tan, Silty, fine to medium SAND; trace gravel					
6	LB10-1						4			
8										
10				SC	Medium dense, moist, brown, Clayey, fine to medium SAND; few gravel					
12	LB10-2						3			
14										
16				SM	Medium dense, moist, brown, Silty, fine to medium SAND; trace gravel					
18	LB10-3						4			
20										
22	LB10-4						5	125.0	13.1	
24										
26	LB10-5						6			
28										

Figure A-79,
Log of Boring LB 10, Page 1 of 4

G2070-42-02.GPJ

SAMPLE SYMBOLS		
	... SAMPLING UNSUCCESSFUL	
	... DISTURBED OR BAG SAMPLE	
	... STANDARD PENETRATION TEST	
	... CHUNK SAMPLE	
	... WATER TABLE OR SEEPAGE	

NOTE: THE LOG OF SUBSURFACE CONDITIONS SHOWN HEREON APPLIES ONLY AT THE SPECIFIC BORING OR TRENCH LOCATION AND AT THE DATE INDICATED. IT IS NOT WARRANTED TO BE REPRESENTATIVE OF SUBSURFACE CONDITIONS AT OTHER LOCATIONS AND TIMES.

DEPTH IN FEET	SAMPLE NO.	LITHOLOGY	GROUNDWATER	SOIL CLASS (USCS)	BORING LB 10		PENETRATION RESISTANCE (BLOWS/FT.)	DRY DENSITY (P.C.F.)	MOISTURE CONTENT (%)
					ELEV. (MSL.) <u>295'</u>	DATE COMPLETED <u>06-30-2017</u>			
					EQUIPMENT <u>BUCKET RIG</u>		BY: <u>BORJA/REIST</u>		
MATERIAL DESCRIPTION									
30	LB10-6						7	105.1	9.2
32									
34									
36	LB10-7			SM	-Slight increase in moisture below 35 ft.		3		
38									
40	LB10-8			SC	Medium dense, moist, brown, Clayey, fine to medium SAND; trace gravel		3	105.0	14.8
42									
44				SM	Medium dense, moist, brown to olive brown, Silty, fine to medium SAND; few gravel and trace asphalt concrete				
46	LB10-9						7		
48									
50	LB10-10						10	124.8	11.4
52					-Becomes light brown and light gray; little gravel and cobble up to 6" with 6" thick concrete lens at 51.5 ft.				
54									
56	LB10-11						10		
58				SM&SC	Medium dense, moist, tan brown, Silty and Clayey, fine to coarse SAND; trace gravel				
				SM	Medium dense, moist, brown, Silty, fine to medium SAND; trace gravel and				

Figure A-79,
Log of Boring LB 10, Page 2 of 4

G2070-42-02.GPJ

SAMPLE SYMBOLS			
	... SAMPLING UNSUCCESSFUL		... STANDARD PENETRATION TEST
	... DISTURBED OR BAG SAMPLE		... DRIVE SAMPLE (UNDISTURBED)
	... CHUNK SAMPLE		... WATER TABLE OR SEEPAGE

NOTE: THE LOG OF SUBSURFACE CONDITIONS SHOWN HEREON APPLIES ONLY AT THE SPECIFIC BORING OR TRENCH LOCATION AND AT THE DATE INDICATED. IT IS NOT WARRANTED TO BE REPRESENTATIVE OF SUBSURFACE CONDITIONS AT OTHER LOCATIONS AND TIMES.

DEPTH IN FEET	SAMPLE NO.	LITHOLOGY	GROUNDWATER	SOIL CLASS (USCS)	BORING LB 10		PENETRATION RESISTANCE (BLOWS/FT.)	DRY DENSITY (P.C.F.)	MOISTURE CONTENT (%)
					ELEV. (MSL.) <u>295'</u>	DATE COMPLETED <u>06-30-2017</u>			
					EQUIPMENT <u>BUCKET RIG</u>		BY: <u>BORJA/REIST</u>		
MATERIAL DESCRIPTION									
60	LB10-12					few clay	13	111.7	10.3
62									
64									
66	LB10-13						7		
68									
70	LB10-14			CL		Very stiff, moist, black and dark gray, Sandy CLAY; some gravel and cobble ±4"; slight organic odor	15		12.8
72				SC		Medium dense, moist, mottled light brown and greenish gray, Clayey, fine to medium SAND; little gravel and cobble ±6"			
74			▼			-Increase in moisture content; becomes mottled brown, dark brown, and greenish gray; slight to moderate seepage at 74.5 ft.			
76	LB10-15			CL		Very stiff, wet, mottled dark gray, dark brown, and greenish gray, Sandy CLAY; few gravel and cobble ±4"	14		
78						-Becomes mottled dark brown and dark reddish brown at 79 ft.			
80	LB10-16					-Excavates with pockets of silty clay; slightly odorous at 80.5 ft.	25	100.1	20.4
82									
84									
86	LB10-17					-Becomes dark gray and black at 85 ft.	15		
88			▼	GM/GC		STADIUM CONGLOMERATE (Tst) Very dense, moist to wet, mottled light brown and greenish gray, Sandy CLAY CONGLOMERATE; hole belled out below contact -Standing water at 89 feet			

Figure A-79,
Log of Boring LB 10, Page 3 of 4

G2070-42-02.GPJ







SAMPLE SYMBOLS		... SAMPLING UNSUCCESSFUL		... STANDARD PENETRATION TEST		... DRIVE SAMPLE (UNDISTURBED)
		... DISTURBED OR BAG SAMPLE		... CHUNK SAMPLE		... WATER TABLE OR SEEPAGE

NOTE: THE LOG OF SUBSURFACE CONDITIONS SHOWN HEREON APPLIES ONLY AT THE SPECIFIC BORING OR TRENCH LOCATION AND AT THE DATE INDICATED. IT IS NOT WARRANTED TO BE REPRESENTATIVE OF SUBSURFACE CONDITIONS AT OTHER LOCATIONS AND TIMES.

DEPTH IN FEET	SAMPLE NO.	LITHOLOGY	GROUNDWATER	SOIL CLASS (USCS)	BORING LB 11		PENETRATION RESISTANCE (BLOWS/FT.)	DRY DENSITY (P.C.F.)	MOISTURE CONTENT (%)
					ELEV. (MSL.) 282'	DATE COMPLETED 11-02-2017			
					EQUIPMENT BUCKET RIG		BY: T. REIST		
MATERIAL DESCRIPTION									
0					12-inches of Concrete				
2				SM/SC	UNDOCUMENTED FILL (Qudf) Loose to medium dense, moist, brown, Silty/Clayey, fine to medium SAND with 10%-30% gravel and cobble size rock fragments up to 5-inches				
4									
6	LB11-1						1	119.0	12.3
8	LB11-2			SM	COMPACTED FILL (Qcf) Medium dense, moist, brown, Gravelly, fine to medium SAND with 20%-30% 1-inch gravel and some clay				
10	LB11-3						2	118.8	11.9
12									
14									
16	LB11-4						1	105.6	12.8
18				SC	Medium dense, moist, brown, Clayey, fine to medium SAND with 10% 1-inch gravel				
20	LB11-5						1	109.3	11.9
22									
24					-Becomes very moist below 24 feet				
26	LB11-6						1	116.9	12.5
28									

Figure A-80,
Log of Boring LB 11, Page 1 of 3

G2070-42-02.GPJ

SAMPLE SYMBOLS		... SAMPLING UNSUCCESSFUL		... STANDARD PENETRATION TEST		... DRIVE SAMPLE (UNDISTURBED)
		... DISTURBED OR BAG SAMPLE		... CHUNK SAMPLE		... WATER TABLE OR SEEPAGE

NOTE: THE LOG OF SUBSURFACE CONDITIONS SHOWN HEREON APPLIES ONLY AT THE SPECIFIC BORING OR TRENCH LOCATION AND AT THE DATE INDICATED. IT IS NOT WARRANTED TO BE REPRESENTATIVE OF SUBSURFACE CONDITIONS AT OTHER LOCATIONS AND TIMES.

DEPTH IN FEET	SAMPLE NO.	LITHOLOGY	GROUNDWATER	SOIL CLASS (USCS)	BORING LB 11		PENETRATION RESISTANCE (BLOWS/FT.)	DRY DENSITY (P.C.F.)	MOISTURE CONTENT (%)
					ELEV. (MSL.) 282'	DATE COMPLETED 11-02-2017			
					EQUIPMENT BUCKET RIG BY: T. REIST				
MATERIAL DESCRIPTION									
30	LB11-7			SC			1	111.8	14.5
32									
34									
36	LB11-8						2	116.4	15.0
38									
40	LB11-9						2	114.9	14.4
42									
44									
46	LB11-10					-Becomes very moist to wet below 45 feet	Push	109.8	17.0
48									
50	LB11-11						2	112.9	15.0
52									
54									
56	LB11-12				-Caving below 56 feet	1	118.2	10.7	
58				GM	-10%-30% gravel and cobble size rock fragments up to 10-inches with groundwater present at 58 feet				
					STADIUM CONGLOMERATE (Tst)				

Figure A-80,
Log of Boring LB 11, Page 2 of 3

G2070-42-02.GPJ







SAMPLE SYMBOLS			
	... SAMPLING UNSUCCESSFUL		... STANDARD PENETRATION TEST
	... DISTURBED OR BAG SAMPLE		... DRIVE SAMPLE (UNDISTURBED)
	... CHUNK SAMPLE		... WATER TABLE OR SEEPAGE

NOTE: THE LOG OF SUBSURFACE CONDITIONS SHOWN HEREON APPLIES ONLY AT THE SPECIFIC BORING OR TRENCH LOCATION AND AT THE DATE INDICATED. IT IS NOT WARRANTED TO BE REPRESENTATIVE OF SUBSURFACE CONDITIONS AT OTHER LOCATIONS AND TIMES.

DEPTH IN FEET	SAMPLE NO.	LITHOLOGY	GROUNDWATER	SOIL CLASS (USCS)	BORING LB 12		PENETRATION RESISTANCE (BLOWS/FT.)	DRY DENSITY (P.C.F.)	MOISTURE CONTENT (%)
					ELEV. (MSL.) 280	DATE COMPLETED 11-02-2017			
					EQUIPMENT BUCKET RIG		BY: T. REIST		
MATERIAL DESCRIPTION									
0					11-inches of Concrete				
2				SM/SC	UNDOCUMENTED FILL (Qudf) Loose to medium dense, damp to moist, brown, Clayey/Silty, fine to medium SAND with 5%-10% gravel and cobble size rock fragments up to 10-inches		2		
4									
6	LB13-1								
8									
10	LB13-2						Push		
12					-Becomes grayish brown with 20%-30% gravel and cobble size rock fragments up to 12-inches				
14				GM	STADIUM CONGLOMERATE (Tst) Dense, damp, gray and orange, fine to coarse, Sandy CONGLOMERATE with 50%-60% gravel and cobble size rock fragments up to 12-inches				
16					BORING TERMINATED AT 16 FEET				

Figure A-81,
Log of Boring LB 12, Page 1 of 1

G2070-42-02.GPJ







SAMPLE SYMBOLS	 ... SAMPLING UNSUCCESSFUL	 ... STANDARD PENETRATION TEST	 ... DRIVE SAMPLE (UNDISTURBED)
	 ... DISTURBED OR BAG SAMPLE	 ... CHUNK SAMPLE	 ... WATER TABLE OR SEEPAGE

NOTE: THE LOG OF SUBSURFACE CONDITIONS SHOWN HEREON APPLIES ONLY AT THE SPECIFIC BORING OR TRENCH LOCATION AND AT THE DATE INDICATED. IT IS NOT WARRANTED TO BE REPRESENTATIVE OF SUBSURFACE CONDITIONS AT OTHER LOCATIONS AND TIMES.

DEPTH IN FEET	SAMPLE NO.	LITHOLOGY	GROUNDWATER	SOIL CLASS (USCS)	BORING LB 13		PENETRATION RESISTANCE (BLOWS/FT.)	DRY DENSITY (P.C.F.)	MOISTURE CONTENT (%)
					ELEV. (MSL.) <u>281'</u>	DATE COMPLETED <u>11-02-2017</u>			
					EQUIPMENT <u>BUCKET RIG</u>		BY: <u>T. REIST</u>		
MATERIAL DESCRIPTION									
0				SM	UNDOCUMENTED FILL (Qudf) Loose to medium dense, damp, gray, Gravelly, fine to coarse SAND with 10%-30% 1 to 3-inch gravel				
2				SM	Loose to medium dense, damp to moist, brown, Silty, fine to medium SAND with 10% gravel size rock fragments up to 3-inches and some clay				
4					-Concrete lens at 5 feet				
6									
8				SM	COMPACTED FILL (Qcf) Medium dense, moist, brown, Silty, fine to medium SAND with random gravel and cobble lenses and some clay				
10	LB13-1					1	119.7	12.7	
12	LB13-2					5			
14									
16					-Sample disturbed due to gravels				
18				SM	ALLUVIUM (Qal) Loose, damp, dark brown, Silty, fine to medium SAND with 10%-30% gravel and cobble size rock fragments up to 10-inches				
20	LB13-3			SM	STADIUM CONGLOMERATE (Tst) Dense, damp, gray, Silty, fine to medium SANDSTONE	5/10"			
BORING TERMINATED AT 21 FEET									

Figure A-82,
Log of Boring LB 13, Page 1 of 1

G2070-42-02.GPJ







SAMPLE SYMBOLS	 ... SAMPLING UNSUCCESSFUL	 ... STANDARD PENETRATION TEST	 ... DRIVE SAMPLE (UNDISTURBED)
	 ... DISTURBED OR BAG SAMPLE	 ... CHUNK SAMPLE	 ... WATER TABLE OR SEEPAGE

NOTE: THE LOG OF SUBSURFACE CONDITIONS SHOWN HEREON APPLIES ONLY AT THE SPECIFIC BORING OR TRENCH LOCATION AND AT THE DATE INDICATED. IT IS NOT WARRANTED TO BE REPRESENTATIVE OF SUBSURFACE CONDITIONS AT OTHER LOCATIONS AND TIMES.

DEPTH IN FEET	SAMPLE NO.	LITHOLOGY	GROUNDWATER	SOIL CLASS (USCS)	BORING LB 14		PENETRATION RESISTANCE (BLOWS/FT.)	DRY DENSITY (P.C.F.)	MOISTURE CONTENT (%)
					ELEV. (MSL.) <u>274'</u>	DATE COMPLETED <u>11-02-2017</u>			
					EQUIPMENT <u>BUCKET RIG</u>		BY: <u>T. REIST</u>		
MATERIAL DESCRIPTION									
0				GM	UNDOCUMENTED FILL (Qudf) Loose, dry, gray, Silty/Sandy GRAVEL with 50%-60% 1 to 3-inch gravel				
2									
4				SM	COMPACTED FILL (Qcf) Medium dense to dense, moist, brown to gray, Silty, fine to medium SAND with 10%-30% gravel and cobble size rock fragments up to 10-inches				
6	LB14-1				-Slow drilling; auger used throughout; odor of cement present in cuttings		2/5"	114.9	11.0
8					-Thin concrete layers present below 9 feet				
10	LB14-2						5	116.8	13.8
12									
14									
16									
18									
20	LB14-3				-Becomes wet below 20 feet		2	119.7	11.9
22									
24									
26	LB14-4						5/8"	124.8	8.3
28				CL	Stiff, wet, dark brown and gray, Sandy/Gravelly CLAY with 20%-40% gravel and cobble size rock fragments up to 16-inches				

Figure A-83,
Log of Boring LB 14, Page 1 of 2

G2070-42-02.GPJ

SAMPLE SYMBOLS	 ... SAMPLING UNSUCCESSFUL	 ... STANDARD PENETRATION TEST	 ... DRIVE SAMPLE (UNDISTURBED)
	 ... DISTURBED OR BAG SAMPLE	 ... CHUNK SAMPLE	 ... WATER TABLE OR SEEPAGE

NOTE: THE LOG OF SUBSURFACE CONDITIONS SHOWN HEREON APPLIES ONLY AT THE SPECIFIC BORING OR TRENCH LOCATION AND AT THE DATE INDICATED. IT IS NOT WARRANTED TO BE REPRESENTATIVE OF SUBSURFACE CONDITIONS AT OTHER LOCATIONS AND TIMES.







DEPTH IN FEET	SAMPLE NO.	LITHOLOGY	GROUNDWATER	SOIL CLASS (USCS)	BORING LB 14		PENETRATION RESISTANCE (BLOWS/FT.)	DRY DENSITY (P.C.F.)	MOISTURE CONTENT (%)
					ELEV. (MSL.) <u>274'</u>	DATE COMPLETED <u>11-02-2017</u>			
					EQUIPMENT <u>BUCKET RIG</u>		BY: <u>T. REIST</u>		
MATERIAL DESCRIPTION									
30				CL	-Some clay pipe present at 30 feet				
32				SC	Medium dense, wet, brown, Clayey, fine to medium SAND with with 10%-15% gravel and cobble size rock fragments up to 6-inches; concrete pieces throughout				
34	LB14-5						5/8"	116.0	15.7
36									
38			▼	SC/SM	-Groundwater present at contact at 37 feet ALLUVIUM (Qal) Stiff, wet, dark brown, Clayey/Gravelly SAND with 30%-40% gravel and cobble size rock fragments up to 10-inches; severe caving				
40					BORING TERMINATED AT 40 FEET DUE TO CAVING				

Figure A-83,
Log of Boring LB 14, Page 2 of 2

G2070-42-02.GPJ

SAMPLE SYMBOLS		... SAMPLING UNSUCCESSFUL		... STANDARD PENETRATION TEST		... DRIVE SAMPLE (UNDISTURBED)
		... DISTURBED OR BAG SAMPLE		... CHUNK SAMPLE		... WATER TABLE OR SEEPAGE

NOTE: THE LOG OF SUBSURFACE CONDITIONS SHOWN HEREON APPLIES ONLY AT THE SPECIFIC BORING OR TRENCH LOCATION AND AT THE DATE INDICATED. IT IS NOT WARRANTED TO BE REPRESENTATIVE OF SUBSURFACE CONDITIONS AT OTHER LOCATIONS AND TIMES.

DEPTH IN FEET	SAMPLE NO.	LITHOLOGY	GROUNDWATER	SOIL CLASS (USCS)	BORING LB 15		PENETRATION RESISTANCE (BLOWS/FT.)	DRY DENSITY (P.C.F.)	MOISTURE CONTENT (%)
					ELEV. (MSL.) <u>265.5'</u>	DATE COMPLETED <u>11-03-2017</u>			
					EQUIPMENT <u>BUCKET RIG</u>		BY: <u>T. REIST</u>		
MATERIAL DESCRIPTION									
0					SM	4-inches of Asphalt Concrete			
2					SM	UNDOCUMENTED FILL (Qudf) Loose to medium dense, damp, brown to light brown, Silty, fine to medium SAND with 10%-20% gravel, cobble and boulder size rock fragments up to 14-inches			
4					SM	Loose to medium dense, damp, light brown to brown, Gravelly, fine to coarse SAND with 30%-40% gravel, cobble and boulder size rock fragments up to 16-inches; auger used; slow drilling			
6									
8					GM	COMPACTED FILL (Qcf) Medium dense, moist, brown, fine to coarse, Sandy GRAVEL with 50%-60% gravel, cobble and boulder size rock fragments up to 16-inches			
10									
12									
14									
16									
18									
20						-Becomes darker brown with some dark green claystone chunks in fill below 19 feet			
22			▼			-Groundwater at 22 feet			
24					GM	STADIUM CONGLOMERATE (Tst) Dense, wet, orange brown, fine to medium, Sandy CONGLOMERATE with 50%-60% gravel and cobble size rock fragments			
BORING TERMINATED AT 24 FEET									

Figure A-84,
Log of Boring LB 15, Page 1 of 1

G2070-42-02.GPJ

SAMPLE SYMBOLS	■ ... SAMPLING UNSUCCESSFUL	□ ... STANDARD PENETRATION TEST	■ ... DRIVE SAMPLE (UNDISTURBED)
	⊗ ... DISTURBED OR BAG SAMPLE	▣ ... CHUNK SAMPLE	▼ ... WATER TABLE OR SEEPAGE

NOTE: THE LOG OF SUBSURFACE CONDITIONS SHOWN HEREON APPLIES ONLY AT THE SPECIFIC BORING OR TRENCH LOCATION AND AT THE DATE INDICATED. IT IS NOT WARRANTED TO BE REPRESENTATIVE OF SUBSURFACE CONDITIONS AT OTHER LOCATIONS AND TIMES.

DEPTH IN FEET	SAMPLE NO.	LITHOLOGY	GROUNDWATER	SOIL CLASS (USCS)	BORING LB 16		PENETRATION RESISTANCE (BLOWS/FT.)	DRY DENSITY (P.C.F.)	MOISTURE CONTENT (%)
					ELEV. (MSL.) <u>249'</u>	DATE COMPLETED <u>11-03-2017</u>			
					EQUIPMENT <u>BUCKET RIG</u>		BY: <u>T. REIST</u>		
MATERIAL DESCRIPTION									
0				GM	UNDOCUMENTED FILL (Qudf) Loose, dry, gray, 3/4-inch GRAVEL				
2				SM	COMPACTED FILL (Qcf) Medium dense, moist, brown, Silty/Gravelly, fine to medium SAND with 20%-40% gravel and trace cobble				
6	LB16-1						2	119.0	12.2
8	LB16-2								
10	LB16-3				-Sample disturbed; shoe destroyed on gravels		6		
14					-Becomes gray-brown from 13-14 feet				
16	LB16-4				-Sample disturbed due to gravel		3		
20				GM/GC	Medium dense, moist to wet, dark gray, Sandy/Clayey GRAVEL with 50% gravel and cobble size rock fragments up to 10-inches and some organics				
24					-Becomes gray-brown below 23 feet -Becomes orange-brown from 24-26 feet				
26					-Becomes dark gray and brown below 26 feet				
28				GM/GC	ALLUVIUM (Qal) Loose, wet, dark gray, Sandy/Clayey GRAVEL with 50% gravel, cobble and boulder size rock fragments up to 16-inches; moderate caving				

Figure A-85,
Log of Boring LB 16, Page 1 of 2

G2070-42-02.GPJ

SAMPLE SYMBOLS		... SAMPLING UNSUCCESSFUL		... STANDARD PENETRATION TEST		... DRIVE SAMPLE (UNDISTURBED)
		... DISTURBED OR BAG SAMPLE		... CHUNK SAMPLE		... WATER TABLE OR SEEPAGE

NOTE: THE LOG OF SUBSURFACE CONDITIONS SHOWN HEREON APPLIES ONLY AT THE SPECIFIC BORING OR TRENCH LOCATION AND AT THE DATE INDICATED. IT IS NOT WARRANTED TO BE REPRESENTATIVE OF SUBSURFACE CONDITIONS AT OTHER LOCATIONS AND TIMES.







DEPTH IN FEET	SAMPLE NO.	LITHOLOGY	GROUNDWATER	SOIL CLASS (USCS)	BORING LB 16 ELEV. (MSL.) <u>249'</u> DATE COMPLETED <u>11-03-2017</u> EQUIPMENT <u>BUCKET RIG</u> BY: <u>T. REIST</u>	PENETRATION RESISTANCE (BLOWS/FT.)	DRY DENSITY (P.C.F.)	MOISTURE CONTENT (%)
30				GM/GC	-Groundwater at 30 feet			
BORING TERMINATED AT 31 FEET DUE TO CAVING								

Figure A-85,
Log of Boring LB 16, Page 2 of 2

G2070-42-02.GPJ

SAMPLE SYMBOLS	 ... SAMPLING UNSUCCESSFUL	 ... STANDARD PENETRATION TEST	 ... DRIVE SAMPLE (UNDISTURBED)
	 ... DISTURBED OR BAG SAMPLE	 ... CHUNK SAMPLE	 ... WATER TABLE OR SEEPAGE

NOTE: THE LOG OF SUBSURFACE CONDITIONS SHOWN HEREON APPLIES ONLY AT THE SPECIFIC BORING OR TRENCH LOCATION AND AT THE DATE INDICATED. IT IS NOT WARRANTED TO BE REPRESENTATIVE OF SUBSURFACE CONDITIONS AT OTHER LOCATIONS AND TIMES.

DEPTH IN FEET	SAMPLE NO.	LITHOLOGY	GROUNDWATER	SOIL CLASS (USCS)	BORING LB 17		PENETRATION RESISTANCE (BLOWS/FT.)	DRY DENSITY (P.C.F.)	MOISTURE CONTENT (%)
					ELEV. (MSL.) 248'	DATE COMPLETED 11-03-2017			
					EQUIPMENT BUCKET RIG BY: T. REIST				
MATERIAL DESCRIPTION									
0				SM	UNDOCUMENTED FILL (Qudf) Medium dense, dry to damp, Gravelly, fine to medium SAND with 20% gravel size rock fragments up to 3-inches				
2				SM	COMPACTED FILL (Qcf) Medium dense to dense, damp to moist, brown, Gravelly, fine to medium SAND with 30%-40% gravel size rock fragments up to 3-inches and trace cobble up to 10-inches				
4	LB17-1				-Becomes dark gray with some clay and organics from 7 to 10 feet		4	115.8	8.7
6									
8									
10									
10	LB17-2			SM	Medium dense, damp, brown, Silty, fine to medium SAND with 10%-15% gravel size rock fragments up to 2-inches and trace cobble size rock fragments up to 8-inches		1	108.6	8.7
12	LB17-3				-Gravel in shoe		5	115.2	9.4
14									
16									
18	LB17-4						2	101.9	12.1
20	LB17-5						1	108.0	13.2
22									
24									
26									
28				SM	ALLUVIUM (Qal) Loose to medium dense, damp, dark gray, Gravelly, fine to coarse SAND with 30% gravel and cobble size rock fragments up to 8-inches				

Figure A-86,
Log of Boring LB 17, Page 1 of 2

G2070-42-02.GPJ

SAMPLE SYMBOLS		... SAMPLING UNSUCCESSFUL		... STANDARD PENETRATION TEST		... DRIVE SAMPLE (UNDISTURBED)
		... DISTURBED OR BAG SAMPLE		... CHUNK SAMPLE		... WATER TABLE OR SEEPAGE

NOTE: THE LOG OF SUBSURFACE CONDITIONS SHOWN HEREON APPLIES ONLY AT THE SPECIFIC BORING OR TRENCH LOCATION AND AT THE DATE INDICATED. IT IS NOT WARRANTED TO BE REPRESENTATIVE OF SUBSURFACE CONDITIONS AT OTHER LOCATIONS AND TIMES.







DEPTH IN FEET	SAMPLE NO.	LITHOLOGY	GROUNDWATER	SOIL CLASS (USCS)	BORING LB 17		PENETRATION RESISTANCE (BLOWS/FT.)	DRY DENSITY (P.C.F.)	MOISTURE CONTENT (%)
					ELEV. (MSL.) <u>248'</u>	DATE COMPLETED <u>11-03-2017</u>			
					EQUIPMENT <u>BUCKET RIG</u>		BY: <u>T. REIST</u>		
MATERIAL DESCRIPTION									
30				SM	Medium dense, moist, dark brown with dark green, Clayey, fine to coarse SAND with 10%-20% gravel and cobble size rock fragments up to 6-inches with organics				
32									
34				GM	STADIUM CONGLOMERATE (Tst) Dense, damp, light brown, fine to coarse, Sandy CONGLOMERATE with 50% gravel and cobble size rock fragments up to 6-inches				
36									
			▼	-Groundwater at 37 feet					
BORING TERMINATED AT 37 FEET									

Figure A-86,
Log of Boring LB 17, Page 2 of 2

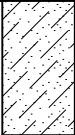
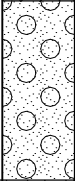
G2070-42-02.GPJ

SAMPLE SYMBOLS	 ... SAMPLING UNSUCCESSFUL	 ... STANDARD PENETRATION TEST	 ... DRIVE SAMPLE (UNDISTURBED)
	 ... DISTURBED OR BAG SAMPLE	 ... CHUNK SAMPLE	 ... WATER TABLE OR SEEPAGE

NOTE: THE LOG OF SUBSURFACE CONDITIONS SHOWN HEREON APPLIES ONLY AT THE SPECIFIC BORING OR TRENCH LOCATION AND AT THE DATE INDICATED. IT IS NOT WARRANTED TO BE REPRESENTATIVE OF SUBSURFACE CONDITIONS AT OTHER LOCATIONS AND TIMES.







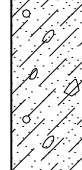
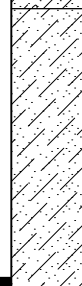

DEPTH IN FEET	SAMPLE NO.	LITHOLOGY	GROUNDWATER	SOIL CLASS (USCS)	BORING SB 1		PENETRATION RESISTANCE (BLOWS/FT.)	DRY DENSITY (P.C.F.)	MOISTURE CONTENT (%)	
					ELEV. (MSL.) <u>298'</u>	DATE COMPLETED <u>07-17-2017</u>				
					EQUIPMENT <u>CME 75</u>		BY: <u>G. CANNON</u>			
MATERIAL DESCRIPTION										
0				SC	UNDOCUMENTED FILL (Qudf) Medium dense, moist, dark olive brown, Clayey, fine to coarse SAND with gravel					
2										
4				SC	COMPACTED FILL (Qcf) Medium dense, moist, light olive, Clayey, fine to coarse SAND; trace gravel					
6										
8										
10	SB1-1						34			
12										
14										
16										
18										
20	SB1-2					-Becomes dense and dark yellowish brown below 20 feet		58	109.8	12.3
22										
24										
26										
28										

Figure A-87,
Log of Boring SB 1, Page 1 of 3

G2070-42-02.GPJ

SAMPLE SYMBOLS			
	... SAMPLING UNSUCCESSFUL		... STANDARD PENETRATION TEST
	... DISTURBED OR BAG SAMPLE		... DRIVE SAMPLE (UNDISTURBED)
	... CHUNK SAMPLE		... WATER TABLE OR SEEPAGE

NOTE: THE LOG OF SUBSURFACE CONDITIONS SHOWN HEREON APPLIES ONLY AT THE SPECIFIC BORING OR TRENCH LOCATION AND AT THE DATE INDICATED. IT IS NOT WARRANTED TO BE REPRESENTATIVE OF SUBSURFACE CONDITIONS AT OTHER LOCATIONS AND TIMES.

DEPTH IN FEET	SAMPLE NO.	LITHOLOGY	GROUNDWATER	SOIL CLASS (USCS)	BORING SB 1		PENETRATION RESISTANCE (BLOWS/FT.)	DRY DENSITY (P.C.F.)	MOISTURE CONTENT (%)	
					ELEV. (MSL.) <u>298'</u>	DATE COMPLETED <u>07-17-2017</u>				
					EQUIPMENT <u>CME 75</u> BY: <u>G. CANNON</u>					
					MATERIAL DESCRIPTION					
30	SB1-3			SC	-Becomes dense and olive brown below 30 feet		32	117.0	13.4	
32										
34										
36										
38										
40	SB1-4					-Becomes dense and light yellowish brown below 40 feet		67	112.6	9.2
42										
44										
46										
48										
50	SB1-5						76/11"	116.5	10.3	
52										
54										
56										
58										

Figure A-87,
Log of Boring SB 1, Page 2 of 3

G2070-42-02.GPJ

SAMPLE SYMBOLS	... SAMPLING UNSUCCESSFUL	... STANDARD PENETRATION TEST	... DRIVE SAMPLE (UNDISTURBED)
	... DISTURBED OR BAG SAMPLE	... CHUNK SAMPLE	... WATER TABLE OR SEEPAGE

NOTE: THE LOG OF SUBSURFACE CONDITIONS SHOWN HEREON APPLIES ONLY AT THE SPECIFIC BORING OR TRENCH LOCATION AND AT THE DATE INDICATED. IT IS NOT WARRANTED TO BE REPRESENTATIVE OF SUBSURFACE CONDITIONS AT OTHER LOCATIONS AND TIMES.







DEPTH IN FEET	SAMPLE NO.	LITHOLOGY	GROUNDWATER	SOIL CLASS (USCS)	BORING SB 1		PENETRATION RESISTANCE (BLOWS/FT.)	DRY DENSITY (P.C.F.)	MOISTURE CONTENT (%)
					ELEV. (MSL.) <u>298'</u>	DATE COMPLETED <u>07-17-2017</u>			
					EQUIPMENT <u>CME 75</u> BY: <u>G. CANNON</u>				
MATERIAL DESCRIPTION									
60	SB1-6			SC	-Becomes medium dense below 60 feet		37	115.9	10.3
62									
64									
66									
68									
70	SB1-7			SM	STADIUM CONGLOMERATE (Tst) Very dense, moist, mottled gray and red brown, Silty, fine SAND		50/3"		
72					-Cobble present at 72 feet -Refusal on cobble				
					BORING TERMINATED AT 73 FEET Groundwater not encountered				

Figure A-87,
Log of Boring SB 1, Page 3 of 3

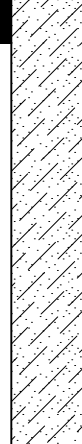
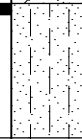
G2070-42-02.GPJ

SAMPLE SYMBOLS		... SAMPLING UNSUCCESSFUL		... STANDARD PENETRATION TEST		... DRIVE SAMPLE (UNDISTURBED)
		... DISTURBED OR BAG SAMPLE		... CHUNK SAMPLE		... WATER TABLE OR SEEPAGE

NOTE: THE LOG OF SUBSURFACE CONDITIONS SHOWN HEREON APPLIES ONLY AT THE SPECIFIC BORING OR TRENCH LOCATION AND AT THE DATE INDICATED. IT IS NOT WARRANTED TO BE REPRESENTATIVE OF SUBSURFACE CONDITIONS AT OTHER LOCATIONS AND TIMES.









DEPTH IN FEET	SAMPLE NO.	LITHOLOGY	GROUNDWATER	SOIL CLASS (USCS)	BORING SB 2		PENETRATION RESISTANCE (BLOWS/FT.)	DRY DENSITY (P.C.F.)	MOISTURE CONTENT (%)
					ELEV. (MSL.) <u>305'</u>	DATE COMPLETED <u>07-17-2017</u>			
					EQUIPMENT <u>CME 75</u>		BY: <u>G. CANNON</u>		
MATERIAL DESCRIPTION									
0				SM/SC	UNDOCUMENTED FILL (Qudf) Loose to medium dense, damp, dark yellowish brown, Silty to Clayey, fine to coarse SAND with some gravel				
2									
4									
6									
8				SC	COMPACTED FILL (Qcf) Dense to medium dense, moist, dark yellow brown, Clayey, fine to coarse SAND; some gravel				
10	SB2-1						64	119.2	10.0
12									
14									
16									
18									
20	SB2-2				-Becomes brown below 20 feet		84	113.9	9.0
22									
24									
26									
28									

Figure A-88,
Log of Boring SB 2, Page 1 of 4

G2070-42-02.GPJ

SAMPLE SYMBOLS			
	... SAMPLING UNSUCCESSFUL		... STANDARD PENETRATION TEST
	... DISTURBED OR BAG SAMPLE		... DRIVE SAMPLE (UNDISTURBED)
			... CHUNK SAMPLE
			... WATER TABLE OR SEEPAGE

NOTE: THE LOG OF SUBSURFACE CONDITIONS SHOWN HEREON APPLIES ONLY AT THE SPECIFIC BORING OR TRENCH LOCATION AND AT THE DATE INDICATED. IT IS NOT WARRANTED TO BE REPRESENTATIVE OF SUBSURFACE CONDITIONS AT OTHER LOCATIONS AND TIMES.

DEPTH IN FEET	SAMPLE NO.	LITHOLOGY	GROUNDWATER	SOIL CLASS (USCS)	BORING SB 2		PENETRATION RESISTANCE (BLOWS/FT.)	DRY DENSITY (P.C.F.)	MOISTURE CONTENT (%)	
					ELEV. (MSL.) <u>305'</u>	DATE COMPLETED <u>07-17-2017</u>				
					EQUIPMENT <u>CME 75</u> BY: <u>G. CANNON</u>					
MATERIAL DESCRIPTION										
30	SB2-3			SC			77	121.1	9.5	
32										
34										
36										
38										
40	SB2-4						-Becomes very dense below 40 feet	92/10"	119.8	9.9
42										
44										
46										
48										
50	SB2-5				-Becomes medium dense below 50 feet	31	112.6	13.7		
52										
54										
56										
58										

Figure A-88,
Log of Boring SB 2, Page 2 of 4

G2070-42-02.GPJ

SAMPLE SYMBOLS		... SAMPLING UNSUCCESSFUL		... STANDARD PENETRATION TEST		... DRIVE SAMPLE (UNDISTURBED)
		... DISTURBED OR BAG SAMPLE		... CHUNK SAMPLE		... WATER TABLE OR SEEPAGE

NOTE: THE LOG OF SUBSURFACE CONDITIONS SHOWN HEREON APPLIES ONLY AT THE SPECIFIC BORING OR TRENCH LOCATION AND AT THE DATE INDICATED. IT IS NOT WARRANTED TO BE REPRESENTATIVE OF SUBSURFACE CONDITIONS AT OTHER LOCATIONS AND TIMES.

DEPTH IN FEET	SAMPLE NO.	LITHOLOGY	GROUNDWATER	SOIL CLASS (USCS)	BORING SB 2		PENETRATION RESISTANCE (BLOWS/FT.)	DRY DENSITY (P.C.F.)	MOISTURE CONTENT (%)
					ELEV. (MSL.) <u>305'</u>	DATE COMPLETED <u>07-17-2017</u>			
					EQUIPMENT <u>CME 75</u> BY: <u>G. CANNON</u>				
MATERIAL DESCRIPTION									
60	SB2-6			SC			79	117.5	10.3
62									
64									
66									
68									
70	SB2-7						76	123.6	10.2
72									
74									
76									
78									
80									
82									
84	SB2-8					56	111.4	14.9	
86									
88									

Figure A-88,
Log of Boring SB 2, Page 3 of 4

G2070-42-02.GPJ

SAMPLE SYMBOLS	... SAMPLING UNSUCCESSFUL	... STANDARD PENETRATION TEST	... DRIVE SAMPLE (UNDISTURBED)
	... DISTURBED OR BAG SAMPLE	... CHUNK SAMPLE	... WATER TABLE OR SEEPAGE

NOTE: THE LOG OF SUBSURFACE CONDITIONS SHOWN HEREON APPLIES ONLY AT THE SPECIFIC BORING OR TRENCH LOCATION AND AT THE DATE INDICATED. IT IS NOT WARRANTED TO BE REPRESENTATIVE OF SUBSURFACE CONDITIONS AT OTHER LOCATIONS AND TIMES.







DEPTH IN FEET	SAMPLE NO.	LITHOLOGY	GROUNDWATER	SOIL CLASS (USCS)	BORING SB 2		PENETRATION RESISTANCE (BLOWS/FT.)	DRY DENSITY (P.C.F.)	MOISTURE CONTENT (%)
					ELEV. (MSL.) <u>305'</u>	DATE COMPLETED <u>07-17-2017</u>			
					EQUIPMENT <u>CME 75</u> BY: <u>G. CANNON</u>				
					MATERIAL DESCRIPTION				
90	SB2-9			SC	-No recovery		77		
	SB2-10						49		
92									
94									
96	SB2-11				-Groundwater encountered at 96 feet		88/8"		
98				GM	STADIUM CONGLOMERATE (Tst) Very dense, saturated, brown, fine to coarse, Sandy CONGLOMERATE; difficult drilling below 96.5 feet				
100	SB2-12								
					BORING TERMINATED AT 100.5 FEET Groundwater encountered at 96 feet				

Figure A-88,
Log of Boring SB 2, Page 4 of 4

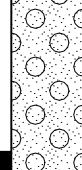
G2070-42-02.GPJ

SAMPLE SYMBOLS	 ... SAMPLING UNSUCCESSFUL	 ... STANDARD PENETRATION TEST	 ... DRIVE SAMPLE (UNDISTURBED)
	 ... DISTURBED OR BAG SAMPLE	 ... CHUNK SAMPLE	 ... WATER TABLE OR SEEPAGE

NOTE: THE LOG OF SUBSURFACE CONDITIONS SHOWN HEREON APPLIES ONLY AT THE SPECIFIC BORING OR TRENCH LOCATION AND AT THE DATE INDICATED. IT IS NOT WARRANTED TO BE REPRESENTATIVE OF SUBSURFACE CONDITIONS AT OTHER LOCATIONS AND TIMES.

DEPTH IN FEET	SAMPLE NO.	LITHOLOGY	GROUNDWATER	SOIL CLASS (USCS)	BORING SB 3		PENETRATION RESISTANCE (BLOWS/FT.)	DRY DENSITY (P.C.F.)	MOISTURE CONTENT (%)
					ELEV. (MSL.) <u>324'</u>	DATE COMPLETED <u>07-18-2017</u>			
					EQUIPMENT <u>CME 75</u> BY: <u>N. BORJA</u>				
					MATERIAL DESCRIPTION				
0				GM	UNDOCUMENTED FILL (Qudf) Medium dense, damp, brown, Sandy GRAVEL; some silt				
2									
4				SC	COMPACTED FILL (Qcf) Medium dense, moist, olive brown to brown, Clayey, fine to medium SAND; few gravel				
6									
8				CL	Stiff, moist, olive brown to grayish brown, Sandy CLAY; trace				
10	SB3-1			SM	Medium dense, moist, mottled brown and light gray, Silty, fine to medium SAND; trace gravel	32			
12									
14				CL	Stiff, moist, olive brown, Sandy CLAY; trace gravel; trace boulder at 14 feet				
16				SM	Medium dense, moist, grayish brown, Silty, fine to medium SAND; trace gravel				
18									
20	SB3-2			SM	Medium dense, moist, tan brown, Silty, fine to medium SAND; fine gravel	45	119.0	10.5	
22									
24									
26					-Becomes olive brown to grayish brown				
28									

Figure A-89,
Log of Boring SB 3, Page 1 of 4

G2070-42-02.GPJ

SAMPLE SYMBOLS		... SAMPLING UNSUCCESSFUL		... STANDARD PENETRATION TEST		... DRIVE SAMPLE (UNDISTURBED)
		... DISTURBED OR BAG SAMPLE		... CHUNK SAMPLE		... WATER TABLE OR SEEPAGE

NOTE: THE LOG OF SUBSURFACE CONDITIONS SHOWN HEREON APPLIES ONLY AT THE SPECIFIC BORING OR TRENCH LOCATION AND AT THE DATE INDICATED. IT IS NOT WARRANTED TO BE REPRESENTATIVE OF SUBSURFACE CONDITIONS AT OTHER LOCATIONS AND TIMES.

DEPTH IN FEET	SAMPLE NO.	LITHOLOGY	GROUNDWATER	SOIL CLASS (USCS)	BORING SB 3		PENETRATION RESISTANCE (BLOWS/FT.)	DRY DENSITY (P.C.F.)	MOISTURE CONTENT (%)
					ELEV. (MSL.) <u>324'</u>	DATE COMPLETED <u>07-18-2017</u>			
					EQUIPMENT <u>CME 75</u>		BY: <u>N. BORJA</u>		
MATERIAL DESCRIPTION									
30	SB3-3			SM	-Becomes brown; few gravel		66	118.4	11.1
32									
34									
36									
38									
40	SB3-4				-Becomes very dense		82	119.0	12.5
42									
44									
46									
48				SC	Dense, moist, brown, Clayey, fine to medium SAND; trace gravel				
50	SB3-5						60	119.1	13.5
52									
54									
56									
58									

Figure A-89,
Log of Boring SB 3, Page 2 of 4

G2070-42-02.GPJ

SAMPLE SYMBOLS	... SAMPLING UNSUCCESSFUL	... STANDARD PENETRATION TEST	... DRIVE SAMPLE (UNDISTURBED)
	... DISTURBED OR BAG SAMPLE	... CHUNK SAMPLE	... WATER TABLE OR SEEPAGE

NOTE: THE LOG OF SUBSURFACE CONDITIONS SHOWN HEREON APPLIES ONLY AT THE SPECIFIC BORING OR TRENCH LOCATION AND AT THE DATE INDICATED. IT IS NOT WARRANTED TO BE REPRESENTATIVE OF SUBSURFACE CONDITIONS AT OTHER LOCATIONS AND TIMES.







DEPTH IN FEET	SAMPLE NO.	LITHOLOGY	GROUNDWATER	SOIL CLASS (USCS)	BORING SB 3		PENETRATION RESISTANCE (BLOWS/FT.)	DRY DENSITY (P.C.F.)	MOISTURE CONTENT (%)
					ELEV. (MSL.) <u>324'</u>	DATE COMPLETED <u>07-18-2017</u>			
					EQUIPMENT <u>CME 75</u>		BY: <u>N. BORJA</u>		
MATERIAL DESCRIPTION									
60	SB3-6			SC			55	122.4	10.6
62									
64									
66									
68									
70									
72									
74									
76									
78				SM	Dense, moist, tan brown, Silty, fine to medium SAND; trace gravel				
80	SB3-7						66		
82									
84									
86									
88									

Figure A-89,
Log of Boring SB 3, Page 3 of 4

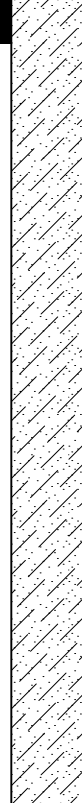
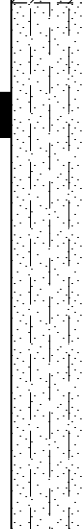
G2070-42-02.GPJ

SAMPLE SYMBOLS	 ... SAMPLING UNSUCCESSFUL	 ... STANDARD PENETRATION TEST	 ... DRIVE SAMPLE (UNDISTURBED)
	 ... DISTURBED OR BAG SAMPLE	 ... CHUNK SAMPLE	 ... WATER TABLE OR SEEPAGE

NOTE: THE LOG OF SUBSURFACE CONDITIONS SHOWN HEREON APPLIES ONLY AT THE SPECIFIC BORING OR TRENCH LOCATION AND AT THE DATE INDICATED. IT IS NOT WARRANTED TO BE REPRESENTATIVE OF SUBSURFACE CONDITIONS AT OTHER LOCATIONS AND TIMES.









DEPTH IN FEET	SAMPLE NO.	LITHOLOGY	GROUNDWATER	SOIL CLASS (USCS)	BORING SB 3		PENETRATION RESISTANCE (BLOWS/FT.)	DRY DENSITY (P.C.F.)	MOISTURE CONTENT (%)
					ELEV. (MSL.) <u>324'</u>	DATE COMPLETED <u>07-18-2017</u>			
					EQUIPMENT <u>CME 75</u>		BY: <u>N. BORJA</u>		
MATERIAL DESCRIPTION									
90									
92									
94									
96									
98									
100	SB3-8						65	117.3	13.0
102									
104									
106	SB3-9						50/2"		
108									
110						-Groundwater encountered at 110 feet			
112				GM		STADIUM CONGLOMERATE (Tst) Very dense, saturated, brown, fine to coarse, Sandy CONGLOMERATE			
114									
					BORING TERMINATED AT 115.5 FEET Groundwater encountered at 110 feet				

Figure A-89,
Log of Boring SB 3, Page 4 of 4

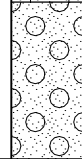
G2070-42-02.GPJ







SAMPLE SYMBOLS	 ... SAMPLING UNSUCCESSFUL	 ... STANDARD PENETRATION TEST	 ... DRIVE SAMPLE (UNDISTURBED)
	 ... DISTURBED OR BAG SAMPLE	 ... CHUNK SAMPLE	 ... WATER TABLE OR SEEPAGE

NOTE: THE LOG OF SUBSURFACE CONDITIONS SHOWN HEREON APPLIES ONLY AT THE SPECIFIC BORING OR TRENCH LOCATION AND AT THE DATE INDICATED. IT IS NOT WARRANTED TO BE REPRESENTATIVE OF SUBSURFACE CONDITIONS AT OTHER LOCATIONS AND TIMES.

DEPTH IN FEET	SAMPLE NO.	LITHOLOGY	GROUNDWATER	SOIL CLASS (USCS)	BORING SB 4		PENETRATION RESISTANCE (BLOWS/FT.)	DRY DENSITY (P.C.F.)	MOISTURE CONTENT (%)
					ELEV. (MSL.) <u>307'</u>	DATE COMPLETED <u>07-19-2017</u>			
					EQUIPMENT <u>CME 75</u>		BY: <u>N. BORJA</u>		
MATERIAL DESCRIPTION									
0				SM	UNDOCUMENTED FILL (Qudf) Medium dense, moist, tan brown, Silty, fine to medium SAND; few gravel				
2									
4									
6									
8				SC	COMPACTED FILL (Qcf) Medium dense to dense, moist, brown, Clayey, fine to medium SAND; little gravel				
10	SB4-1						69	121.4	10.4
12									
14				SM	Dense, moist, grayish brown to brown, Silty, fine to medium SAND; few gravel				
16				CL	Hard, moist, brown, Sandy CLAY; trace gravel				
18									
20	SB4-2						50	116.3	11.4
22									
24									
26				SC	Dense, moist, brown to olive brown, Clayey, fine to medium SAND; few gravel				
28									

Figure A-90,
Log of Boring SB 4, Page 1 of 3

G2070-42-02.GPJ

SAMPLE SYMBOLS					
	... SAMPLING UNSUCCESSFUL		... STANDARD PENETRATION TEST		... DRIVE SAMPLE (UNDISTURBED)
	... DISTURBED OR BAG SAMPLE		... CHUNK SAMPLE		... WATER TABLE OR SEEPAGE

NOTE: THE LOG OF SUBSURFACE CONDITIONS SHOWN HEREON APPLIES ONLY AT THE SPECIFIC BORING OR TRENCH LOCATION AND AT THE DATE INDICATED. IT IS NOT WARRANTED TO BE REPRESENTATIVE OF SUBSURFACE CONDITIONS AT OTHER LOCATIONS AND TIMES.

DEPTH IN FEET	SAMPLE NO.	LITHOLOGY	GROUNDWATER	SOIL CLASS (USCS)	BORING SB 4		PENETRATION RESISTANCE (BLOWS/FT.)	DRY DENSITY (P.C.F.)	MOISTURE CONTENT (%)
					ELEV. (MSL.) <u>307'</u>	DATE COMPLETED <u>07-19-2017</u>			
					EQUIPMENT <u>CME 75</u> BY: <u>N. BORJA</u>				
					MATERIAL DESCRIPTION				
30	SB4-3			SC	-Excavates with little gravel		57	110.2	10.9
32									
34				CL	Very stiff, moist, brown, Sandy CLAY				
36									
38				SM	Dense to very dense, moist, brown, Silty, fine to medium SAND; little gravel				
40	SB4-4						67/11"	125.6	8.2
42									
44									
46									
48									
50	SB4-5				-Poor recovery		50/5"		
52									
54									
56									
58									

Figure A-90,
Log of Boring SB 4, Page 2 of 3

G2070-42-02.GPJ







SAMPLE SYMBOLS		... SAMPLING UNSUCCESSFUL		... STANDARD PENETRATION TEST		... DRIVE SAMPLE (UNDISTURBED)
		... DISTURBED OR BAG SAMPLE		... CHUNK SAMPLE		... WATER TABLE OR SEEPAGE

NOTE: THE LOG OF SUBSURFACE CONDITIONS SHOWN HEREON APPLIES ONLY AT THE SPECIFIC BORING OR TRENCH LOCATION AND AT THE DATE INDICATED. IT IS NOT WARRANTED TO BE REPRESENTATIVE OF SUBSURFACE CONDITIONS AT OTHER LOCATIONS AND TIMES.

DEPTH IN FEET	SAMPLE NO.	LITHOLOGY	GROUNDWATER	SOIL CLASS (USCS)	BORING SB 4		PENETRATION RESISTANCE (BLOWS/FT.)	DRY DENSITY (P.C.F.)	MOISTURE CONTENT (%)
					ELEV. (MSL.) <u>307'</u>	DATE COMPLETED <u>07-19-2017</u>			
					EQUIPMENT <u>CME 75</u>		BY: <u>N. BORJA</u>		
MATERIAL DESCRIPTION									
60				SM					
62									
64									
66									
68				SC	Dense, moist to wet, brown, Clayey, fine to coarse SAND; little gravel				
70	SB4-6						49	111.4	10.8
72									
74									
76									
78									
80	SB4-7		▼		-No recovery at 80 feet due to groundwater		22		
82									
84									
86				GM	STADIUM CONGLOMERATE (Tst) Very dense, saturated, brown, fine to coarse, Sandy CONGLOMERATE				
88	SB4-8						50/2"		
BORING TERMINATED AT 88 FEET Groundwater encountered at 80 feet									

Figure A-90,
Log of Boring SB 4, Page 3 of 3

G2070-42-02.GPJ







SAMPLE SYMBOLS	 ... SAMPLING UNSUCCESSFUL	 ... STANDARD PENETRATION TEST	 ... DRIVE SAMPLE (UNDISTURBED)
	 ... DISTURBED OR BAG SAMPLE	 ... CHUNK SAMPLE	 ... WATER TABLE OR SEEPAGE

NOTE: THE LOG OF SUBSURFACE CONDITIONS SHOWN HEREON APPLIES ONLY AT THE SPECIFIC BORING OR TRENCH LOCATION AND AT THE DATE INDICATED. IT IS NOT WARRANTED TO BE REPRESENTATIVE OF SUBSURFACE CONDITIONS AT OTHER LOCATIONS AND TIMES.

DEPTH IN FEET	SAMPLE NO.	LITHOLOGY	GROUNDWATER	SOIL CLASS (USCS)	BORING SB 5		PENETRATION RESISTANCE (BLOWS/FT.)	DRY DENSITY (P.C.F.)	MOISTURE CONTENT (%)
					ELEV. (MSL.) <u>325'</u>	DATE COMPLETED <u>10-30-2017</u>			
					EQUIPMENT <u>CME 95</u>		BY: <u>N. BORJA</u>		
MATERIAL DESCRIPTION									
0				SM	UNDOCUMENTED FILL (Qudf) Loose to medium dense, damp, dark brown, Silty, fine to coarse SAND; little gravel				
2									
4									
6	SB5-1			SM	COMPACTED FILL (Qcf) Dense, moist, light grayish brown, Silty, fine to coarse SAND; little gravel		61	123.2	12.0
8									
10	SB5-2				-Becomes medium dense and dark yellowish brown below 10 feet		40		
12									
14									
16	SB5-3						34	116.3	12.0
18									
20	SB5-4						44		
22									
24				SC	Medium dense, moist, olive brown, Clayey, fine to medium SAND; few gravel				
26	SB5-5						42	117.3	11.5
28									

Figure A-91,
Log of Boring SB 5, Page 1 of 4

G2070-42-02.GPJ

SAMPLE SYMBOLS	 ... SAMPLING UNSUCCESSFUL	 ... STANDARD PENETRATION TEST	 ... DRIVE SAMPLE (UNDISTURBED)
	 ... DISTURBED OR BAG SAMPLE	 ... CHUNK SAMPLE	 ... WATER TABLE OR SEEPAGE

NOTE: THE LOG OF SUBSURFACE CONDITIONS SHOWN HEREON APPLIES ONLY AT THE SPECIFIC BORING OR TRENCH LOCATION AND AT THE DATE INDICATED. IT IS NOT WARRANTED TO BE REPRESENTATIVE OF SUBSURFACE CONDITIONS AT OTHER LOCATIONS AND TIMES.

DEPTH IN FEET	SAMPLE NO.	LITHOLOGY	GROUNDWATER	SOIL CLASS (USCS)	BORING SB 5		PENETRATION RESISTANCE (BLOWS/FT.)	DRY DENSITY (P.C.F.)	MOISTURE CONTENT (%)	
					ELEV. (MSL.) <u>325'</u>	DATE COMPLETED <u>10-30-2017</u>				
					EQUIPMENT <u>CME 95</u>		BY: <u>N. BORJA</u>			
MATERIAL DESCRIPTION										
30	SB5-6			CL	-Excavates with pocket of gray, Sandy CLAY		21			
32						-Excavates with little gravel; trace cobble				
34										
36	SB5-7					-No recovery due to rock		50/3"		
38										
40	SB5-8					-No recovery		50/5"		
42										
44										
46	SB5-9				CL SM	Hard, moist, dark gray, Sandy CLAY; few gravel and cobble Dense, damp, yellowish brown, Silty, fine to medium SAND; little gravel and cobble		55		
48										
50	SB5-10					*Used SPT to break up rock		62		
52										
54										
56	SB5-11				-Blow count may not be accurate due to rock in shoe		50/6"	120.0	7.9	
58										

Figure A-91,
Log of Boring SB 5, Page 2 of 4

G2070-42-02.GPJ

SAMPLE SYMBOLS		... SAMPLING UNSUCCESSFUL		... STANDARD PENETRATION TEST		... DRIVE SAMPLE (UNDISTURBED)
		... DISTURBED OR BAG SAMPLE		... CHUNK SAMPLE		... WATER TABLE OR SEEPAGE

NOTE: THE LOG OF SUBSURFACE CONDITIONS SHOWN HEREON APPLIES ONLY AT THE SPECIFIC BORING OR TRENCH LOCATION AND AT THE DATE INDICATED. IT IS NOT WARRANTED TO BE REPRESENTATIVE OF SUBSURFACE CONDITIONS AT OTHER LOCATIONS AND TIMES.

DEPTH IN FEET	SAMPLE NO.	LITHOLOGY	GROUNDWATER	SOIL CLASS (USCS)	BORING SB 5		PENETRATION RESISTANCE (BLOWS/FT.)	DRY DENSITY (P.C.F.)	MOISTURE CONTENT (%)
					ELEV. (MSL.) <u>325'</u>	DATE COMPLETED <u>10-30-2017</u>			
					EQUIPMENT <u>CME 95</u> BY: <u>N. BORJA</u>				
MATERIAL DESCRIPTION									
60	SB5-12			SM	-Disturbed sample		85/11"		
62									
64				SM	Very dense, moist, olive brown and light brown, Silty, fine to medium SAND; few gravel and cobble				
66	SB5-13						50/5"	115.7	12.1
68									
70	SB5-14				-Becomes brown below 70 feet		40		
72									
74									
76	SB5-15						65	122.1	8.8
78									
80	SB5-16						80/11"		
82									
84				SC	Dense, moist, brown, Clayey, fine to medium SAND; few gravel				
86	SB5-17						52	115.9	8.8
88									

Figure A-91,
Log of Boring SB 5, Page 3 of 4

G2070-42-02.GPJ

SAMPLE SYMBOLS		
	... DISTURBED OR BAG SAMPLE	
	... SAMPLING UNSUCCESSFUL	
	... CHUNK SAMPLE	

NOTE: THE LOG OF SUBSURFACE CONDITIONS SHOWN HEREON APPLIES ONLY AT THE SPECIFIC BORING OR TRENCH LOCATION AND AT THE DATE INDICATED. IT IS NOT WARRANTED TO BE REPRESENTATIVE OF SUBSURFACE CONDITIONS AT OTHER LOCATIONS AND TIMES.

DEPTH IN FEET	SAMPLE NO.	LITHOLOGY	GROUNDWATER	SOIL CLASS (USCS)	BORING SB 5		PENETRATION RESISTANCE (BLOWS/FT.)	DRY DENSITY (P.C.F.)	MOISTURE CONTENT (%)
					ELEV. (MSL.) <u>325'</u>	DATE COMPLETED <u>10-30-2017</u>			
					EQUIPMENT <u>CME 95</u> BY: <u>N. BORJA</u>				
MATERIAL DESCRIPTION									
90	SB5-18			SC			60		
92									
94				SM	Dense, moist, brown, Silty, fine to medium SAND; few gravel				
96	SB5-19						79	118.7	12.5
98									
100	SB5-20			SM&SC	Dense, moist, brown, Silty to Clayey, fine to medium SAND; few gravel				
102			▼		-Groundwater at 102 feet				
104									
106	SB5-21			GM	-Disturbed sample; poor recovery STADIUM CONGLOMERATE (Tst) Very dense, saturated, yellowish brown to brown, Sandy CONGLOMERATE		50/3"		
108									
110	SB5-22				-Poor recovery		50/4"		
BORING TERMINATED AT 110.5 FEET									

Figure A-91,
Log of Boring SB 5, Page 4 of 4

G2070-42-02.GPJ

SAMPLE SYMBOLS			
	... SAMPLING UNSUCCESSFUL		... STANDARD PENETRATION TEST
	... DISTURBED OR BAG SAMPLE		... DRIVE SAMPLE (UNDISTURBED)
	... CHUNK SAMPLE	▼	... WATER TABLE OR SEEPAGE

NOTE: THE LOG OF SUBSURFACE CONDITIONS SHOWN HEREON APPLIES ONLY AT THE SPECIFIC BORING OR TRENCH LOCATION AND AT THE DATE INDICATED. IT IS NOT WARRANTED TO BE REPRESENTATIVE OF SUBSURFACE CONDITIONS AT OTHER LOCATIONS AND TIMES.









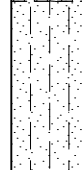
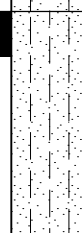
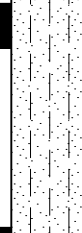
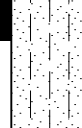
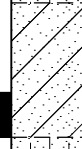
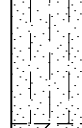

DEPTH IN FEET	SAMPLE NO.	LITHOLOGY	GROUNDWATER	SOIL CLASS (USCS)	BORING SB 6		PENETRATION RESISTANCE (BLOWS/FT.)	DRY DENSITY (P.C.F.)	MOISTURE CONTENT (%)
					ELEV. (MSL.) <u>306'</u>	DATE COMPLETED <u>10-30-2017</u>			
					EQUIPMENT <u>CME 95</u> BY: <u>N. BORJA</u>				
MATERIAL DESCRIPTION									
0				GP	UNDOCUMENTED FILL (Qudf) 3/4" - 1" GRAVEL				
2				SM	Loose to medium, moist, light brown, Silty, fine to coarse SAND; few clay; few gravel				
6	SB6-1			SM	COMPACTED FILL (Qcf) Medium dense, moist, light brown, Silty, fine to coarse SAND; few gravel and some clay	39	104.3	8.4	
10	SB6-2				-Becomes damp and dark brown; decrease in clay content below 10 feet	45			
16	SB6-3					63	119.2	8.5	
18				CL	Hard, damp, dark reddish brown, Sandy CLAY; little gravel; few cobble				
20	SB6-4			SM	Dense, damp to moist, light brown, Silty, fine to coarse SAND; few clay; few gravel and cobble	89			
24				CL	Stiff, moist, mottled dark reddish brown and brown, Sandy CLAY; little gravel and cobble				
26	SB6-5			SM	Medium dense, moist, light brown and brown, Silty, fine to coarse SAND;	35	106.3	9.7	
28				SM					

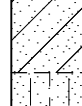
Figure A-92,
Log of Boring SB 6, Page 1 of 4

G2070-42-02.GPJ

SAMPLE SYMBOLS		... SAMPLING UNSUCCESSFUL		... STANDARD PENETRATION TEST		... DRIVE SAMPLE (UNDISTURBED)
		... DISTURBED OR BAG SAMPLE		... CHUNK SAMPLE		... WATER TABLE OR SEEPAGE

NOTE: THE LOG OF SUBSURFACE CONDITIONS SHOWN HEREON APPLIES ONLY AT THE SPECIFIC BORING OR TRENCH LOCATION AND AT THE DATE INDICATED. IT IS NOT WARRANTED TO BE REPRESENTATIVE OF SUBSURFACE CONDITIONS AT OTHER LOCATIONS AND TIMES.

DEPTH IN FEET	SAMPLE NO.	LITHOLOGY	GROUNDWATER	SOIL CLASS (USCS)	BORING SB 6		PENETRATION RESISTANCE (BLOWS/FT.)	DRY DENSITY (P.C.F.)	MOISTURE CONTENT (%)
					ELEV. (MSL.) <u>306'</u>	DATE COMPLETED <u>10-30-2017</u>			
					EQUIPMENT <u>CME 95</u> BY: <u>N. BORJA</u>				
					MATERIAL DESCRIPTION				
30	SB6-6			SM	few gravel and cobble		38	123.2	10.1
32									
34				SC	Medium dense, moist, light brown, Clayey, fine to medium SAND; few gravel				
36	SB6-7						37	112.7	11.4
38									
40	SB6-8			SM	Very dense, moist, brown, Silty, fine to coarse SAND; few gravel		73		
42									
44									
46	SB6-9						75/11"	114.3	9.7
48									
50	SB6-10						96		
52									
54									
56	SB6-11				-Becomes damp and light brown below 55 feet		61	118.9	8.2
58									

Figure A-92,
Log of Boring SB 6, Page 2 of 4

G2070-42-02.GPJ

SAMPLE SYMBOLS		... SAMPLING UNSUCCESSFUL		... STANDARD PENETRATION TEST		... DRIVE SAMPLE (UNDISTURBED)
		... DISTURBED OR BAG SAMPLE		... CHUNK SAMPLE		... WATER TABLE OR SEEPAGE

NOTE: THE LOG OF SUBSURFACE CONDITIONS SHOWN HEREON APPLIES ONLY AT THE SPECIFIC BORING OR TRENCH LOCATION AND AT THE DATE INDICATED. IT IS NOT WARRANTED TO BE REPRESENTATIVE OF SUBSURFACE CONDITIONS AT OTHER LOCATIONS AND TIMES.

DEPTH IN FEET	SAMPLE NO.	LITHOLOGY	GROUNDWATER	SOIL CLASS (USCS)	BORING SB 6		PENETRATION RESISTANCE (BLOWS/FT.)	DRY DENSITY (P.C.F.)	MOISTURE CONTENT (%)
					ELEV. (MSL.) <u>306'</u>	DATE COMPLETED <u>10-30-2017</u>			
					EQUIPMENT <u>CME 95</u>	BY: <u>N. BORJA</u>			
MATERIAL DESCRIPTION									
60	SB6-12			SM			50		
62									
64									
66	SB6-13		91/10"	114.5			11.2		
68									
70	SB6-14		SM&SC	Dense, moist, brown to olive brown, Silty to Clayey, fine to medium SAND; few gravel and cobble	66				
72									
74									
76	SB6-15			SC&CL	Medium dense, moist, olive brown, Clayey, fine to coarse SAND to Sandy CLAY; few gravel and cobble	36	115.3	14.8	
78									
80	SB6-16		40	116.1	13.6				
82									
84				GM	STADIUM CONGLOMERATE (Tst) Very dense, moist, yellowish brown to brown, Sandy CONGLOMERATE				
86	SB6-17				-Hard drilling below 85 feet; no recovery	50/3"			
88									

Figure A-92,
Log of Boring SB 6, Page 3 of 4

G2070-42-02.GPJ

SAMPLE SYMBOLS		... SAMPLING UNSUCCESSFUL		... STANDARD PENETRATION TEST		... DRIVE SAMPLE (UNDISTURBED)
		... DISTURBED OR BAG SAMPLE		... CHUNK SAMPLE		... WATER TABLE OR SEEPAGE

NOTE: THE LOG OF SUBSURFACE CONDITIONS SHOWN HEREON APPLIES ONLY AT THE SPECIFIC BORING OR TRENCH LOCATION AND AT THE DATE INDICATED. IT IS NOT WARRANTED TO BE REPRESENTATIVE OF SUBSURFACE CONDITIONS AT OTHER LOCATIONS AND TIMES.

DEPTH IN FEET	SAMPLE NO.	LITHOLOGY	GROUNDWATER	SOIL CLASS (USCS)	BORING SB 7		PENETRATION RESISTANCE (BLOWS/FT.)	DRY DENSITY (P.C.F.)	MOISTURE CONTENT (%)
					ELEV. (MSL.) <u>300'</u>	DATE COMPLETED <u>10-31-2017 TO 11-01-2017</u>			
					EQUIPMENT <u>CME 95</u>		BY: <u>N. BORJA</u>		
MATERIAL DESCRIPTION									
0				SM	UNDOCUMENTED FILL (Qudf) Loose to medium dense, dry to damp, yellowish brown to brown, Silty, fine to medium SAND; few gravel				
2									
4									
6	SB7-1			SM&SC	COMPACTED FILL (Qcf) Medium dense to dense, moist, dark brown, Silty to Clayey, fine to coarse SAND; few gravel		45	109.9	7.5
8									
10	SB7-2				-Becomes dense at 10 feet		54	111.5	8.4
12									
14				SM	Medium dense, moist, brown, Silty, fine coarse SAND; few gravel				
16	SB7-3						30	104.1	8.9
18									
20	SB7-4				-Excavates with few clay below 20 feet		33		
22									
24				SC	Medium dense, moist, brown, Clayey, fine to medium SAND; little gravel				
26	SB7-5						44	114.3	10.6
28									

Figure A-93,
Log of Boring SB 7, Page 1 of 3

G2070-42-02.GPJ

SAMPLE SYMBOLS		... SAMPLING UNSUCCESSFUL		... STANDARD PENETRATION TEST		... DRIVE SAMPLE (UNDISTURBED)
		... DISTURBED OR BAG SAMPLE		... CHUNK SAMPLE		... WATER TABLE OR SEEPAGE

NOTE: THE LOG OF SUBSURFACE CONDITIONS SHOWN HEREON APPLIES ONLY AT THE SPECIFIC BORING OR TRENCH LOCATION AND AT THE DATE INDICATED. IT IS NOT WARRANTED TO BE REPRESENTATIVE OF SUBSURFACE CONDITIONS AT OTHER LOCATIONS AND TIMES.

DEPTH IN FEET	SAMPLE NO.	LITHOLOGY	GROUNDWATER	SOIL CLASS (USCS)	BORING SB 7		PENETRATION RESISTANCE (BLOWS/FT.)	DRY DENSITY (P.C.F.)	MOISTURE CONTENT (%)
					ELEV. (MSL.) <u>300'</u>	DATE COMPLETED <u>10-31-2017 TO 11-01-2017</u>			
					EQUIPMENT <u>CME 95</u>		BY: <u>N. BORJA</u>		
MATERIAL DESCRIPTION									
30	SB7-6			SC SM	Very dense, moist, brown, Silty, fine to medium SAND; little gravel -Becomes dense -Becomes medium dense -Becomes very dense	72			
32									
34									
36	SB7-7					47	119.6	7.9	
38									
40	SB7-8					21			
42									
44									
46	SB7-9				28	112.6	15.0		
48									
50	SB7-10				85/9"				
52									
54				CL	Hard, moist to wet, brown to olive brown, Sandy CLAY; few gravel and cobble				
56	SB7-11					74	118.3	13.4	
58									

Figure A-93,
Log of Boring SB 7, Page 2 of 3

G2070-42-02.GPJ

SAMPLE SYMBOLS		... SAMPLING UNSUCCESSFUL		... STANDARD PENETRATION TEST		... DRIVE SAMPLE (UNDISTURBED)
		... DISTURBED OR BAG SAMPLE		... CHUNK SAMPLE		... WATER TABLE OR SEEPAGE

NOTE: THE LOG OF SUBSURFACE CONDITIONS SHOWN HEREON APPLIES ONLY AT THE SPECIFIC BORING OR TRENCH LOCATION AND AT THE DATE INDICATED. IT IS NOT WARRANTED TO BE REPRESENTATIVE OF SUBSURFACE CONDITIONS AT OTHER LOCATIONS AND TIMES.

DEPTH IN FEET	SAMPLE NO.	LITHOLOGY	GROUNDWATER	SOIL CLASS (USCS)	BORING SB 7		PENETRATION RESISTANCE (BLOWS/FT.)	DRY DENSITY (P.C.F.)	MOISTURE CONTENT (%)
					ELEV. (MSL.) 300'	DATE COMPLETED 10-31-2017 TO 11-01-2017			
					EQUIPMENT CME 95 BY: N. BORJA				
MATERIAL DESCRIPTION									
60	SB7-12			CL SC	Very dense, moist, brown to olive brown, Clayey, fine to medium SAND; few gravel and cobble		74		
62									
64				SM	Very dense, moist, brown, Silty, fine to coarse SAND; little gravel				
66	SB7-13		▼	GM	-Groundwater at 65 feet STADIUM CONGLOMERATE (Tst) Very dense, moist to wet, mottled brown and yellowish brown, Sandy CONGLOMERATE		77/9"	106.9	11.6
68									
70	SB7-14			SM	Very dense, wet, mottled light gray, reddish brown and yellowish brown, Silty, fine- to coarse-grained SANDSTONE		50/6"		
BORING TERMINATED AT 70.5 FEET									

Figure A-93,
Log of Boring SB 7, Page 3 of 3

G2070-42-02.GPJ







SAMPLE SYMBOLS		... SAMPLING UNSUCCESSFUL		... STANDARD PENETRATION TEST		... DRIVE SAMPLE (UNDISTURBED)
		... DISTURBED OR BAG SAMPLE		... CHUNK SAMPLE		... WATER TABLE OR SEEPAGE

NOTE: THE LOG OF SUBSURFACE CONDITIONS SHOWN HEREON APPLIES ONLY AT THE SPECIFIC BORING OR TRENCH LOCATION AND AT THE DATE INDICATED. IT IS NOT WARRANTED TO BE REPRESENTATIVE OF SUBSURFACE CONDITIONS AT OTHER LOCATIONS AND TIMES.

DEPTH IN FEET	SAMPLE NO.	LITHOLOGY	GROUNDWATER	SOIL CLASS (USCS)	BORING SB 8		PENETRATION RESISTANCE (BLOWS/FT.)	DRY DENSITY (P.C.F.)	MOISTURE CONTENT (%)
					ELEV. (MSL.) <u>314'</u>	DATE COMPLETED <u>11-01-2017</u>			
					EQUIPMENT <u>CME 95</u>		BY: <u>N. BORJA</u>		
MATERIAL DESCRIPTION									
0				SM	UNDOCUMENTED FILL (Qudf) Loose to medium dense, dry, light yellowish brown, Silty, fine to medium SAND; little gravel and cobble -Becomes medium dense, moist; few clay				
2									
4									
6	SB8-1			SM	COMPACTED FILL (Qcf) Medium dense, moist, brown to olive brown, Silty, fine to medium SAND; little gravel and cobble		47	124.6	10.4
8									
10	SB8-2				-Becomes dense and brown below 10 feet		59	121.6	9.0
12									
14				SC	Dense, moist, brown, Clayey, fine to medium SAND; little gravel and cobble				
16	SB8-3				-Blow count not accurate due to rock; poor recovery		50/2"		
18				SM	Dense, moist, brown, Silty, fine to medium SAND; little gravel and cobble				
20	SB8-4						48	108.4	7.7
22									
24				SC	Medium dense, moist, brown, Clayey, fine to medium SAND; few gravel and cobble				
26	SB8-5						34		
28									

Figure A-94,
Log of Boring SB 8, Page 1 of 4

G2070-42-02.GPJ

SAMPLE SYMBOLS			
	... SAMPLING UNSUCCESSFUL		... STANDARD PENETRATION TEST
	... DRIVE SAMPLE (UNDISTURBED)		... DISTURBED OR BAG SAMPLE
	... CHUNK SAMPLE		... WATER TABLE OR SEEPAGE

NOTE: THE LOG OF SUBSURFACE CONDITIONS SHOWN HEREON APPLIES ONLY AT THE SPECIFIC BORING OR TRENCH LOCATION AND AT THE DATE INDICATED. IT IS NOT WARRANTED TO BE REPRESENTATIVE OF SUBSURFACE CONDITIONS AT OTHER LOCATIONS AND TIMES.

DEPTH IN FEET	SAMPLE NO.	LITHOLOGY	GROUNDWATER	SOIL CLASS (USCS)	BORING SB 8		PENETRATION RESISTANCE (BLOWS/FT.)	DRY DENSITY (P.C.F.)	MOISTURE CONTENT (%)
					ELEV. (MSL.) <u>314'</u>	DATE COMPLETED <u>11-01-2017</u>			
					EQUIPMENT <u>CME 95</u> BY: <u>N. BORJA</u>				
					MATERIAL DESCRIPTION				
30	SB8-6			SC SM	Dense, moist, brown to olive brown, Silty, fine to coarse SAND; few gravel		51	114.7	11.5
32									
34					-Becomes medium dense; little gravel				
36	SB8-7						39		
38									
40	SB8-8						26	107.2	7.4
42									
44									
46	SB8-9						46		
48									
50	SB8-10				-Becomes dense		72	116.9	7.4
52									
54									
56	SB8-11						65		
58									

Figure A-94,
Log of Boring SB 8, Page 2 of 4

G2070-42-02.GPJ

SAMPLE SYMBOLS	... SAMPLING UNSUCCESSFUL	... STANDARD PENETRATION TEST	... DRIVE SAMPLE (UNDISTURBED)
	... DISTURBED OR BAG SAMPLE	... CHUNK SAMPLE	... WATER TABLE OR SEEPAGE

NOTE: THE LOG OF SUBSURFACE CONDITIONS SHOWN HEREON APPLIES ONLY AT THE SPECIFIC BORING OR TRENCH LOCATION AND AT THE DATE INDICATED. IT IS NOT WARRANTED TO BE REPRESENTATIVE OF SUBSURFACE CONDITIONS AT OTHER LOCATIONS AND TIMES.

DEPTH IN FEET	SAMPLE NO.	LITHOLOGY	GROUNDWATER	SOIL CLASS (USCS)	BORING SB 8		PENETRATION RESISTANCE (BLOWS/FT.)	DRY DENSITY (P.C.F.)	MOISTURE CONTENT (%)
					ELEV. (MSL.) <u>314'</u>	DATE COMPLETED <u>11-01-2017</u>			
					EQUIPMENT <u>CME 95</u>		BY: <u>N. BORJA</u>		
MATERIAL DESCRIPTION									
60	SB8-12			SM			51	113.4	13.9
62									
64				SC	Dense, moist, brown, Clayey, fine to coarse SAND; few gravel		63		
66	SB8-13								
68									
70	SB8-14			SM	Medium dense, moist to wet, brown, Silty, fine to coarse SAND; few gravel		29	110.7	14.7
72									
74				SC	Medium dense, moist, brown to olive brown, Clayey, fine to coarse SAND; few gravel and cobble; few asphalt chunks		38		
76	SB8-15								
78									
80	SB8-16				-Blow count not accurate due to rock in sampler		93/9"	128.6	10.2
82									
84				SM	Medium dense, moist to wet, olive brown, Silty, fine to coarse SAND; little gravel and cobble		43		
86	SB8-17				-Groundwater at 85 feet				
88				GM	STADIUM CONGLOMERATE (Tst) Very dense, saturated, brown to yellowish brown, Silty, fine to coarse CONGLOMERATE				

Figure A-94,
Log of Boring SB 8, Page 3 of 4

G2070-42-02.GPJ







SAMPLE SYMBOLS			
	... SAMPLING UNSUCCESSFUL		... STANDARD PENETRATION TEST
	... DISTURBED OR BAG SAMPLE		... DRIVE SAMPLE (UNDISTURBED)
	... CHUNK SAMPLE		... WATER TABLE OR SEEPAGE

NOTE: THE LOG OF SUBSURFACE CONDITIONS SHOWN HEREON APPLIES ONLY AT THE SPECIFIC BORING OR TRENCH LOCATION AND AT THE DATE INDICATED. IT IS NOT WARRANTED TO BE REPRESENTATIVE OF SUBSURFACE CONDITIONS AT OTHER LOCATIONS AND TIMES.

DEPTH IN FEET	SAMPLE NO.	LITHOLOGY	GROUNDWATER	SOIL CLASS (USCS)	BORING SB 8		PENETRATION RESISTANCE (BLOWS/FT.)	DRY DENSITY (P.C.F.)	MOISTURE CONTENT (%)		
					ELEV. (MSL.) <u>314'</u>	DATE COMPLETED <u>11-01-2017</u>					
					EQUIPMENT <u>CME 95</u> BY: <u>N. BORJA</u>						
					MATERIAL DESCRIPTION						
90	SB8-18	GM		GM	BORING TERMINATED AT 90.5 FEET				50/1"	116.8	15.2

Figure A-94,
Log of Boring SB 8, Page 4 of 4

G2070-42-02.GPJ

SAMPLE SYMBOLS	 ... SAMPLING UNSUCCESSFUL	 ... STANDARD PENETRATION TEST	 ... DRIVE SAMPLE (UNDISTURBED)
	 ... DISTURBED OR BAG SAMPLE	 ... CHUNK SAMPLE	 ... WATER TABLE OR SEEPAGE

NOTE: THE LOG OF SUBSURFACE CONDITIONS SHOWN HEREON APPLIES ONLY AT THE SPECIFIC BORING OR TRENCH LOCATION AND AT THE DATE INDICATED. IT IS NOT WARRANTED TO BE REPRESENTATIVE OF SUBSURFACE CONDITIONS AT OTHER LOCATIONS AND TIMES.

APPENDIX

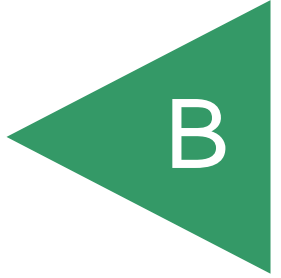

APPENDIX B

LABORATORY TESTING

We performed laboratory tests in accordance with generally accepted test methods of the American Society for Testing and Materials (ASTM) or other suggested procedures. We tested selected samples for in-place dry density and moisture content, maximum dry density and optimum moisture content, expansion index, shear strength, water-soluble sulfate characteristics, chloride concentration, pH and resistivity, and consolidation characteristics. The results of our laboratory tests are presented in the following tables and graphs. The in-place dry density and moisture content test results are presented on the exploratory boring logs in Appendix A.

**TABLE B-I
SUMMARY OF LABORATORY MAXIMUM DRY DENSITY AND
OPTIMUM MOISTURE CONTENT TEST RESULTS
ASTM D 1557**

Proctor Curve No.	Source and Description	Maximum Dry Density (pcf)	Optimum Moisture Content (%)
T16-1	Dark brown, Silty SAND with some gravel	135.3	7.6
T19-2	Dark brown, fine to coarse, Sandy GRAVEL with little clay	131.7	8.2
T29-1	Dark brown, Clayey, fine to coarse SAND	128.4	9.5
LB11-2	Yellowish brown, Gravelly, fine to medium SAND	132.6	8.3
LB16-2	Yellowish brown, Gravelly, fine to medium SAND	131.9	8.4

**TABLE B-II
SUMMARY OF LABORATORY EXPANSION INDEX TEST RESULTS
ASTM D 4829**

Sample No.	Moisture Content (%)		Dry Density (pcf)	Expansion Index	Expansion Classification
	Before Test	After Test			
T5-1	10.0	22.2	107.8	45	Low
T9-2	9.2	16.7	113.8	3	Very Low
T16-1	8.5	15.0	114.2	4	Very Low
T19-2	9.7	16.4	111.1	1	Very Low
T29-1	10.0	20.8	109.3	47	Low
T34-1	8.8	15.0	113.8	3	Very Low

**TABLE B-III
SUMMARY OF LABORATORY DIRECT SHEAR TEST RESULTS
ASTM D 3080**

Sample No.	Dry Density (pcf)	Moisture Content (%)		Unit Cohesion (psf)	Angle of Shear Resistance-Ultimate (degrees)
		Initial	Final		
SB1-3	117.0	13.4	14.1	975	34
SB3-3	118.4	11.1	13.1	540	38
T16-1*	122.0	7.2	12.7	650	32
T29-1*	114.5	10.4	17.2	700	26
LB11-2*	119.3	8.3	14.9	660	30
LB16-2*	118.2	8.4	15.9	445	32

*Samples remolded to approximately 90 percent relative compaction near optimum moisture content.

**TABLE B-IV
SUMMARY OF LABORATORY WATER-SOLUBLE SULFATE CALIFORNIA TEST NO. 417**

Sample No.	Water-Soluble Sulfate (%)	Classification
T5-1	0.040	Negligible (S0)
T9-2	0.0003	Negligible (S0)
T16-1	0.025	Negligible (S0)
T19-2	0.015	Negligible (S0)
T29-1	0.022	Negligible (S0)
T34-1	0.001	Negligible (S0)

**TABLE B-V
SUMMARY OF LABORATORY CHLORIDE ION CONTENT TEST RESULTS
AASHTO T 291**

Sample No.	Chloride Ion Content (ppm)	Chloride Ion Content (%)
T5-1	1511	0.151
T29-1	520	0.052
T34-1	395	0.040

**TABLE B-VI
SUMMARY OF LABORATORY POTENTIAL OF HYDROGEN (PH) AND RESISTIVITY TEST RESULTS
CALIFORNIA TEST NO. 417**

Sample No.	pH	Resistivity (ohm-cm)
T5-1	7.4	300
T29-1	6.7	950

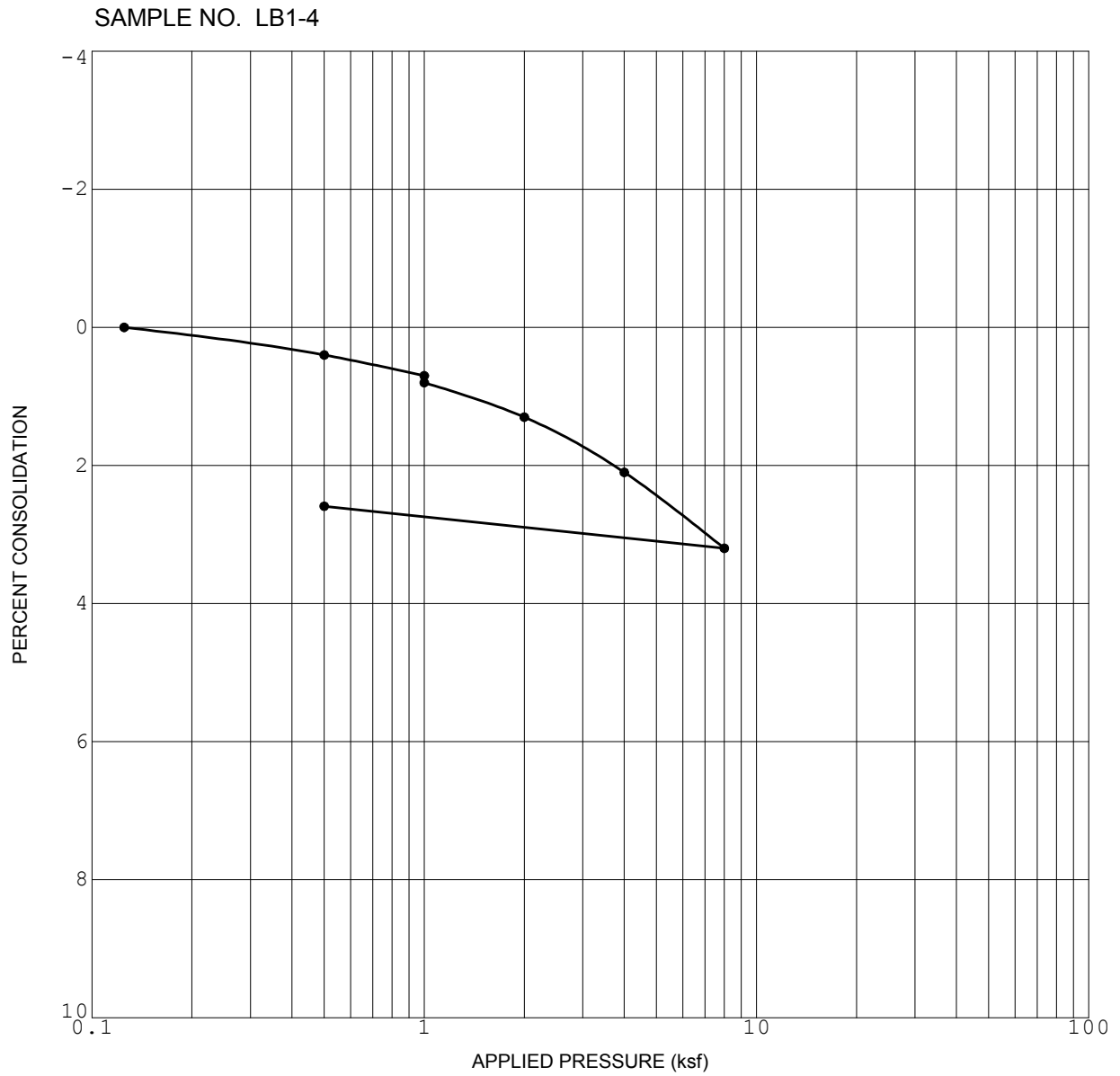

Initial Dry Density (pcf)	124.9
Initial Water Content (%)	9.5

Initial Saturation (%)	76.6
Sample Saturated at (ksf)	1.0

CONSOLIDATION CURVE

3ROOTS

SAN DIEGO, CALIFORNIA

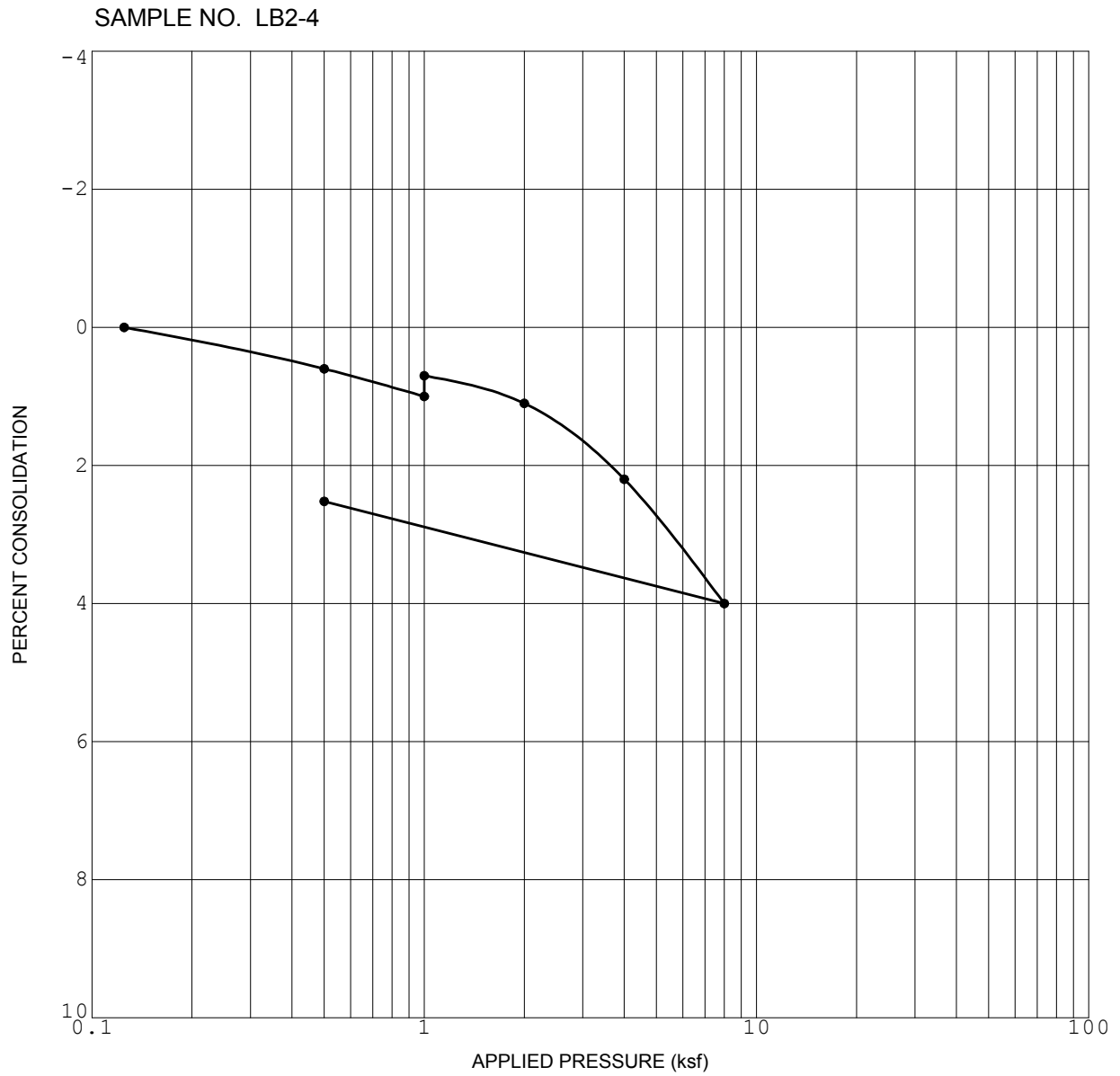

Initial Dry Density (pcf)	108.1
Initial Water Content (%)	14.7

Initial Saturation (%)	72.9
Sample Saturated at (ksf)	1.0

CONSOLIDATION CURVE

3ROOTS

SAN DIEGO, CALIFORNIA

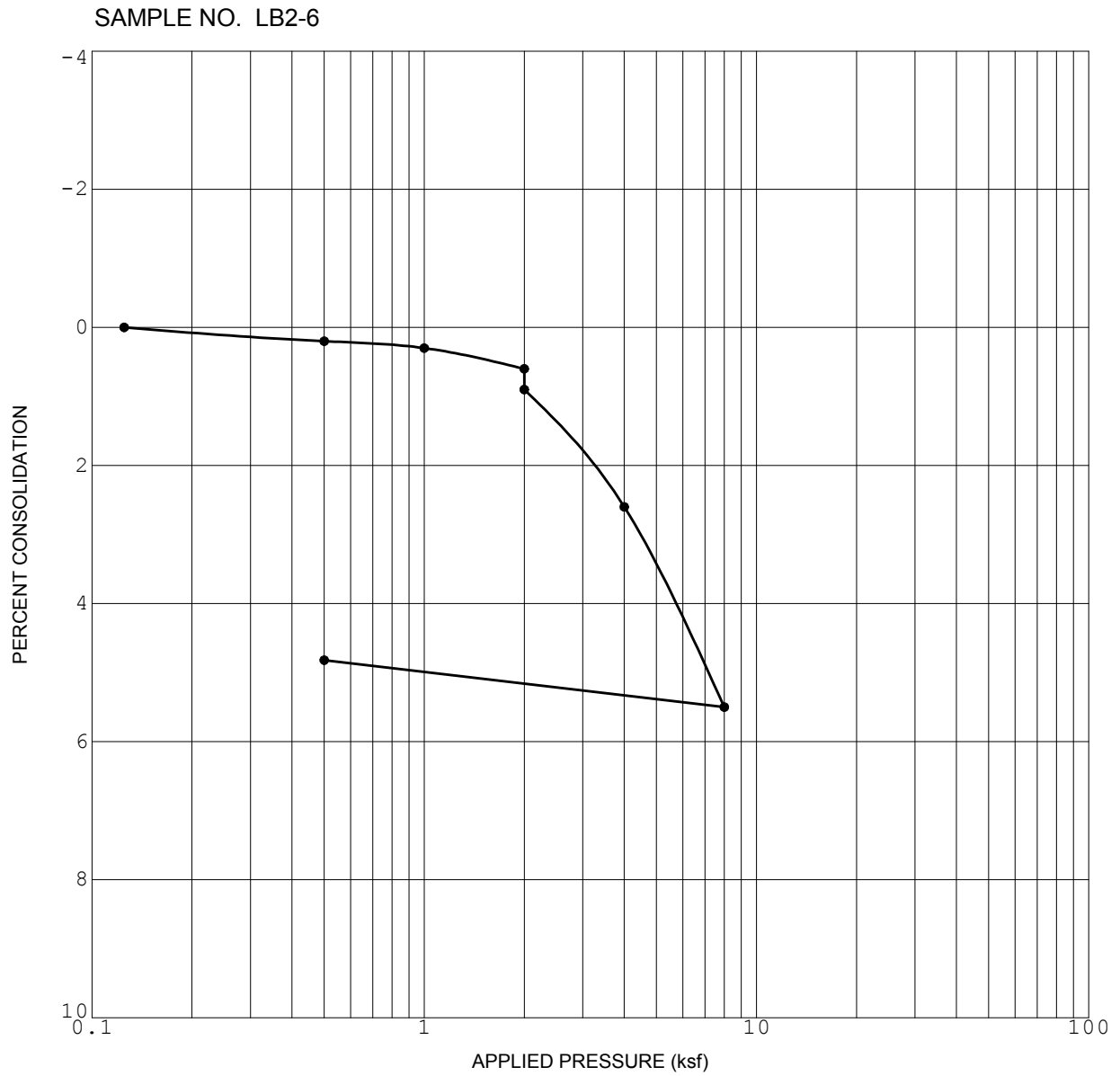

Initial Dry Density (pcf)	112.4
Initial Water Content (%)	10.6

Initial Saturation (%)	59.1
Sample Saturated at (ksf)	2.0

CONSOLIDATION CURVE

3ROOTS

SAN DIEGO, CALIFORNIA

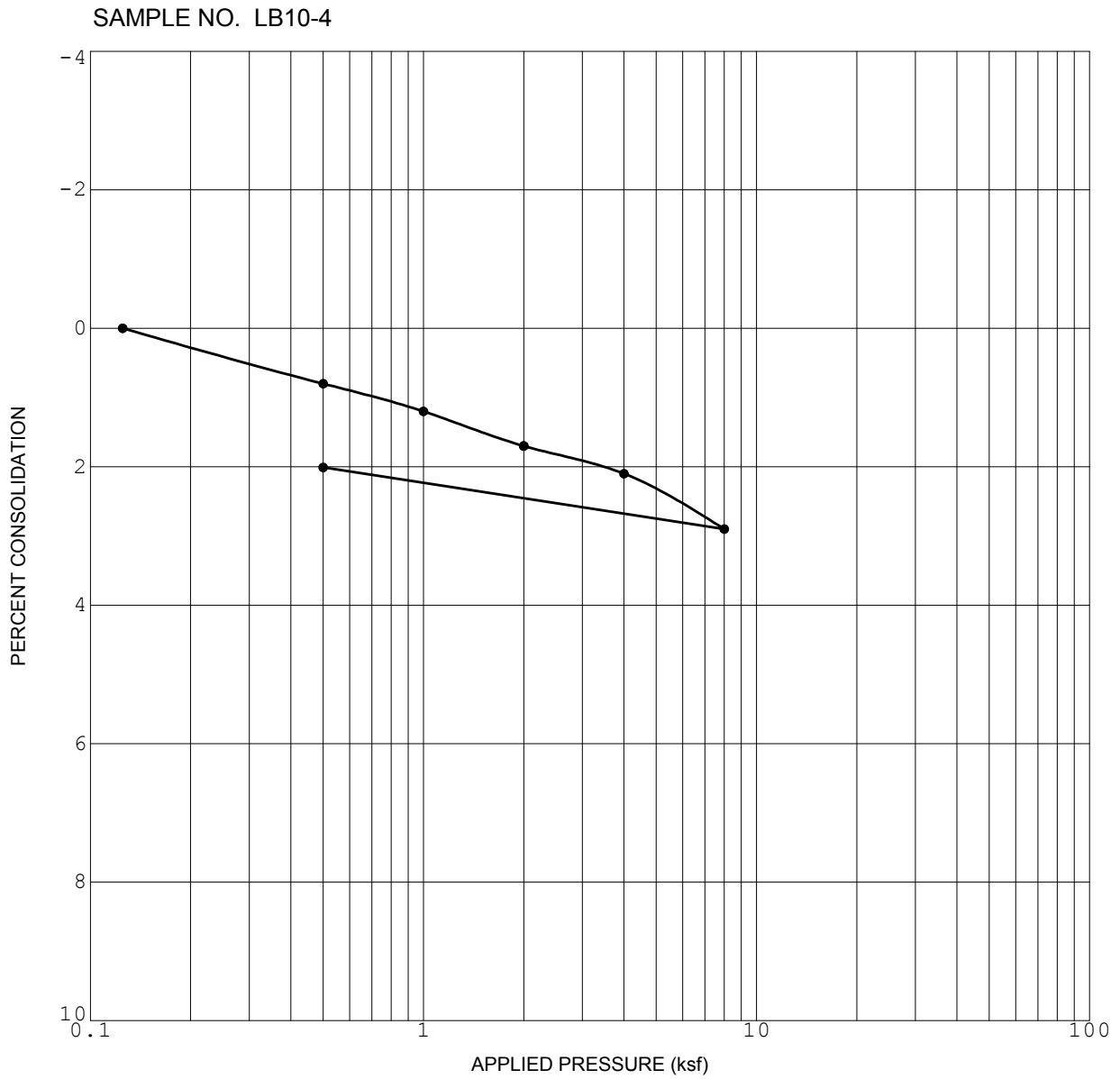

Initial Dry Density (pcf)	125.0
Initial Water Content (%)	13.1

Initial Saturation (%)	100
Sample Saturated at (ksf)	2.0

CONSOLIDATION CURVE

3ROOTS

SAN DIEGO, CALIFORNIA

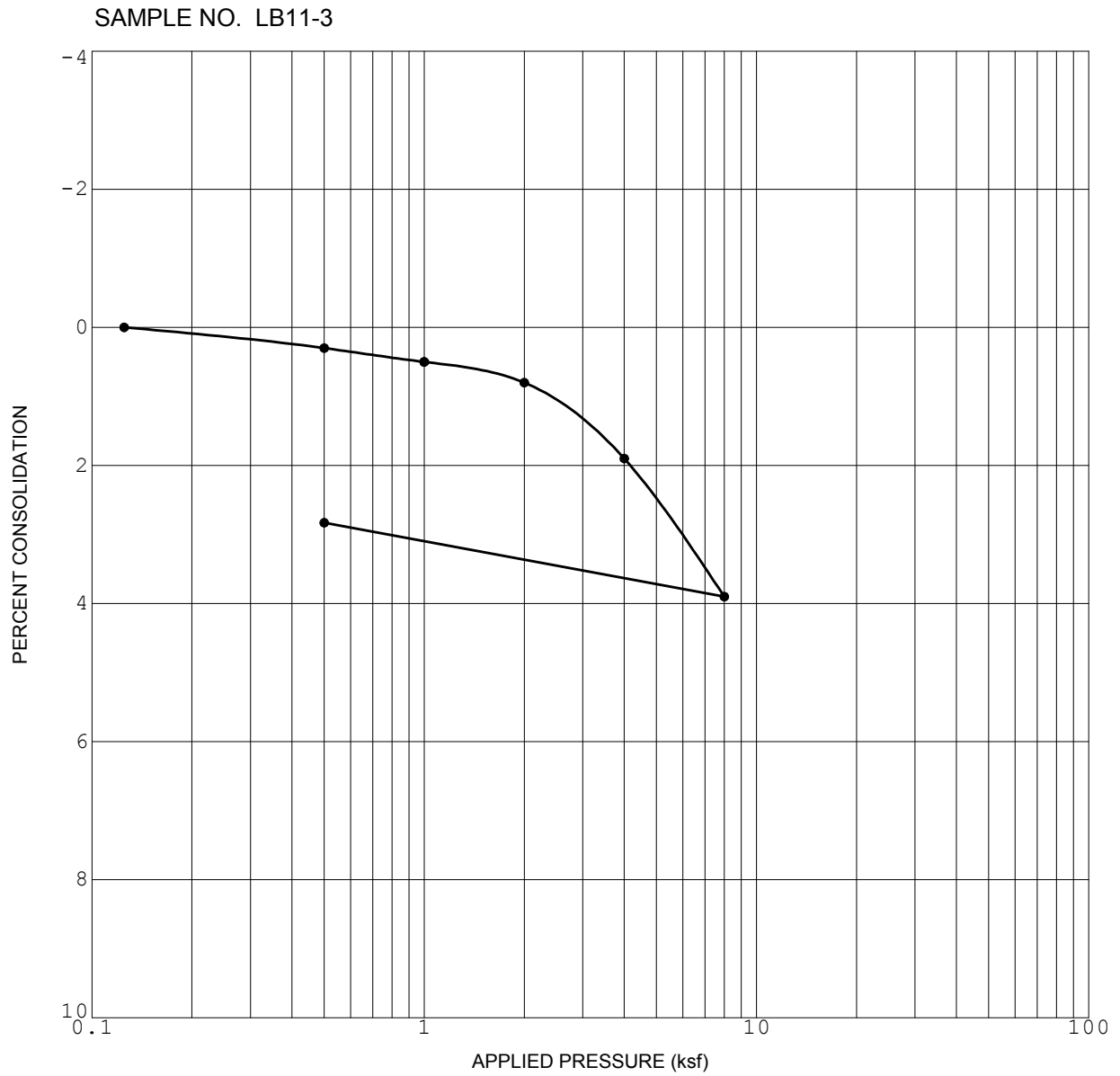

Initial Dry Density (pcf)	118.8
Initial Water Content (%)	11.9

Initial Saturation (%)	79.7
Sample Saturated at (ksf)	1.0

CONSOLIDATION CURVE

3ROOTS

SAN DIEGO, CALIFORNIA

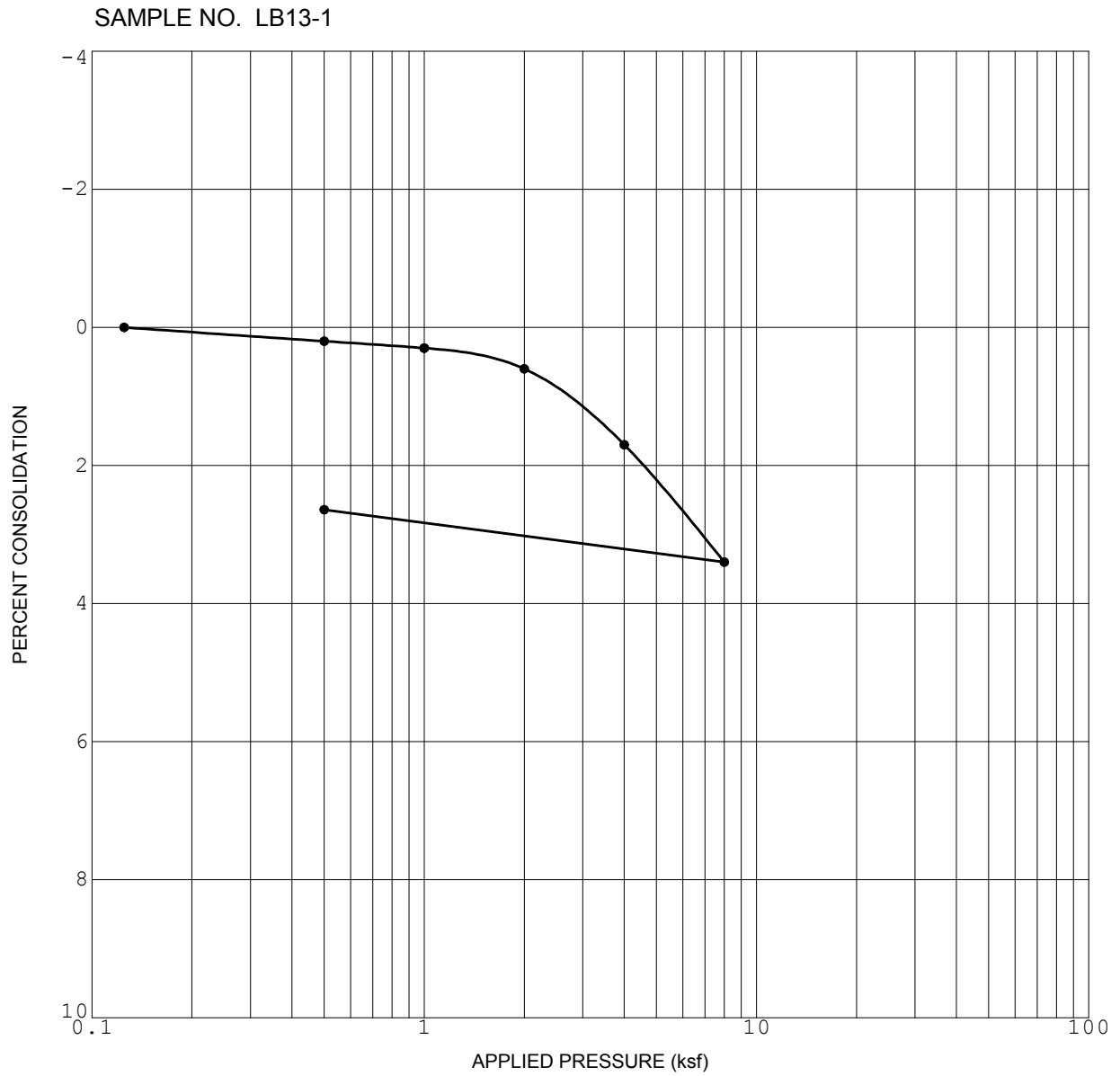

Initial Dry Density (pcf)	119.7
Initial Water Content (%)	12.7

Initial Saturation (%)	87.8
Sample Saturated at (ksf)	1.0

CONSOLIDATION CURVE

3ROOTS

SAN DIEGO, CALIFORNIA

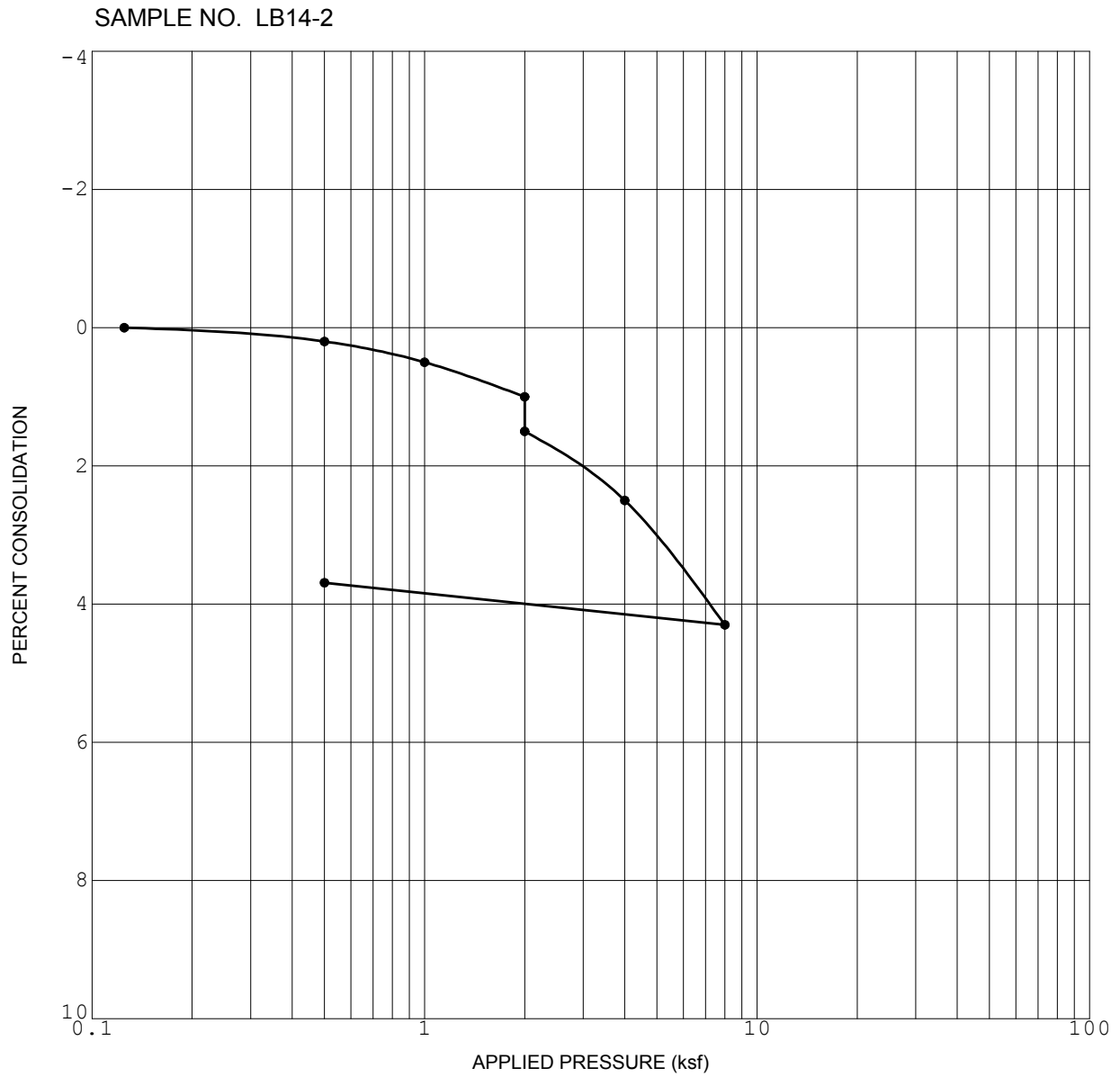

Initial Dry Density (pcf)	116.8
Initial Water Content (%)	13.8

Initial Saturation (%)	87.2
Sample Saturated at (ksf)	2

CONSOLIDATION CURVE

3ROOTS

SAN DIEGO, CALIFORNIA

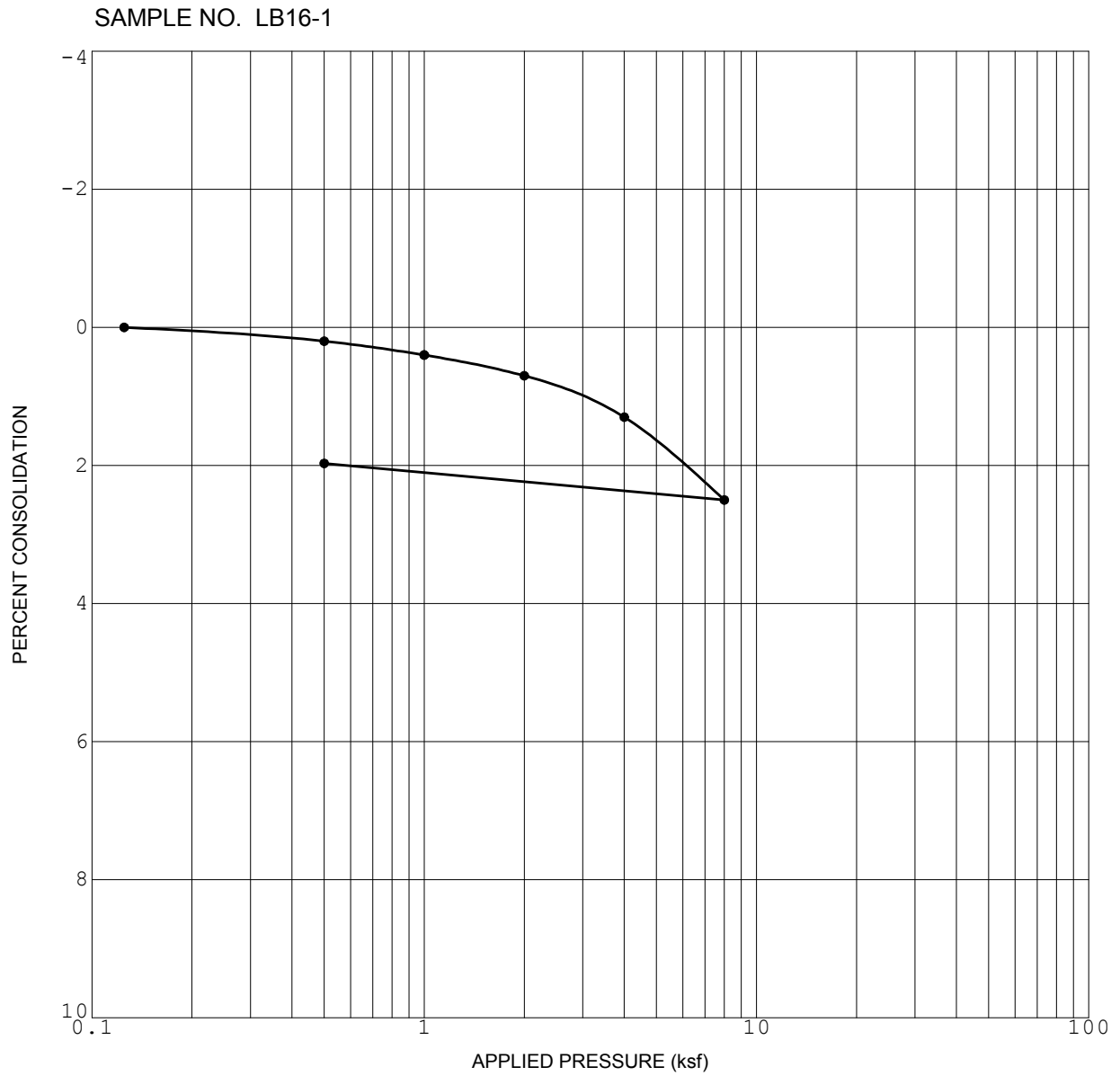

Initial Dry Density (pcf)	119.0
Initial Water Content (%)	12.2

Initial Saturation (%)	82.5
Sample Saturated at (ksf)	1.0

CONSOLIDATION CURVE

3ROOTS

SAN DIEGO, CALIFORNIA

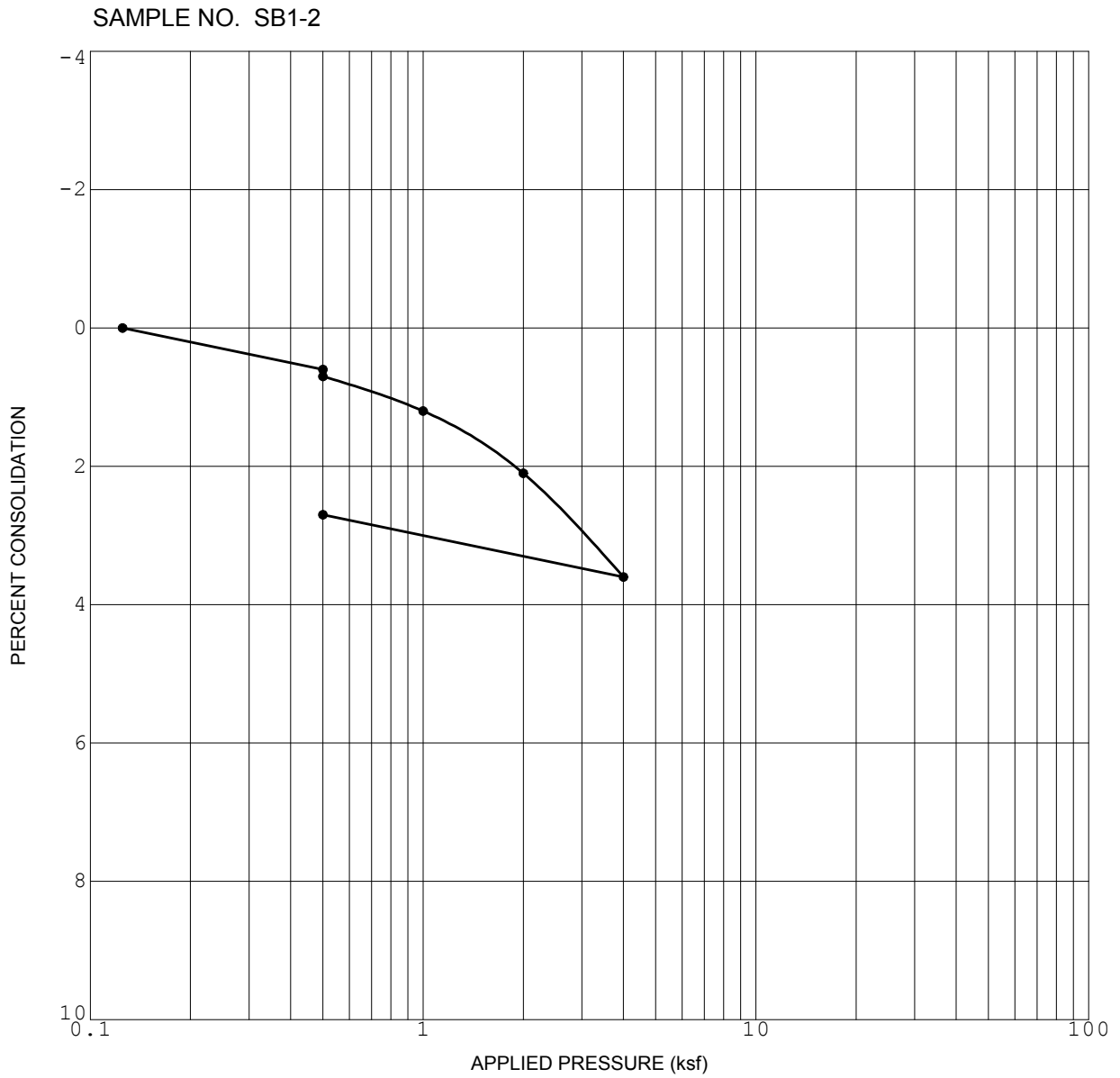

Initial Dry Density (pcf)	109.8
Initial Water Content (%)	12.3

Initial Saturation (%)	71.3
Sample Saturated at (ksf)	.5

CONSOLIDATION CURVE

3ROOTS

SAN DIEGO, CALIFORNIA

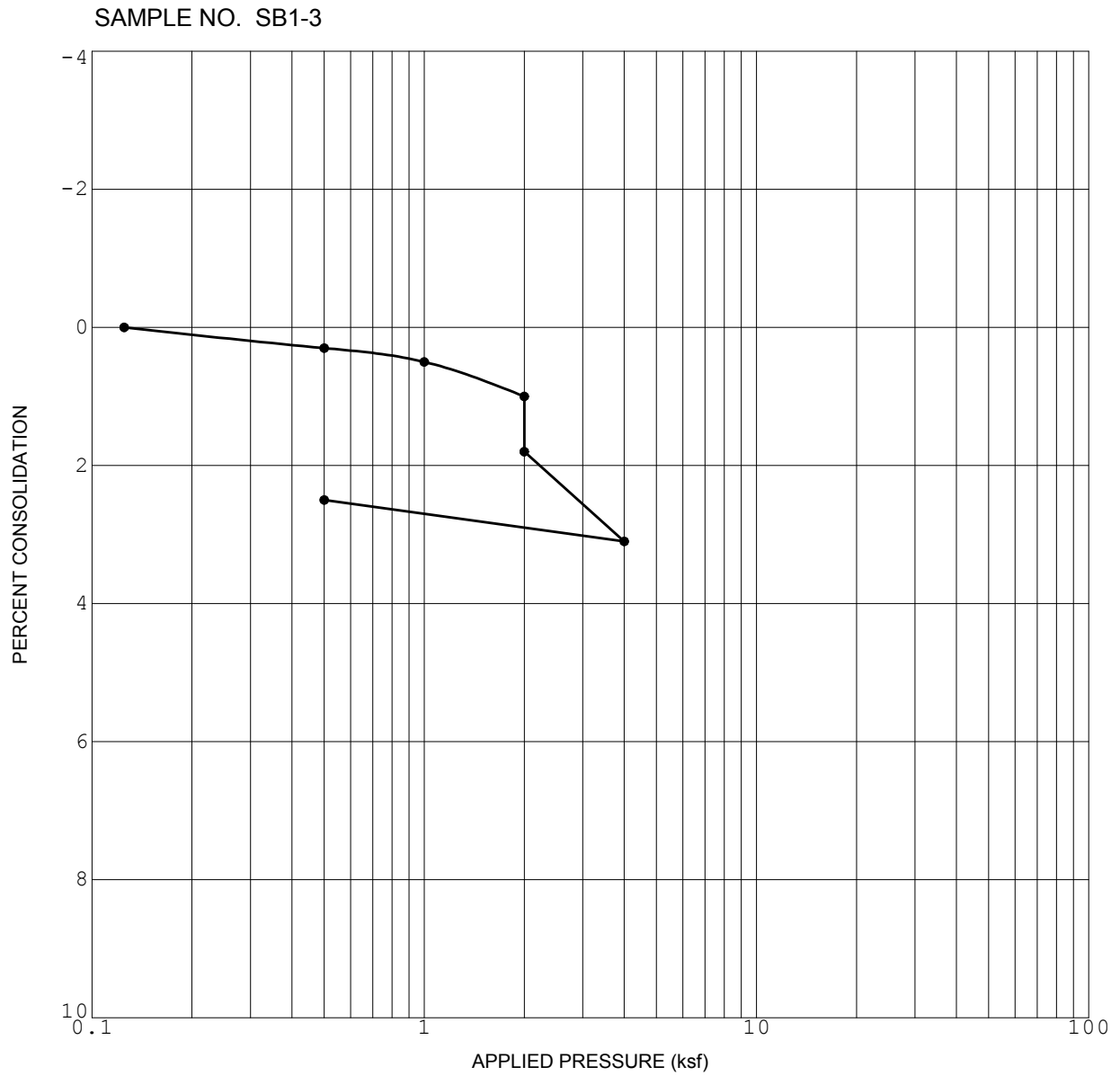

Initial Dry Density (pcf)	114.6
Initial Water Content (%)	10.4

Initial Saturation (%)	61.6
Sample Saturated at (ksf)	2.0

CONSOLIDATION CURVE

3ROOTS

SAN DIEGO, CALIFORNIA

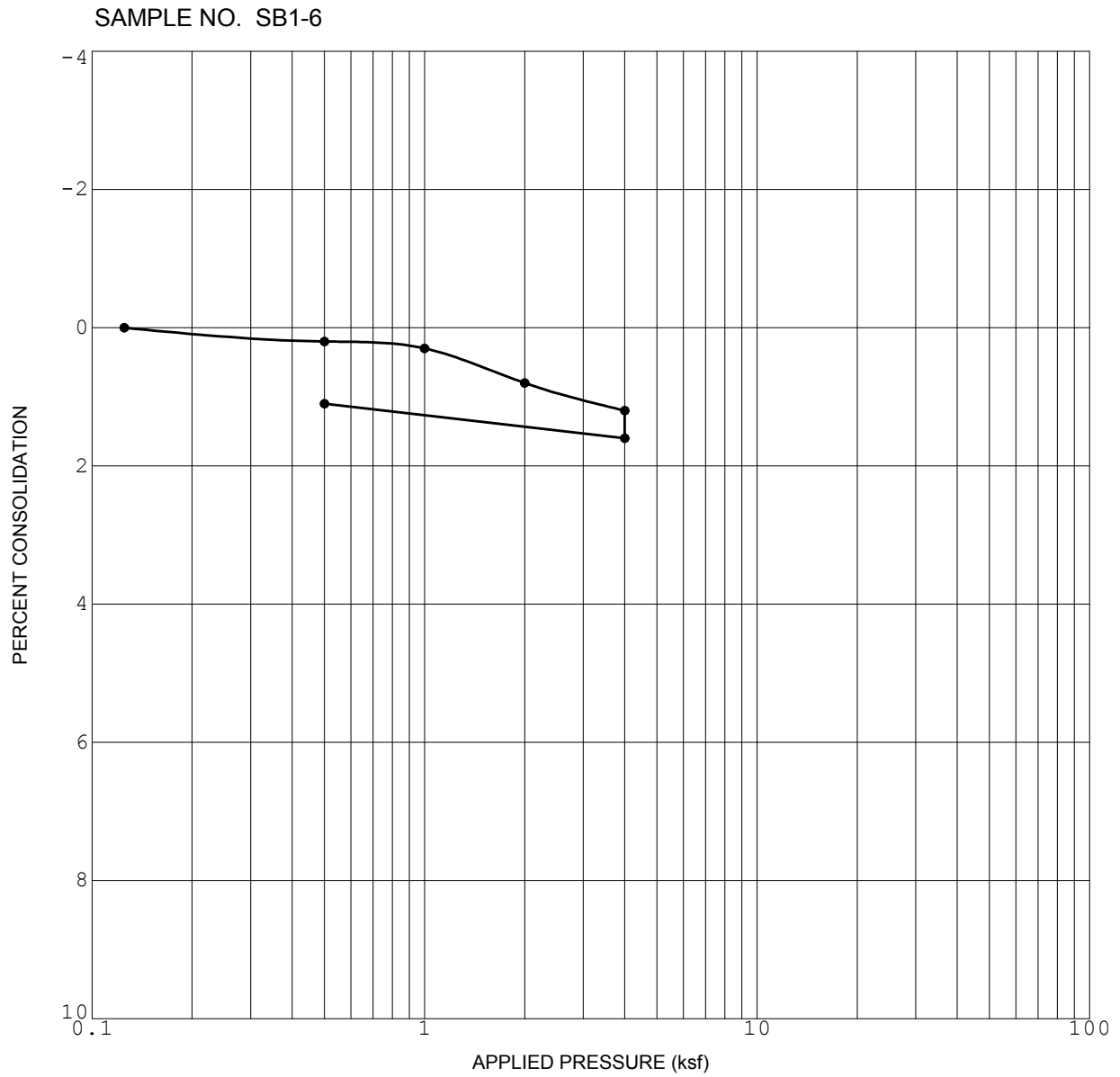

Initial Dry Density (pcf)	115.9
Initial Water Content (%)	10.3

Initial Saturation (%)	63.6
Sample Saturated at (ksf)	4.0

CONSOLIDATION CURVE

3ROOTS

SAN DIEGO, CALIFORNIA

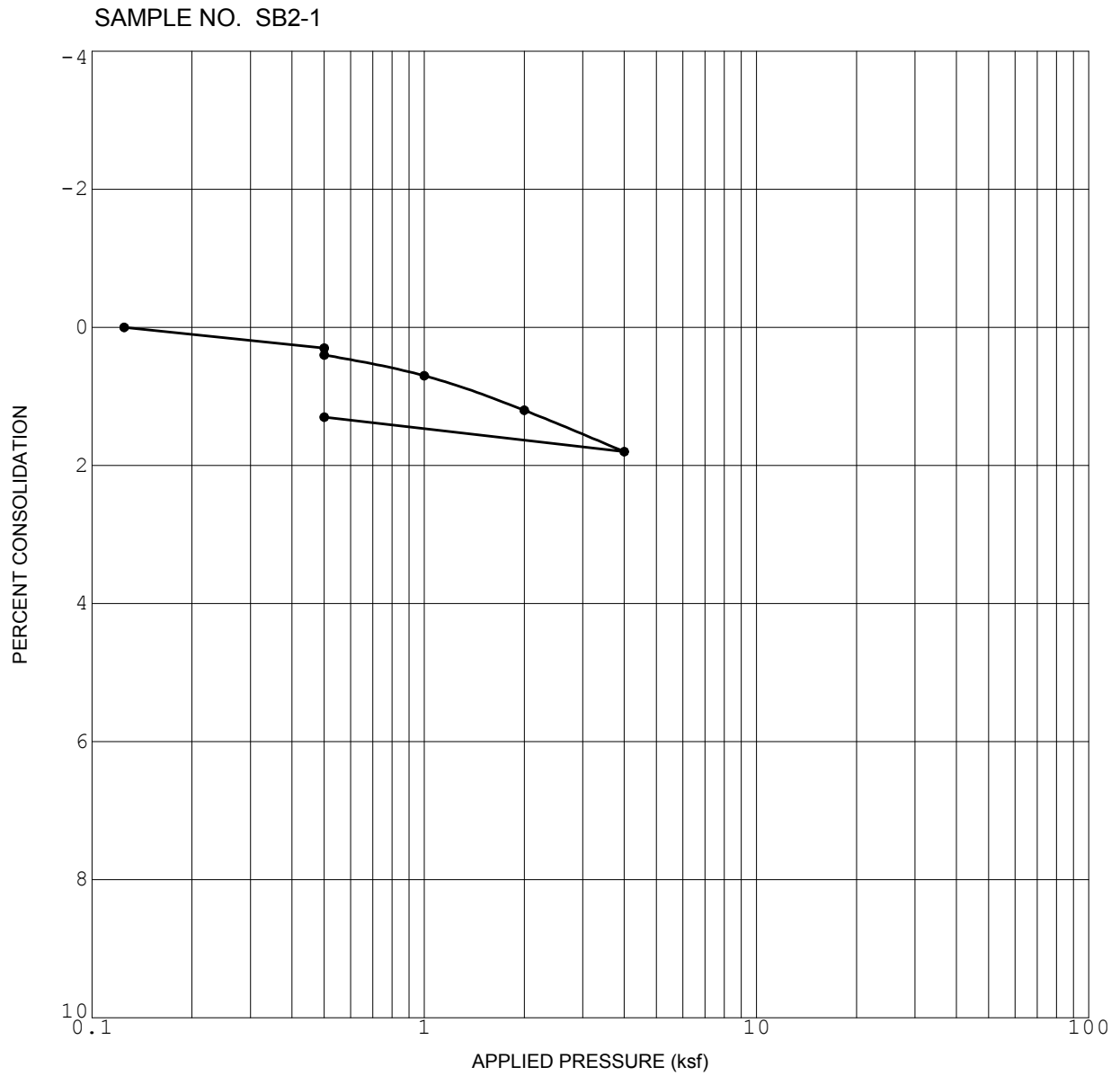

Initial Dry Density (pcf)	119.2
Initial Water Content (%)	10.0

Initial Saturation (%)	67.7
Sample Saturated at (ksf)	.5

CONSOLIDATION CURVE

3ROOTS

SAN DIEGO, CALIFORNIA

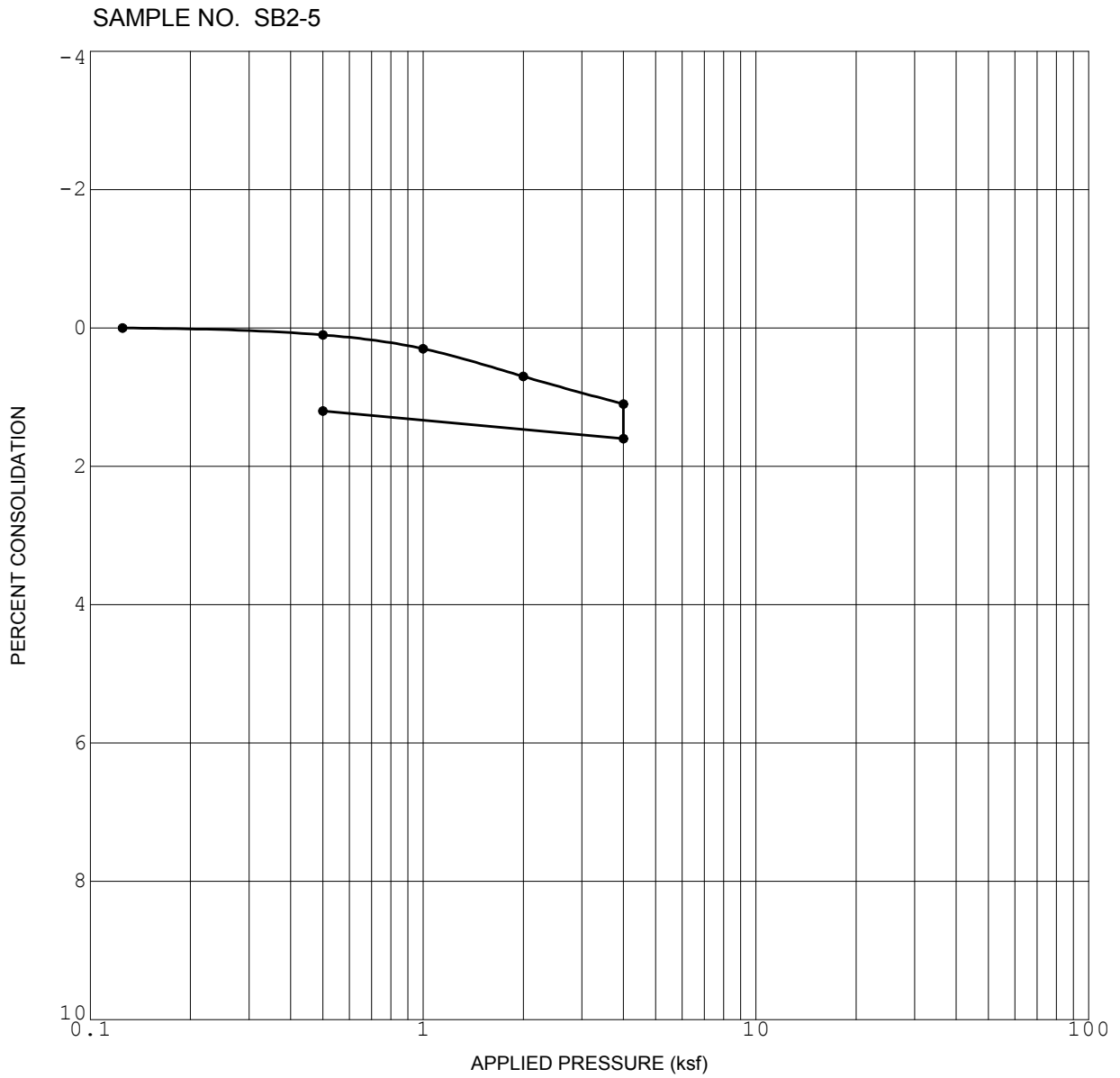

Initial Dry Density (pcf)	112.6
Initial Water Content (%)	13.7

Initial Saturation (%)	76.9
Sample Saturated at (ksf)	4.0

CONSOLIDATION CURVE

3ROOTS

SAN DIEGO, CALIFORNIA

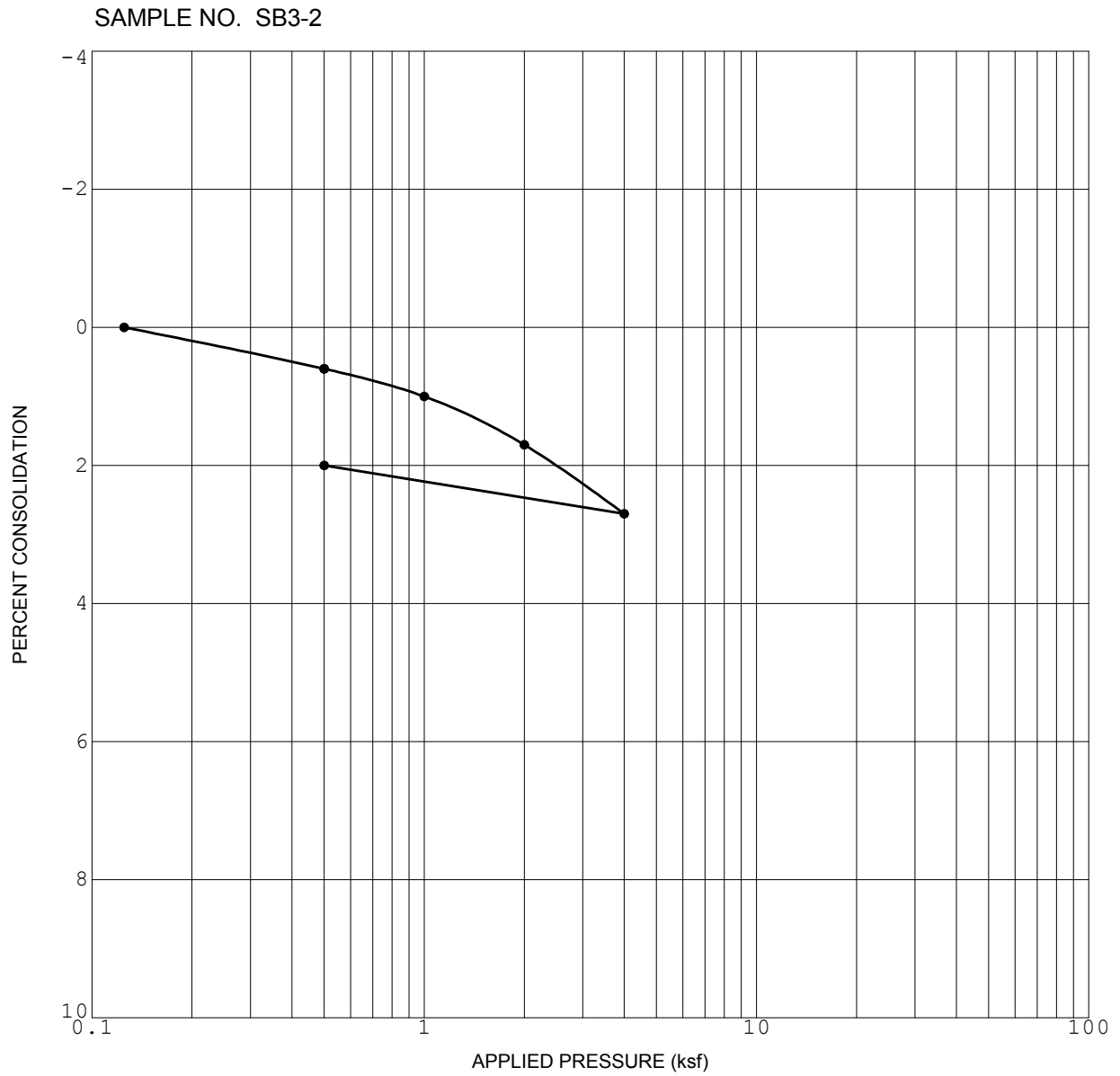

Initial Dry Density (pcf)	119.0
Initial Water Content (%)	10.5

Initial Saturation (%)	70.8
Sample Saturated at (ksf)	.5

CONSOLIDATION CURVE

3ROOTS

SAN DIEGO, CALIFORNIA

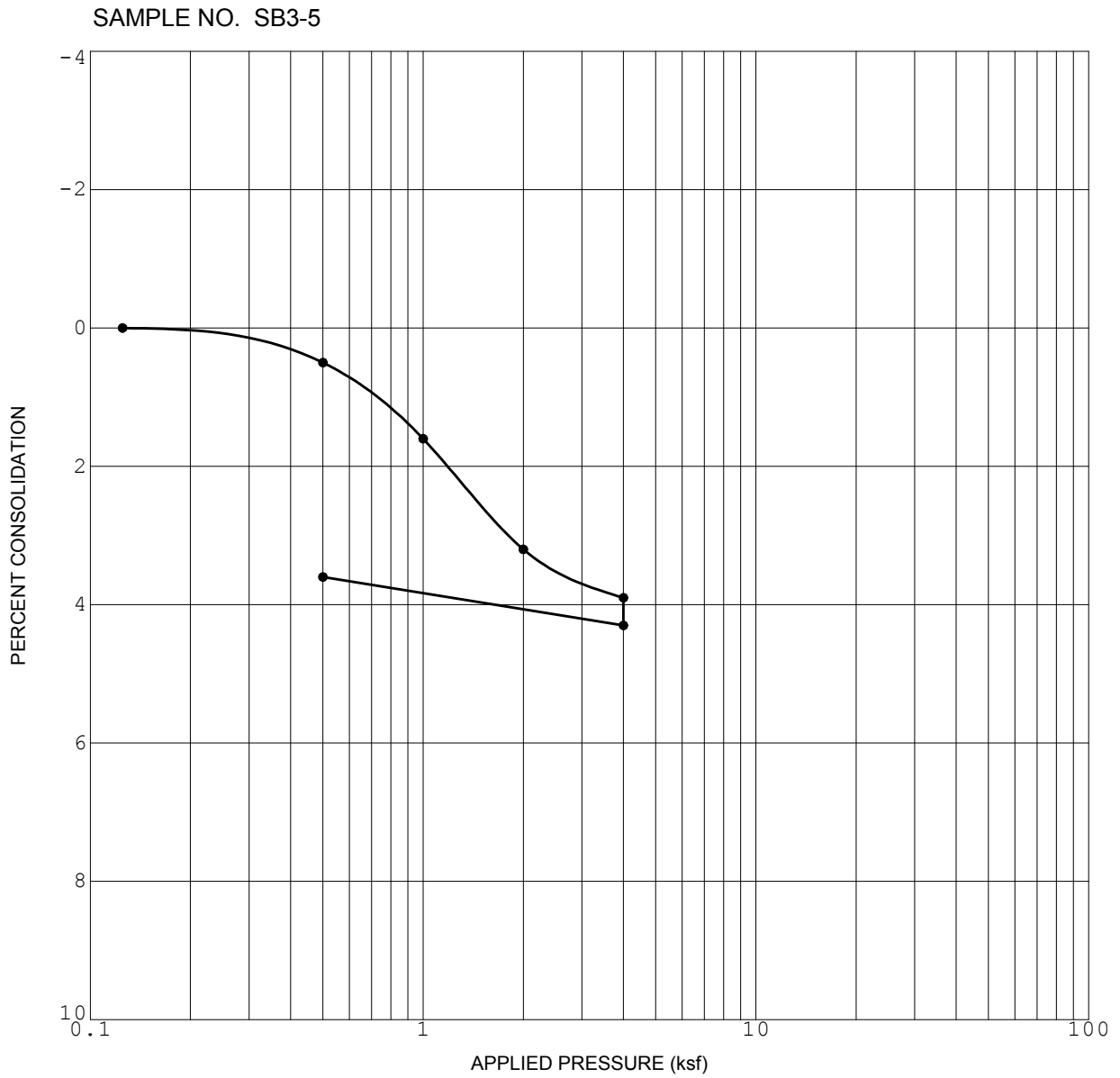

Initial Dry Density (pcf)	119.1
Initial Water Content (%)	13.5

Initial Saturation (%)	91.6
Sample Saturated at (ksf)	4.0

CONSOLIDATION CURVE

3ROOTS

SAN DIEGO, CALIFORNIA

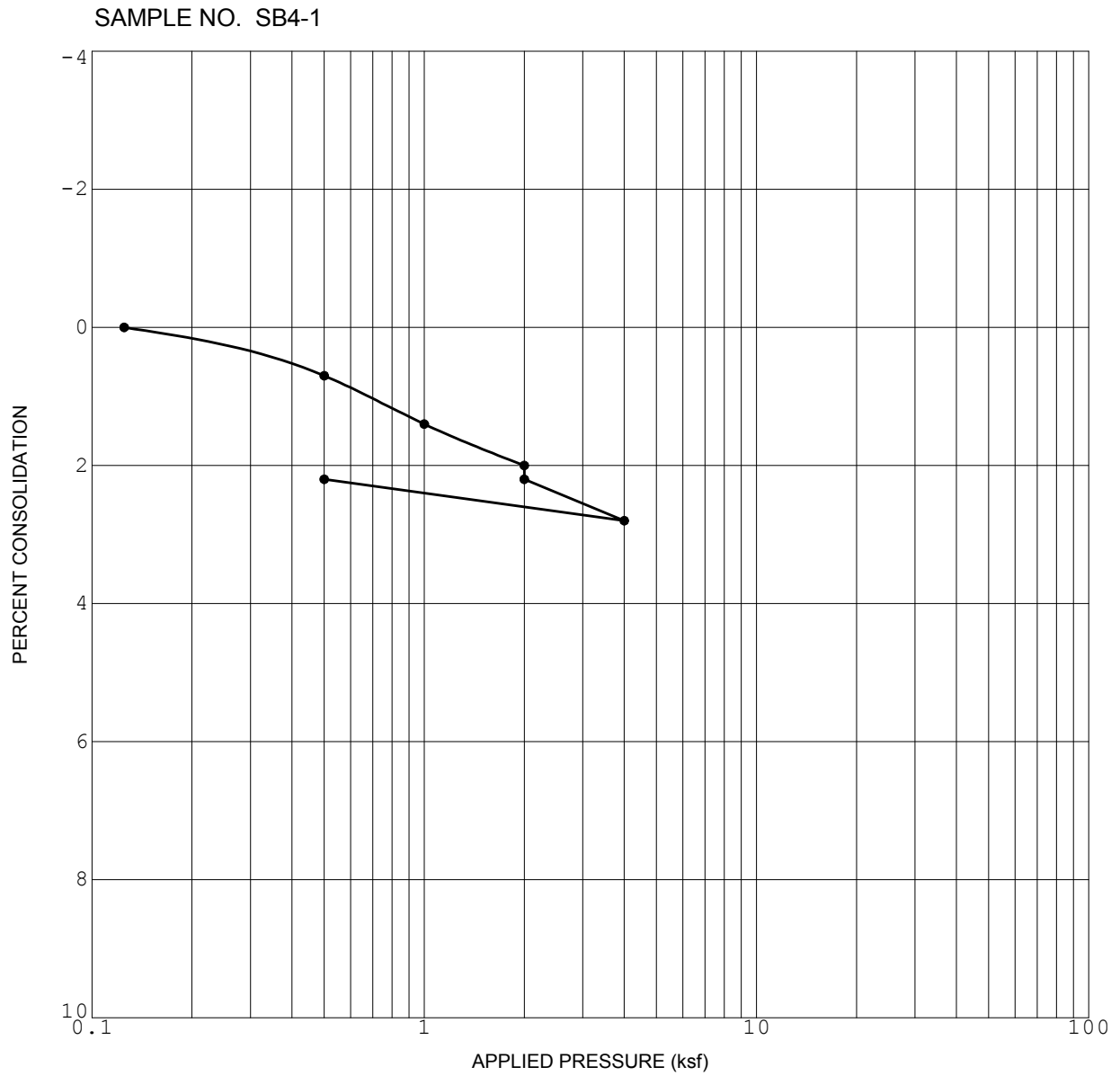

Initial Dry Density (pcf)	121.4
Initial Water Content (%)	10.4

Initial Saturation (%)	75.1
Sample Saturated at (ksf)	2.0

CONSOLIDATION CURVE

3ROOTS

SAN DIEGO, CALIFORNIA

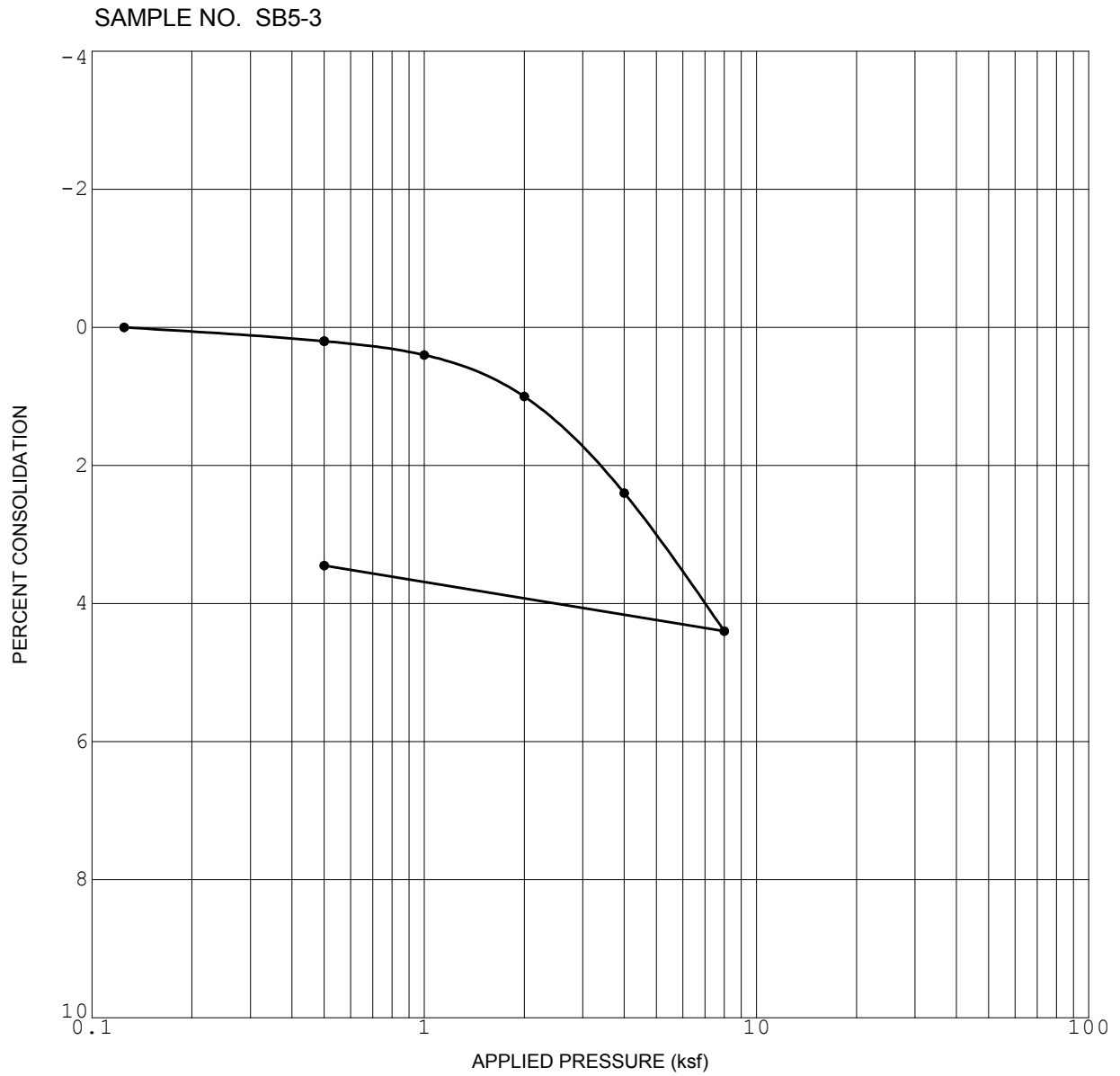

Initial Dry Density (pcf)	116.3
Initial Water Content (%)	12.0

Initial Saturation (%)	74.8
Sample Saturated at (ksf)	.5

CONSOLIDATION CURVE

3ROOTS

SAN DIEGO, CALIFORNIA

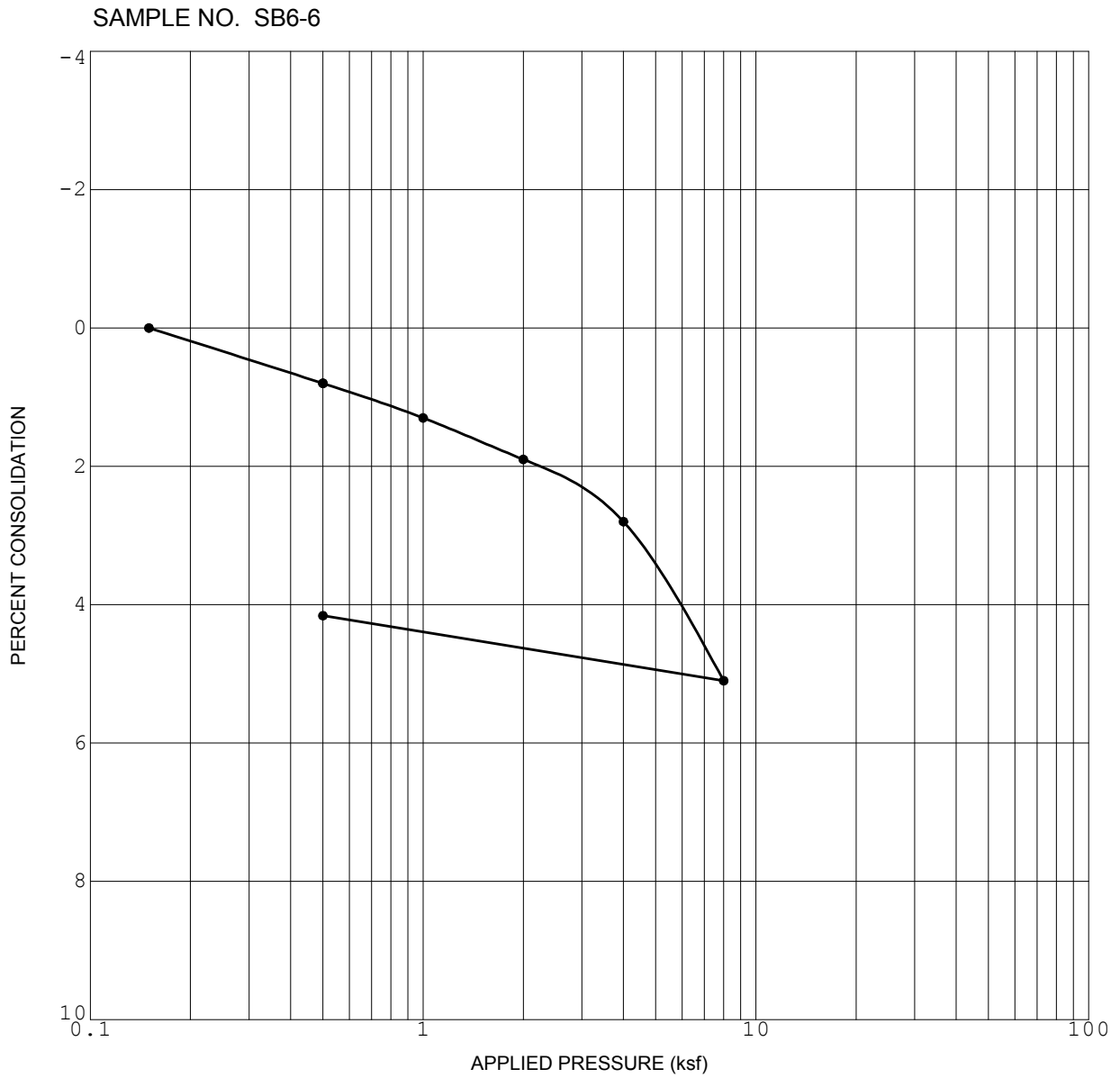

Initial Dry Density (pcf)	123.2
Initial Water Content (%)	10.1

Initial Saturation (%)	77.2
Sample Saturated at (ksf)	.5

CONSOLIDATION CURVE

3ROOTS

SAN DIEGO, CALIFORNIA

APPENDIX

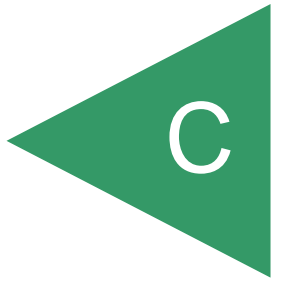

APPENDIX C

STORM WATER MANAGEMENT

We understand storm water management devices are being proposed in accordance with the current Storm Water Standards (SWS). If not properly constructed, there is a potential for distress to improvements and properties located hydrologically down gradient or adjacent to these devices. Factors such as the amount of water to be detained, its residence time, and soil permeability have an important effect on seepage transmission and the potential adverse impacts that may occur if the storm water management features are not properly designed and constructed. We have not performed a hydrogeological study at the site. If infiltration of storm water runoff occurs, downstream properties and improvements may be subjected to seeps, springs, slope instability, raised groundwater, movement of foundations and slabs, or other undesirable impacts as a result of water infiltration.

Hydrologic Soil Group

The United States Department of Agriculture (USDA), Natural Resources Conservation Services, possesses general information regarding the existing soil conditions for areas within the United States. The USDA website also provides the Hydrologic Soil Group. Table C-1 presents the descriptions of the hydrologic soil groups.

**TABLE C-1
HYDROLOGIC SOIL GROUP DEFINITIONS**

Soil Group	Soil Group Definition
A	Soils having a high infiltration rate (low runoff potential) when thoroughly wet. These consist mainly of deep, well drained to excessively drained sands or gravelly sands. These soils have a high rate of water transmission.
B	Soils having a moderate infiltration rate when thoroughly wet. These consist chiefly of moderately deep or deep, moderately well drained or well drained soils that have moderately fine texture to moderately coarse texture. These soils have a moderate rate of water transmission.
C	Soils having a slow infiltration rate when thoroughly wet. These consist chiefly of soils having a layer that impedes the downward movement of water or soils of moderately fine texture or fine texture. These soils have a slow rate of water transmission.
D	Soils having a very slow infiltration rate (high runoff potential) when thoroughly wet. These consist chiefly of clays that have a high shrink-swell potential, soils that have a high-water table, soils that have a claypan or clay layer at or near the surface, and soils that are shallow over nearly impervious material. These soils have a very slow rate of water transmission.

The property is underlain by undocumented fill, compacted fill, alluvium, colluvium, and the Stadium Conglomerate. Table C-2 presents the information from the USDA website for the subject property.

**TABLE C-2
USDA WEB SOIL SURVEY – HYDROLOGIC SOIL GROUP**

Map Unit Name	Map Unit Symbol	Approximate Percentage of Property	Hydrologic Soil Group
Altamont Clay, 15 to 30 percent slopes	AtE	0.2	C
Gravel Pits	GP	11.8	NA
Olivenhain cobbly loam, 2 to 9 percent slopes	OhC	3	D
Olivenhain cobbly loam, 9 to 30 percent slopes	OhE	5	D
Redding gravelly loam, 2 to 9 percent slopes	RdC	34	D
Redding cobbly loam, 9 to 30 percent slopes	RdE	10	D
Redding cobbly loam, dissected, 15 to 50 percent slopes	RfF	1	D
Riverwash	Rm	15	D
Terrace Escarpments	TeF	20	NA

Infiltration Testing

We performed in-place hydraulic conductivity tests to evaluate the infiltration characteristics of the bedrock geologic unit on the property (Stadium Conglomerate) using a Soilmoisture Corp Aardvark Permeameter. The tests were performed in 8-inch-diameter auger borings. The Geologic Map, Figure 2 shows the approximate locations of the infiltration tests. Table C-3 presents the results of the testing. The calculation sheets are also provided herein.

We used the guidelines presented in the Riverside County Low Impact Development BMP Design Handbook, which references the United States Bureau of Reclamation Well Permeameter Test Method (USBR 7300-89). Based on this widely-accepted guideline, the saturated hydraulic conductivity (Ksat) is equal to the infiltration rate.

The Ksat value determined from the Aardvark Permeameter test is the unfactored infiltration rate. The Ksat (infiltration rate) equation provided in the Riverside County Handbook was used to compute the unfactored infiltration rate.

**TABLE C-3
UNFACTORED HYDRAULIC CONDUCTIVITY TEST RESULTS**

Test No.	Geologic Unit	Infiltration Rate, I (inches/hour)	Factored* Field Infiltration Rate, I (inches/hour)
A-1	Tst	0.015	0.0075
A-2	Tst	0.006	0.003

*Factor of Safety of 2.0 for feasibility determination

STORM WATER MANAGEMENT CONCLUSIONS

Soil Types

Undocumented Fill (Qudf) – We encountered undocumented fill through the site. Recommendations are provided to remove the undocumented fill within structural improvement areas. In non-structural areas, the undocumented fill may be left in place. Infiltration should not occur within the undocumented fill due to the potential for adverse settlement. Undocumented fill is considered infeasible for full or partial infiltration.

Alluvium/Colluvium (Qal/Qc) – Alluvium is present within the creek drainages. Colluvium is present at the base and on the native slopes at the east end of the project. Recommendations are provided to remove replace alluvium and colluvium with compacted fill, therefore, alluvium and colluvium will not be present below proposed basins.

Compacted Fill (Qcf) – Compacted fill exists within several areas on the property. At the completion of grading, compacted fill will exist throughout the majority of the property. Compacted fill thickness up to 100 feet deep are expected. Infiltration should not occur within the compacted fill due to the potential for adverse settlement. Undocumented fill is considered infeasible for full or partial infiltration.

Stadium Conglomerate (Tst) – The Stadium Conglomerate is the underlying bedrock unit and exposed on the cut slopes along the perimeter of the property. The Stadium Conglomerate is very dense and cemented in many locations. The Stadium Conglomerate has very slow infiltration characteristics.

Groundwater Elevation

Groundwater was encountered in several borings within the southern portion of the property, which appears to be perched on the underlying Stadium Conglomerate.

Utilities and Structures

Existing utilities are present on the property. Many of the utilities will be abandoned to enable grading to be performed. Some utilities, including a trunk sewer main and electrical conduit will likely remain in place. Structures on the property will be removed during grading.

Soil or Groundwater Contamination

We are unaware of contaminated soil on the property. Therefore, full and partial infiltration associated with this risk is considered feasible.

Slopes

There are both ascending and descending slopes on the property. We recommend a 50-foot setback from the top of slopes. Basins within 50 feet of the top of slopes should be lined to prevent lateral water migration to the face of the slope.

Infiltration Rates

The results of the infiltration rates in the underlying bedrock of 0.006 to 0.015 inches per hour. The infiltration rates are not high enough to support full or partial infiltration.

Storm Water Management Devices

Because of the presence of undocumented fill, compacted fill, and the very low infiltration rates of the underlying Stadium Conglomerate bedrock, full and partial infiltration is considered infeasible and we recommend the basins be fully lined. The liner should be impermeable (e.g. High-density polyethylene, HDPE, with a thickness of about 30 mil or equivalent Polyvinyl Chloride, PVC). Penetration of the liner should be properly sealed. Drains should be incorporated in the basin to collect storm water runoff and transmit it to a suitable outlet structure. Overflow protection devices should also be incorporated into the design and construction of the basin.

Storm Water Standard Worksheets

The SWS requests the geotechnical engineer complete the *Categorization of Infiltration Feasibility Condition* (Worksheet C.4-1) worksheet information to help evaluate the potential for infiltration on the property. The attached Worksheet C.4-1 presents the completed information for the submittal process.

The regional storm water standards also have a worksheet (Worksheet Form D.5-1) that helps the project civil engineer estimate the factor of safety based on several factors. Table C-4 describes the suitability assessment input parameters related to the geotechnical engineering aspects for the factor of safety determination.

**TABLE C-4
SUITABILITY ASSESSMENT RELATED CONSIDERATIONS FOR
INFILTRATION FACILITY SAFETY FACTORS**

Consideration	High Concern – 3 Points	Medium Concern – 2 Points	Low Concern – 1 Point
Assessment Methods	Use of soil survey maps or simple texture analysis to estimate short-term infiltration rates. Use of well permeameter or borehole methods without accompanying continuous boring log. Relatively sparse testing with direct infiltration methods	Use of well permeameter or borehole methods with accompanying continuous boring log. Direct measurement of infiltration area with localized infiltration measurement methods (e.g., Infiltrometer). Moderate spatial resolution	Direct measurement with localized (i.e. small-scale) infiltration testing methods at relatively high resolution or use of extensive test pit infiltration measurement methods.
Predominant Soil Texture	Silty and clayey soils with significant fines	Loamy soils	Granular to slightly loamy soils
Site Soil Variability	Highly variable soils indicated from site assessment or unknown variability	Soil boring/test pits indicate moderately homogenous soils	Soil boring/test pits indicate relatively homogenous soils
Depth to Groundwater/ Impervious Layer	<5 feet below facility bottom	5-15 feet below facility bottom	>15 feet below facility bottom

Based on our geotechnical investigation and the previous table, Table C-5 presents the estimated factor values for the evaluation of the factor of safety. This table only presents the suitability assessment safety factor (Part A) of the worksheet. The project civil engineer should evaluate the safety factor for design (Part B) and use the combined safety factor for the design infiltration rate.

**TABLE C-5
FACTOR OF SAFETY WORKSHEET D.5-1 DESIGN VALUES¹**

Suitability Assessment Factor Category	Assigned Weight (w)	Factor Value (v)	Product (p = w x v)
Assessment Methods	0.25	2	0.50
Predominant Soil Texture	0.25	2	0.50
Site Soil Variability	0.25	2	0.50
Depth to Groundwater/Impervious Layer	0.25	2	0.55
Suitability Assessment Safety Factor, $S_A = \sum p$			2.0

¹ The project civil engineer should complete Worksheet D.5-1 using the data on this table. Additional information is required to evaluate the design factor of safety.

CONCLUSIONS

Our results indicate the underlying bedrock has very slow infiltration characteristics. Considering the presence of undocumented fill and relatively thick compacted fills, and the slow infiltration characteristics of the bedrock on the property, we recommend the basins utilize an impermeable liner.



Aardvark Permeameter Data Analysis

Project Name: 3Roots
 Project Number: G2070-42-02
 Test Number: A-2

Date: 8/4/2017
 By: N. BORJA
 Ref. EL (feet, MSL): 0.0
 Bottom EL (feet, MSL): -4.0

Borehole Diameter, d (in.): 8.00
 Borehole Depth, H (in.): 47.75
 Distance Between Reservoir & Top of Borehole (in.): 28.00
 Estimated Depth to Water Table, S (feet): 45.00
 Height APM Raised from Bottom (in.): 2.00
 Pressure Reducer Used: No

Distance Between Reservoir and APM Float, D (in.): 66.50
 Head Height Calculated, h (in.): 5.72
 Head Height Measured, h (in.): 4.88
 Distance Between Constant Head and Water Table, L (in.): 497.13

Reading	Time Elapsed (min)	Water Weight Consummed (lbs)	Water Volume Consummed (in ³)	Q (in ³ /min)
1	0.00	0.000	0.00	0.00
2	5.00	10.045	278.17	55.634
3	5.00	0.600	16.62	3.323
4	10.00	0.225	6.23	0.623
5	10.00	0.105	2.91	0.291
6	10.00	0.090	2.49	0.249
7	10.00	0.115	3.18	0.318
8	10.00	0.195	5.40	0.540
9	10.00	0.205	5.68	0.568
10	10.00	0.070	1.94	0.194
11	10.00	0.075	2.08	0.208
12	10.00	0.070	1.94	0.194
Steady Flow Rate, Q (in ³ /min):				0.198

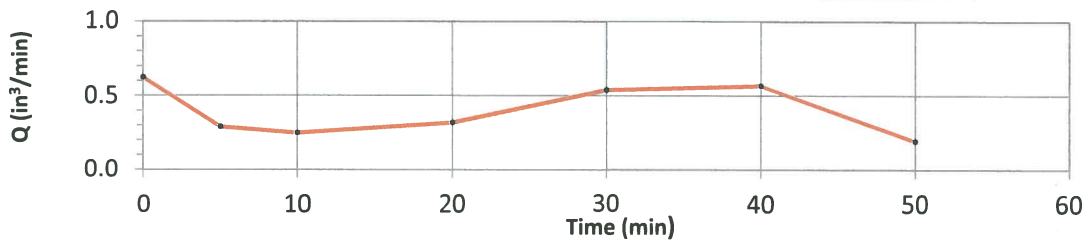

Soil Matrix Flux Potential, ϕ_m

$\phi_m =$ in²/min

Field-Saturated Hydraulic Conductivity (Infiltration Rate)

$K_{sat} =$ in/min in/hr

Appendix C: Geotechnical and Groundwater Investigation Requirements

Categorization of Infiltration Feasibility Condition		Worksheet C.4-1	
<p><u>Part 1 - Full Infiltration Feasibility Screening Criteria</u></p> <p>Would infiltration of the full design volume be feasible from a physical perspective without any undesirable consequences that cannot be reasonably mitigated?</p>			
Criteria	Screening Question	Yes	No
1	<p>Is the estimated reliable infiltration rate below proposed facility locations greater than 0.5 inches per hour? The response to this Screening Question shall be based on a comprehensive evaluation of the factors presented in Appendix C.2 and Appendix D.</p>		X
<p>Provide basis:</p> <p>The results of the field infiltration tests are as follows: A-1: 0.015 inches/hour (0.0075 with a FOS of 2.0) A-2: 0.006 inches/hour (0.003 with a FOS of 2.0)</p> <p>The rates are less than 0.5 inches/hour. Therefore, full infiltration is not feasible.</p>			
2	<p>Can infiltration greater than 0.5 inches per hour be allowed without increasing risk of geotechnical hazards (slope stability, groundwater mounding, utilities, or other factors) that cannot be mitigated to an acceptable level? The response to this Screening Question shall be based on a comprehensive evaluation of the factors presented in Appendix C.2.</p>		X
<p>Provide basis:</p> <p>Based on the comprehensive study presented in the geotechnical documents, infiltration could not be incorporated without increasing the risk of geotechnical hazards including settlement within undocumented and compacted fill and uncontrolled water lateral migration.</p> <p>The very slow infiltration rates in the Stadium Conglomerate suggest lateral migration of infiltration water will likely occur. The uncontrolled lateral migration could impact existing and proposed adjacent improvements and utilities.</p>			

Appendix C: Geotechnical and Groundwater Investigation Requirements

Worksheet C.4-1 Page 2 of 4			
Criteria	Screening Question	Yes	No
3	Can infiltration greater than 0.5 inches per hour be allowed without increasing risk of groundwater contamination (shallow water table, storm water pollutants or other factors) that cannot be mitigated to an acceptable level? The response to this Screening Question shall be based on a comprehensive evaluation of the factors presented in Appendix C.3.	X	
<p>Provide basis:</p> <p>The groundwater elevation was found to be in excess of 15 feet below existing grades. It is our opinion that there is no significant increase in risk of groundwater contamination due to infiltration.</p>			
4	Can infiltration greater than 0.5 inches per hour be allowed without causing potential water balance issues such as change of seasonality of ephemeral streams or increased discharge of contaminated groundwater to surface waters? The response to this Screening Question shall be based on a comprehensive evaluation of the factors presented in Appendix C.3.	X	
<p>Provide basis:</p> <p>We do not expect infiltration will cause water balance issues such as seasonality of ephemeral streams or increased discharge of contaminated groundwater to surface waters.</p>			
Part 1 Result*	<p>If all answers to rows 1 - 4 are “Yes” a full infiltration design is potentially feasible. The feasibility screening category is Full Infiltration</p> <p>If any answer from row 1-4 is “No”, infiltration may be possible to some extent but would not generally be feasible or desirable to achieve a “full infiltration” design. Proceed to Part 2</p>		No

*To be completed using gathered site information and best professional judgment considering the definition of MEP in the MS4 Permit. Additional testing and/or studies may be required by the City to substantiate findings.

Appendix C: Geotechnical and Groundwater Investigation Requirements

Worksheet C.4-1 Page 3 of 4			
Part 2 – Partial Infiltration vs. No Infiltration Feasibility Screening Criteria			
Would infiltration of water in any appreciable amount be physically feasible without any negative consequences that cannot be reasonably mitigated?			
Criteria	Screening Question	Yes	No
5	Do soil and geologic conditions allow for infiltration in any appreciable rate or volume? The response to this Screening Question shall be based on a comprehensive evaluation of the factors presented in Appendix C.2 and Appendix D.		X
<p>Provide basis:</p> <p>The results of the field infiltration tests are as follows: A-1: 0.015 inches/hour (0.0075 with a FOS of 2.0) A-2: 0.006 inches/hour (0.003 with a FOS of 2.0)</p> <p>The rates are less than 0.1 inches/hour. The test results indicate that the geologic conditions do not allow for appreciable infiltration rate. Partial infiltration is not feasible.</p>			
6	Can Infiltration in any appreciable quantity be allowed without increasing risk of geotechnical hazards (slope stability, groundwater mounding, utilities, or other factors) that cannot be mitigated to an acceptable level? The response to this Screening Question shall be based on a comprehensive evaluation of the factors presented in Appendix C.2.		X
<p>Provide basis:</p> <p>Based on the comprehensive study presented in the geotechnical documents, infiltration could not be incorporated without increasing the risk of geotechnical hazards including settlement within undocumented and compacted fill and uncontrolled water lateral migration.</p> <p>The very slow infiltration rates in the Stadium Conglomerate suggest lateral migration of infiltration water will likely occur. The uncontrolled lateral migration could impact existing and proposed adjacent improvements and utilities.</p>			

Worksheet C.4-1 Page 4 of 4			
Criteria	Screening Question	Yes	No
7	<p>Can Infiltration in any appreciable quantity be allowed without posing significant risk for groundwater related concerns (shallow water table, storm water pollutants or other factors)? The response to this Screening Question shall be based on a comprehensive evaluation of the factors presented in Appendix C.3.</p>	X	
<p>Provide basis:</p> <p>The groundwater elevation is assumed to be in excess of 15 feet below existing grades. It is our opinion that there is no significant increase in risk of groundwater contamination due to infiltration.</p> <p>Summarize findings of studies; provide reference to studies, calculations, maps, data sources, etc. Provide narrative discussion of study/data source applicability and why it was not feasible to mitigate low infiltration rates.</p>			
8	<p>Can infiltration be allowed without violating downstream water rights? The response to this Screening Question shall be based on a comprehensive evaluation of the factors presented in Appendix C.3.</p>	X	
<p>Provide basis:</p> <p>We did not provide a study regarding water rights. However, these rights are not typical in the San Diego area.</p> <p>Summarize findings of studies; provide reference to studies, calculations, maps, data sources, etc. Provide narrative discussion of study/data source applicability and why it was not feasible to mitigate low infiltration rates.</p>			
Part 2 Result*	<p>If all answers from row 1-4 are yes then partial infiltration design is potentially feasible. The feasibility screening category is Partial Infiltration.</p> <p>If any answer from row 5-8 is no, then infiltration of any volume is considered to be infeasible within the drainage area. The feasibility screening category is No Infiltration.</p>		No

*To be completed using gathered site information and best professional judgment considering the definition of MEP in the MS4 Permit. Additional testing and/or studies may be required by the City to substantiate findings.

APPENDIX

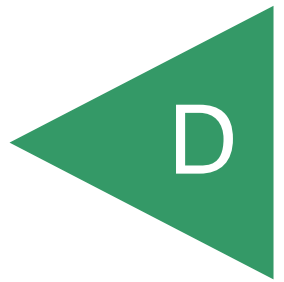

APPENDIX D
RECOMMENDED GRADING SPECIFICATIONS
FOR
3ROOTS
SAN DIEGO, CALIFORNIA
PROJECT NO. G2070-42-02

RECOMMENDED GRADING SPECIFICATIONS

1. GENERAL

- 1.1 These Recommended Grading Specifications shall be used in conjunction with the Geotechnical Report for the project prepared by Geocon. The recommendations contained in the text of the Geotechnical Report are a part of the earthwork and grading specifications and shall supersede the provisions contained hereinafter in the case of conflict.
- 1.2 Prior to the commencement of grading, a geotechnical consultant (Consultant) shall be employed for the purpose of observing earthwork procedures and testing the fills for substantial conformance with the recommendations of the Geotechnical Report and these specifications. The Consultant should provide adequate testing and observation services so that they may assess whether, in their opinion, the work was performed in substantial conformance with these specifications. It shall be the responsibility of the Contractor to assist the Consultant and keep them apprised of work schedules and changes so that personnel may be scheduled accordingly.
- 1.3 It shall be the sole responsibility of the Contractor to provide adequate equipment and methods to accomplish the work in accordance with applicable grading codes or agency ordinances, these specifications and the approved grading plans. If, in the opinion of the Consultant, unsatisfactory conditions such as questionable soil materials, poor moisture condition, inadequate compaction, and/or adverse weather result in a quality of work not in conformance with these specifications, the Consultant will be empowered to reject the work and recommend to the Owner that grading be stopped until the unacceptable conditions are corrected.

2. DEFINITIONS

- 2.1 **Owner** shall refer to the owner of the property or the entity on whose behalf the grading work is being performed and who has contracted with the Contractor to have grading performed.
- 2.2 **Contractor** shall refer to the Contractor performing the site grading work.
- 2.3 **Civil Engineer** or **Engineer of Work** shall refer to the California licensed Civil Engineer or consulting firm responsible for preparation of the grading plans, surveying and verifying as-graded topography.
- 2.4 **Consultant** shall refer to the soil engineering and engineering geology consulting firm retained to provide geotechnical services for the project.

- 2.5 **Soil Engineer** shall refer to a California licensed Civil Engineer retained by the Owner, who is experienced in the practice of geotechnical engineering. The Soil Engineer shall be responsible for having qualified representatives on-site to observe and test the Contractor's work for conformance with these specifications.
- 2.6 **Engineering Geologist** shall refer to a California licensed Engineering Geologist retained by the Owner to provide geologic observations and recommendations during the site grading.
- 2.7 **Geotechnical Report** shall refer to a soil report (including all addenda) which may include a geologic reconnaissance or geologic investigation that was prepared specifically for the development of the project for which these Recommended Grading Specifications are intended to apply.

3. MATERIALS

- 3.1 Materials for compacted fill shall consist of any soil excavated from the cut areas or imported to the site that, in the opinion of the Consultant, is suitable for use in construction of fills. In general, fill materials can be classified as *soil* fills, *soil-rock* fills or *rock* fills, as defined below.
- 3.1.1 **Soil fills** are defined as fills containing no rocks or hard lumps greater than 12 inches in maximum dimension and containing at least 40 percent by weight of material smaller than $\frac{3}{4}$ inch in size.
- 3.1.2 **Soil-rock fills** are defined as fills containing no rocks or hard lumps larger than 4 feet in maximum dimension and containing a sufficient matrix of soil fill to allow for proper compaction of soil fill around the rock fragments or hard lumps as specified in Paragraph 6.2. **Oversize rock** is defined as material greater than 12 inches.
- 3.1.3 **Rock fills** are defined as fills containing no rocks or hard lumps larger than 3 feet in maximum dimension and containing little or no fines. Fines are defined as material smaller than $\frac{3}{4}$ inch in maximum dimension. The quantity of fines shall be less than approximately 20 percent of the rock fill quantity.
- 3.2 Material of a perishable, spongy, or otherwise unsuitable nature as determined by the Consultant shall not be used in fills.
- 3.3 Materials used for fill, either imported or on-site, shall not contain hazardous materials as defined by the California Code of Regulations, Title 22, Division 4, Chapter 30, Articles 9

and 10; 40CFR; and any other applicable local, state or federal laws. The Consultant shall not be responsible for the identification or analysis of the potential presence of hazardous materials. However, if observations, odors or soil discoloration cause Consultant to suspect the presence of hazardous materials, the Consultant may request from the Owner the termination of grading operations within the affected area. Prior to resuming grading operations, the Owner shall provide a written report to the Consultant indicating that the suspected materials are not hazardous as defined by applicable laws and regulations.

- 3.4 The outer 15 feet of *soil-rock* fill slopes, measured horizontally, should be composed of properly compacted *soil* fill materials approved by the Consultant. *Rock* fill may extend to the slope face, provided that the slope is not steeper than 2:1 (horizontal:vertical) and a soil layer no thicker than 12 inches is track-walked onto the face for landscaping purposes. This procedure may be utilized provided it is acceptable to the governing agency, Owner and Consultant.
- 3.5 Samples of soil materials to be used for fill should be tested in the laboratory by the Consultant to determine the maximum density, optimum moisture content, and, where appropriate, shear strength, expansion, and gradation characteristics of the soil.
- 3.6 During grading, soil or groundwater conditions other than those identified in the Geotechnical Report may be encountered by the Contractor. The Consultant shall be notified immediately to evaluate the significance of the unanticipated condition

4. CLEARING AND PREPARING AREAS TO BE FILLED

- 4.1 Areas to be excavated and filled shall be cleared and grubbed. Clearing shall consist of complete removal above the ground surface of trees, stumps, brush, vegetation, man-made structures, and similar debris. Grubbing shall consist of removal of stumps, roots, buried logs and other unsuitable material and shall be performed in areas to be graded. Roots and other projections exceeding 1½ inches in diameter shall be removed to a depth of 3 feet below the surface of the ground. Borrow areas shall be grubbed to the extent necessary to provide suitable fill materials.
- 4.2 Asphalt pavement material removed during clearing operations should be properly disposed at an approved off-site facility or in an acceptable area of the project evaluated by Geocon and the property owner. Concrete fragments that are free of reinforcing steel may be placed in fills, provided they are placed in accordance with Section 6.2 or 6.3 of this document.

- 4.3 After clearing and grubbing of organic matter and other unsuitable material, loose or porous soils shall be removed to the depth recommended in the Geotechnical Report. The depth of removal and compaction should be observed and approved by a representative of the Consultant. The exposed surface shall then be plowed or scarified to a minimum depth of 6 inches and until the surface is free from uneven features that would tend to prevent uniform compaction by the equipment to be used.
- 4.4 Where the slope ratio of the original ground is steeper than 5:1 (horizontal:vertical), or where recommended by the Consultant, the original ground should be benched in accordance with the following illustration.

TYPICAL BENCHING DETAIL

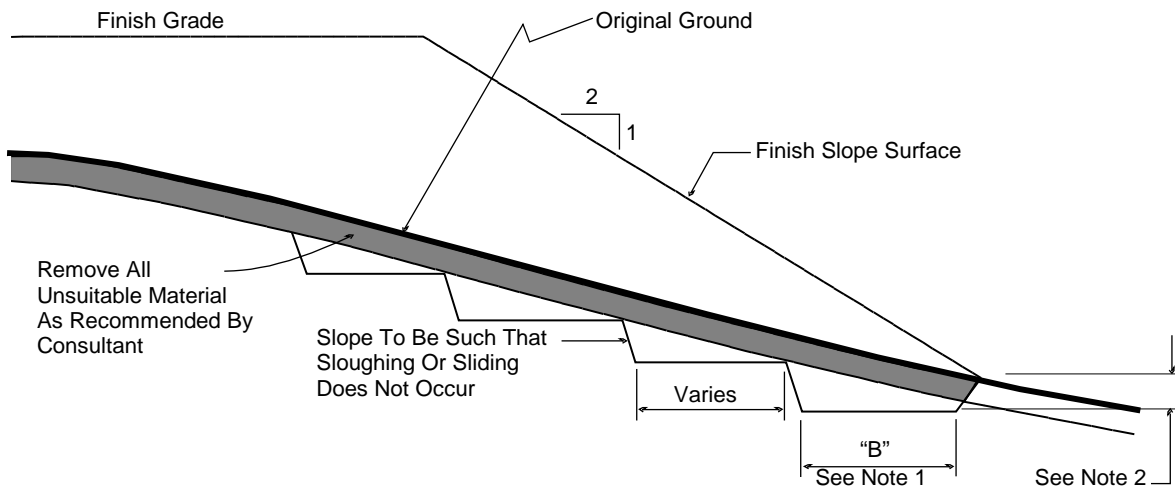

No Scale

- DETAIL NOTES: (1) Key width "B" should be a minimum of 10 feet, or sufficiently wide to permit complete coverage with the compaction equipment used. The base of the key should be graded horizontal, or inclined slightly into the natural slope.
- (2) The outside of the key should be below the topsoil or unsuitable surficial material and at least 2 feet into dense formational material. Where hard rock is exposed in the bottom of the key, the depth and configuration of the key may be modified as approved by the Consultant.

- 4.5 After areas to receive fill have been cleared and scarified, the surface should be moisture conditioned to achieve the proper moisture content, and compacted as recommended in Section 6 of these specifications.

5. COMPACTION EQUIPMENT

- 5.1 Compaction of *soil* or *soil-rock* fill shall be accomplished by sheepsfoot or segmented-steel wheeled rollers, vibratory rollers, multiple-wheel pneumatic-tired rollers, or other types of acceptable compaction equipment. Equipment shall be of such a design that it will be capable of compacting the *soil* or *soil-rock* fill to the specified relative compaction at the specified moisture content.
- 5.2 Compaction of *rock* fills shall be performed in accordance with Section 6.3.

6. PLACING, SPREADING AND COMPACTION OF FILL MATERIAL

- 6.1 *Soil* fill, as defined in Paragraph 3.1.1, shall be placed by the Contractor in accordance with the following recommendations:
- 6.1.1 *Soil* fill shall be placed by the Contractor in layers that, when compacted, should generally not exceed 8 inches. Each layer shall be spread evenly and shall be thoroughly mixed during spreading to obtain uniformity of material and moisture in each layer. The entire fill shall be constructed as a unit in nearly level lifts. Rock materials greater than 12 inches in maximum dimension shall be placed in accordance with Section 6.2 or 6.3 of these specifications.
- 6.1.2 In general, the *soil* fill shall be compacted at a moisture content at or above the optimum moisture content as determined by ASTM D 1557.
- 6.1.3 When the moisture content of *soil* fill is below that specified by the Consultant, water shall be added by the Contractor until the moisture content is in the range specified.
- 6.1.4 When the moisture content of the *soil* fill is above the range specified by the Consultant or too wet to achieve proper compaction, the *soil* fill shall be aerated by the Contractor by blading/mixing, or other satisfactory methods until the moisture content is within the range specified.
- 6.1.5 After each layer has been placed, mixed, and spread evenly, it shall be thoroughly compacted by the Contractor to a relative compaction of at least 90 percent. Relative compaction is defined as the ratio (expressed in percent) of the in-place dry density of the compacted fill to the maximum laboratory dry density as determined in accordance with ASTM D 1557. Compaction shall be continuous over the entire area, and compaction equipment shall make sufficient passes so that the specified minimum relative compaction has been achieved throughout the entire fill.

- 6.1.6 Where practical, soils having an Expansion Index greater than 50 should be placed at least 3 feet below finish pad grade and should be compacted at a moisture content generally 2 to 4 percent greater than the optimum moisture content for the material.
 - 6.1.7 Properly compacted *soil* fill shall extend to the design surface of fill slopes. To achieve proper compaction, it is recommended that fill slopes be over-built by at least 3 feet and then cut to the design grade. This procedure is considered preferable to track-walking of slopes, as described in the following paragraph.
 - 6.1.8 As an alternative to over-building of slopes, slope faces may be back-rolled with a heavy-duty loaded sheepsfoot or vibratory roller at maximum 4-foot fill height intervals. Upon completion, slopes should then be track-walked with a D-8 dozer or similar equipment, such that a dozer track covers all slope surfaces at least twice.
- 6.2 *Soil-rock* fill, as defined in Paragraph 3.1.2, shall be placed by the Contractor in accordance with the following recommendations:
- 6.2.1 Rocks larger than 12 inches but less than 4 feet in maximum dimension may be incorporated into the compacted *soil* fill, but shall be limited to the area measured 15 feet minimum horizontally from the slope face and 5 feet below finish grade or 3 feet below the deepest utility, whichever is deeper.
 - 6.2.2 Rocks or rock fragments up to 4 feet in maximum dimension may either be individually placed or placed in windrows. Under certain conditions, rocks or rock fragments up to 10 feet in maximum dimension may be placed using similar methods. The acceptability of placing rock materials greater than 4 feet in maximum dimension shall be evaluated during grading as specific cases arise and shall be approved by the Consultant prior to placement.
 - 6.2.3 For individual placement, sufficient space shall be provided between rocks to allow for passage of compaction equipment.
 - 6.2.4 For windrow placement, the rocks should be placed in trenches excavated in properly compacted *soil* fill. Trenches should be approximately 5 feet wide and 4 feet deep in maximum dimension. The voids around and beneath rocks should be filled with approved granular soil having a Sand Equivalent of 30 or greater and should be compacted by flooding. Windrows may also be placed utilizing an "open-face" method in lieu of the trench procedure, however, this method should first be approved by the Consultant.

- 6.2.5 Windrows should generally be parallel to each other and may be placed either parallel to or perpendicular to the face of the slope depending on the site geometry. The minimum horizontal spacing for windrows shall be 12 feet center-to-center with a 5-foot stagger or offset from lower courses to next overlying course. The minimum vertical spacing between windrow courses shall be 2 feet from the top of a lower windrow to the bottom of the next higher windrow.
- 6.2.6 Rock placement, fill placement and flooding of approved granular soil in the windrows should be continuously observed by the Consultant.
- 6.3 *Rock* fills, as defined in Section 3.1.3, shall be placed by the Contractor in accordance with the following recommendations:
- 6.3.1 The base of the *rock* fill shall be placed on a sloping surface (minimum slope of 2 percent). The surface shall slope toward suitable subdrainage outlet facilities. The *rock* fills shall be provided with subdrains during construction so that a hydrostatic pressure buildup does not develop. The subdrains shall be permanently connected to controlled drainage facilities to control post-construction infiltration of water.
- 6.3.2 *Rock* fills shall be placed in lifts not exceeding 3 feet. Placement shall be by rock trucks traversing previously placed lifts and dumping at the edge of the currently placed lift. Spreading of the *rock* fill shall be by dozer to facilitate *seating* of the rock. The *rock* fill shall be watered heavily during placement. Watering shall consist of water trucks traversing in front of the current rock lift face and spraying water continuously during rock placement. Compaction equipment with compactive energy comparable to or greater than that of a 20-ton steel vibratory roller or other compaction equipment providing suitable energy to achieve the required compaction or deflection as recommended in Paragraph 6.3.3 shall be utilized. The number of passes to be made should be determined as described in Paragraph 6.3.3. Once a *rock* fill lift has been covered with *soil* fill, no additional *rock* fill lifts will be permitted over the *soil* fill.
- 6.3.3 Plate bearing tests, in accordance with ASTM D 1196, may be performed in both the compacted *soil* fill and in the *rock* fill to aid in determining the required minimum number of passes of the compaction equipment. If performed, a minimum of three plate bearing tests should be performed in the properly compacted *soil* fill (minimum relative compaction of 90 percent). Plate bearing tests shall then be performed on areas of *rock* fill having two passes, four passes and six passes of the compaction equipment, respectively. The number of passes required for the *rock* fill shall be determined by comparing the results of the plate bearing tests for the *soil* fill and the *rock* fill and by evaluating the deflection

variation with number of passes. The required number of passes of the compaction equipment will be performed as necessary until the plate bearing deflections are equal to or less than that determined for the properly compacted *soil* fill. In no case will the required number of passes be less than two.

- 6.3.4 A representative of the Consultant should be present during *rock* fill operations to observe that the minimum number of “passes” have been obtained, that water is being properly applied and that specified procedures are being followed. The actual number of plate bearing tests will be determined by the Consultant during grading.
- 6.3.5 Test pits shall be excavated by the Contractor so that the Consultant can state that, in their opinion, sufficient water is present and that voids between large rocks are properly filled with smaller rock material. In-place density testing will not be required in the *rock* fills.
- 6.3.6 To reduce the potential for “piping” of fines into the *rock* fill from overlying *soil* fill material, a 2-foot layer of graded filter material shall be placed above the uppermost lift of *rock* fill. The need to place graded filter material below the *rock* should be determined by the Consultant prior to commencing grading. The gradation of the graded filter material will be determined at the time the *rock* fill is being excavated. Materials typical of the *rock* fill should be submitted to the Consultant in a timely manner, to allow design of the graded filter prior to the commencement of *rock* fill placement.
- 6.3.7 *Rock* fill placement should be continuously observed during placement by the Consultant.

7. SUBDRAINS

- 7.1 The geologic units on the site may have permeability characteristics and/or fracture systems that could be susceptible under certain conditions to seepage. The use of canyon subdrains may be necessary to mitigate the potential for adverse impacts associated with seepage conditions. Canyon subdrains with lengths in excess of 500 feet or extensions of existing offsite subdrains should use 8-inch-diameter pipes. Canyon subdrains less than 500 feet in length should use 6-inch-diameter pipes.

TYPICAL CANYON DRAIN DETAIL

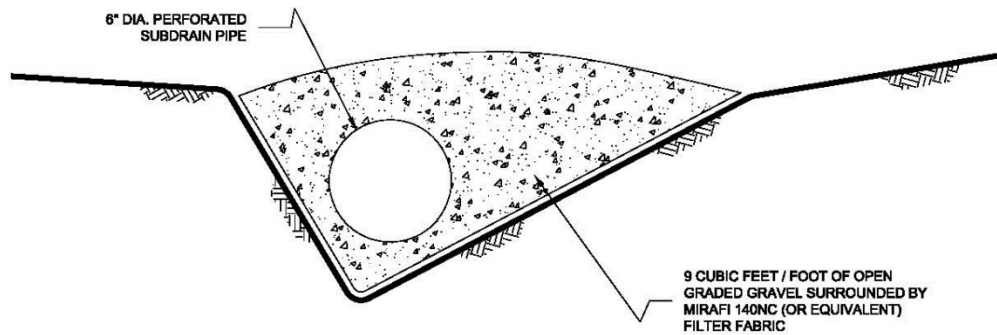
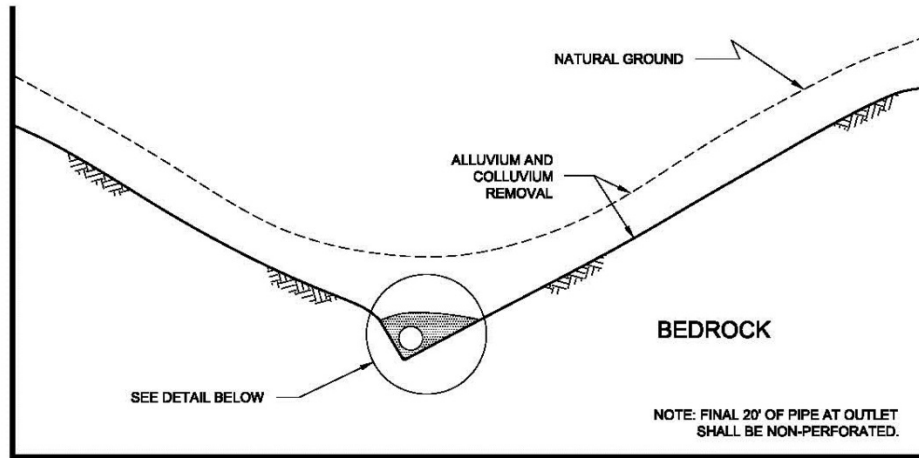

NOTES:

- 1.....8-INCH DIAMETER, SCHEDULE 80 PVC PERFORATED PIPE FOR FILLS IN EXCESS OF 100-FEET IN DEPTH OR A PIPE LENGTH OF LONGER THAN 500 FEET.
- 2.....6-INCH DIAMETER, SCHEDULE 40 PVC PERFORATED PIPE FOR FILLS LESS THAN 100-FEET IN DEPTH OR A PIPE LENGTH SHORTER THAN 500 FEET.

NO SCALE

7.2 Slope drains within stability fill keyways should use 4-inch-diameter (or larger) pipes.

TYPICAL STABILITY FILL DETAIL

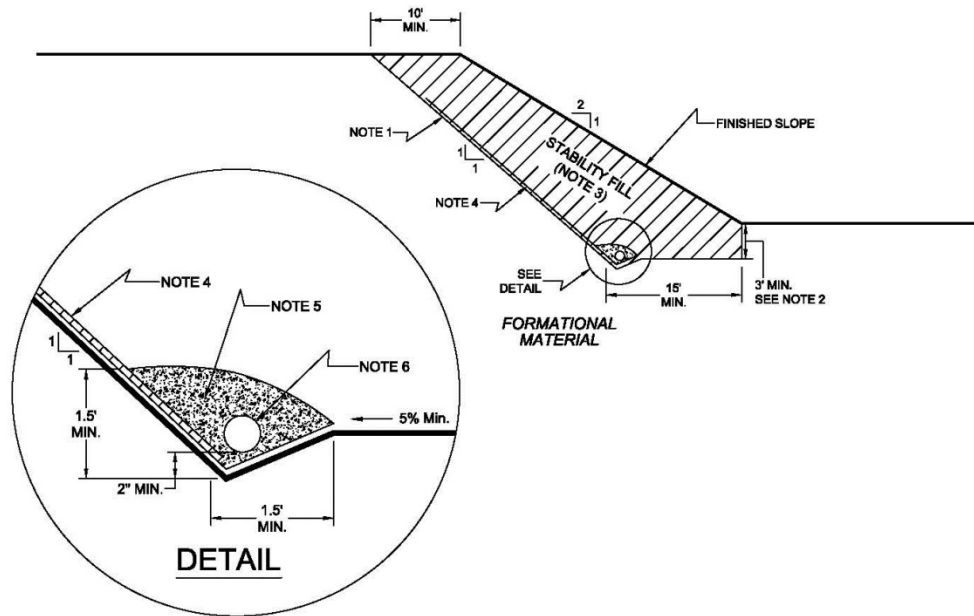

NOTES:

- 1.....EXCAVATE BACKCUT AT 1:1 INCLINATION (UNLESS OTHERWISE NOTED).
- 2.....BASE OF STABILITY FILL TO BE 3 FEET INTO FORMATIONAL MATERIAL, SLOPING A MINIMUM 5% INTO SLOPE.
- 3.....STABILITY FILL TO BE COMPOSED OF PROPERLY COMPACTED GRANULAR SOIL.
- 4.....CHIMNEY DRAINS TO BE APPROVED PREFABRICATED CHIMNEY DRAIN PANELS (MIRADRAIN G200N OR EQUIVALENT) SPACED APPROXIMATELY 20 FEET CENTER TO CENTER AND 4 FEET WIDE. CLOSER SPACING MAY BE REQUIRED IF SEEPAGE IS ENCOUNTERED.
- 5.....FILTER MATERIAL TO BE 3/4-INCH, OPEN-GRADED CRUSHED ROCK ENCLOSED IN APPROVED FILTER FABRIC (MIRAFI 140NC).
- 6.....COLLECTOR PIPE TO BE 4-INCH MINIMUM DIAMETER, PERFORATED, THICK-WALLED PVC SCHEDULE 40 OR EQUIVALENT, AND SLOPED TO DRAIN AT 1 PERCENT MINIMUM TO APPROVED OUTLET.

NO SCALE

7.3 The actual subdrain locations will be evaluated in the field during the remedial grading operations. Additional drains may be necessary depending on the conditions observed and the requirements of the local regulatory agencies. Appropriate subdrain outlets should be evaluated prior to finalizing 40-scale grading plans.

7.4 *Rock fill* or *soil-rock fill* areas may require subdrains along their down-slope perimeters to mitigate the potential for buildup of water from construction or landscape irrigation. The subdrains should be at least 6-inch-diameter pipes encapsulated in gravel and filter fabric. *Rock fill* drains should be constructed using the same requirements as canyon subdrains.

7.5 Prior to outletting, the final 20-foot segment of a subdrain that will not be extended during future development should consist of non-perforated drainpipe. At the non-perforated/perforated interface, a seepage cutoff wall should be constructed on the downslope side of the pipe.

TYPICAL CUT OFF WALL DETAIL

FRONT VIEW

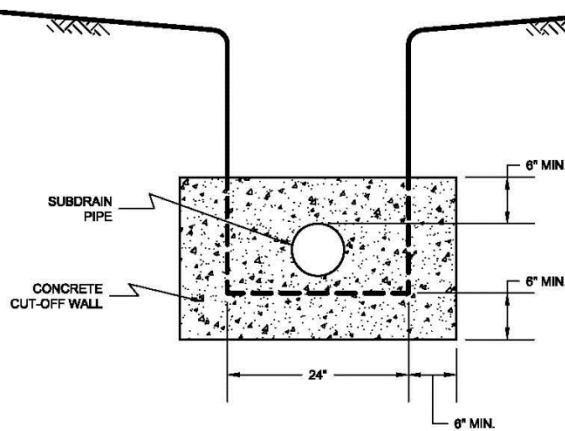

NO SCALE

SIDE VIEW

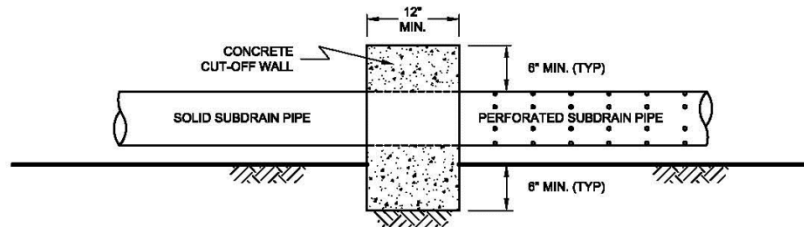

NO SCALE

7.6 Subdrains that discharge into a natural drainage course or open space area should be provided with a permanent headwall structure.

TYPICAL HEADWALL DETAIL

FRONT VIEW

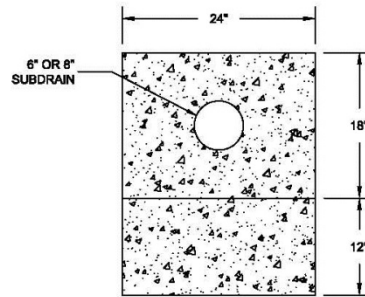

NO SCALE

SIDE VIEW

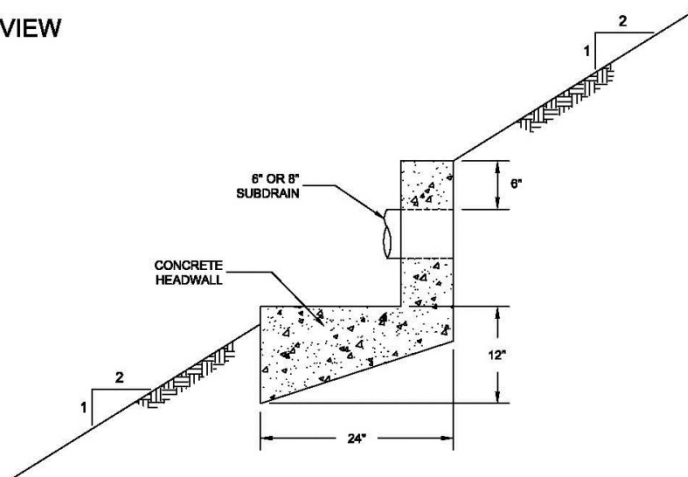

NOTE: HEADWALL SHOULD OUTLET AT TOE OF FILL SLOPE
OR INTO CONTROLLED SURFACE DRAINAGE

NO SCALE

- 7.7 The final grading plans should show the location of the proposed subdrains. After completion of remedial excavations and subdrain installation, the project civil engineer should survey the drain locations and prepare an “as-built” map showing the drain locations. The final outlet and connection locations should be determined during grading operations. Subdrains that will be extended on adjacent projects after grading can be placed on formational material and a vertical riser should be placed at the end of the subdrain. The grading contractor should consider videoing the subdrains shortly after burial to check proper installation and functionality. The contractor is responsible for the performance of the drains.

8. OBSERVATION AND TESTING

- 8.1 The Consultant shall be the Owner's representative to observe and perform tests during clearing, grubbing, filling, and compaction operations. In general, no more than 2 feet in vertical elevation of *soil* or *soil-rock* fill should be placed without at least one field density test being performed within that interval. In addition, a minimum of one field density test should be performed for every 2,000 cubic yards of *soil* or *soil-rock* fill placed and compacted.
- 8.2 The Consultant should perform a sufficient distribution of field density tests of the compacted *soil* or *soil-rock* fill to provide a basis for expressing an opinion whether the fill material is compacted as specified. Density tests shall be performed in the compacted materials below any disturbed surface. When these tests indicate that the density of any layer of fill or portion thereof is below that specified, the particular layer or areas represented by the test shall be reworked until the specified density has been achieved.
- 8.3 During placement of *rock* fill, the Consultant should observe that the minimum number of passes have been obtained per the criteria discussed in Section 6.3.3. The Consultant should request the excavation of observation pits and may perform plate bearing tests on the placed *rock* fills. The observation pits will be excavated to provide a basis for expressing an opinion as to whether the *rock* fill is properly seated and sufficient moisture has been applied to the material. When observations indicate that a layer of *rock* fill or any portion thereof is below that specified, the affected layer or area shall be reworked until the *rock* fill has been adequately seated and sufficient moisture applied.
- 8.4 A settlement monitoring program designed by the Consultant may be conducted in areas of *rock* fill placement. The specific design of the monitoring program shall be as recommended in the Conclusions and Recommendations section of the project Geotechnical Report or in the final report of testing and observation services performed during grading.
- 8.5 We should observe the placement of subdrains, to check that the drainage devices have been placed and constructed in substantial conformance with project specifications.
- 8.6 Testing procedures shall conform to the following Standards as appropriate:

8.6.1 Soil and Soil-Rock Fills:

- 8.6.1.1 Field Density Test, ASTM D 1556, *Density of Soil In-Place By the Sand-Cone Method.*

- 8.6.1.2 Field Density Test, Nuclear Method, ASTM D 6938, *Density of Soil and Soil-Aggregate In-Place by Nuclear Methods (Shallow Depth)*.
- 8.6.1.3 Laboratory Compaction Test, ASTM D 1557, *Moisture-Density Relations of Soils and Soil-Aggregate Mixtures Using 10-Pound Hammer and 18-Inch Drop*.
- 8.6.1.4. Expansion Index Test, ASTM D 4829, *Expansion Index Test*.

9. PROTECTION OF WORK

- 9.1 During construction, the Contractor shall properly grade all excavated surfaces to provide positive drainage and prevent ponding of water. Drainage of surface water shall be controlled to avoid damage to adjoining properties or to finished work on the site. The Contractor shall take remedial measures to prevent erosion of freshly graded areas until such time as permanent drainage and erosion control features have been installed. Areas subjected to erosion or sedimentation shall be properly prepared in accordance with the Specifications prior to placing additional fill or structures.
- 9.2 After completion of grading as observed and tested by the Consultant, no further excavation or filling shall be conducted except in conjunction with the services of the Consultant.

10. CERTIFICATIONS AND FINAL REPORTS

- 10.1 Upon completion of the work, Contractor shall furnish Owner a certification by the Civil Engineer stating that the lots and/or building pads are graded to within 0.1 foot vertically of elevations shown on the grading plan and that all tops and toes of slopes are within 0.5 foot horizontally of the positions shown on the grading plans. After installation of a section of subdrain, the project Civil Engineer should survey its location and prepare an *as-built* plan of the subdrain location. The project Civil Engineer should verify the proper outlet for the subdrains and the Contractor should ensure that the drain system is free of obstructions.
- 10.2 The Owner is responsible for furnishing a final as-graded soil and geologic report satisfactory to the appropriate governing or accepting agencies. The as-graded report should be prepared and signed by a California licensed Civil Engineer experienced in geotechnical engineering and by a California Certified Engineering Geologist, indicating that the geotechnical aspects of the grading were performed in substantial conformance with the Specifications or approved changes to the Specifications.

LIST OF REFERENCES

1. Boore, D. M., and G. M Atkinson (2006), Boore-Atkinson *NGA Ground Motion Relations for the Geometric Mean Horizontal Component of Peak and Spectral Ground Motion Parameters*, Report Number PEER 2007/01, May 2007.
2. Chiou, Brian S. J., and Robert R. Youngs, *A NGA Model for the Average Horizontal Component of Peak Ground Motion and Response Spectra*, preprint for article to be published in NGA Special Edition for Earthquake Spectra, Spring 2008.
3. California Department of Conservation, Division of Mines and Geology, *Probabilistic Seismic Hazard Assessment for the State of California*, Open File Report 96-08, 1996.
4. California Geological Survey, *Seismic Shaking Hazards in California*, Based on the USGS/CGS Probabilistic Seismic Hazards Assessment (PSHA) Model, 2002 (revised April 2003). 0% probability of being exceeded in 50 years.
<http://redirect.conservation.ca.gov/cgs/rghm/pshamap/pshamain.html>
5. Campbell, K. W., Y. Bozorgnia, *NGA Ground Motion Model for the Geometric Mean Horizontal Component of PGA, PGV, PGD and 5% Damped Linear Elastic Response Spectra for Periods Ranging from 0.01 to 10 s*, Preprint of version submitted for publication in the NGA Special Volume of Earthquake Spectra, Volume 24, Issue 1, pages 139-171, February 2008.
6. *Characterization of San Diego's Stadium Conglomerate For Tunnel Design*, 2001 Proceedings Rapid Excavation and Tunneling Conference, pgs. 33-45.
7. Geocon Incorporated, *Compaction Test Summary Report, Hanson Carroll Canyon Materials Plant, San Diego, California*, dated April 14, 2017 (Project No. G2070-42-01).
8. Jennings, C. W., 1994, California Division of Mines and Geology, *Fault Activity Map of California and Adjacent Areas*, California Geologic Data Map Series Map No. 6.
9. Kennedy, M. P., and S. S. Tan, 2005, *Geologic Map of the San Diego 30'x60' Quadrangle, California*, USGS Regional Map Series Map No. 3, Scale 1:100,000.
10. Risk Engineering, *EZ-FRISK*, Version 7.65.
11. Unpublished reports and maps on file with Geocon Incorporated.
12. USGS computer program, *Seismic Hazard Curves and Uniform Hazard Response Spectra*.

**UPDATE LETTER AND RESPONSE TO
GEOTECHNICAL REVIEW COMMENTS**

**3ROOTS
P.T.S. NO. 587128
SAN DIEGO, CALIFORNIA**



GEOCON
INCORPORATED

GEOTECHNICAL
ENVIRONMENTAL
MATERIALS

PREPARED FOR

**MESA COMMUNITY PARTNERS, LLC, AND
CALATLANTIC GROUP, INC.,
A DELAWARE CORPORATION
SAN DIEGO, CALIFORNIA**

**JUNE 20, 2018
PROJECT NO. G2070-42-02**



Project No. G2070-42-02
June 20, 2018

Mesa Community Partners, LLC, and
CalAtlantic Group, Inc., A Delaware Corporation
16465 Via Esprillo, Suite 150
San Diego, California 92127

Attention: Mr. Ryan Green

Subject: UPDATE LETTER AND RESPONSE TO GEOTECHNICAL REVIEW COMMENTS
3ROOTS
P.T.S. NO. 587128
SAN DIEGO, CALIFORNIA

- Reference:
1. *Compaction Test Summary Report, Hanson Carroll Canyon Materials Plant, San Diego, California*, prepared by Geocon Incorporated, dated April 14, 2017 (Project No. G2070-42-01).
 2. *Update Geotechnical Investigation for Vesting Tentative Map, 3Roots, San Diego, California*, prepared by Geocon Incorporated, dated November 10, 2017 (Project No. G2070-42-02).
 3. *Report of In-Place Density Test Results for Compaction Testing Performed From February 17, 2017 through August 7, 2017, Hanson Aggregates Pacific Southwest Region, Carroll Canyon Materials Plant – South Pit, San Diego, California*, prepared by Geocon Incorporated, dated June 4, 2018 (Project No. 01145-42-09E).

Dear Mr. Green:

This correspondence has been prepared to respond to the comments contained in the May 21, 2018, *Cycle 17 Issues*, pages 35 and 36 prepared by Mr. Jim Quinn from the City of San Diego, LDR-Geology department. Each issue along with our response is presented below.

Issue 14: *Figure 1 of the Compaction Test Summary Report, Hanson Carroll Canyon Materials Plant, San Diego, California, prepared by Geocon Inc., dated April 14, 2017 should circumscribe the limits of engineered compacted fill as part of the mine reclamation.*

Response: Figure 1 compiled the previously submitted compaction tests taken during the mine reclamation dating back to 1979. The limits of the compaction tests taken are shown on Figure 1 of Reference 1 with a solid colored line around them and represent, to the best of our knowledge, where engineered compacted fill was placed during this time.

Issue 15: *Figure 1 of the Update Letter and Response to Geotechnical Review Comments, 3Roots, P.T.S. No. 587128, San Diego, California, prepared by Geocon Inc., dated March 16, 2018 shows an area of compacted fill in the area of PA5 (Section N) that is*

not shown on Figure 1 of the Compaction Test Summary Report, Hanson Carroll Canyon Materials Plant, San Diego, California, prepared by Geocon Inc., dated April 14, 2017. Revise one of the Figures for internal consistency.

Response: Compaction testing in this area had not yet been completed when the April 2017 summary report was issued. Compaction testing specific to area PA5 has been reported in Geocon's referenced June 2018 letter (Reference 3). A copy of this report has been included in Appendix A of this response. The limits of documented compacted fill shown in Reference 2 for this area was in error. The corrected limits are shown on Figure 2 (map pocket) of this response.

Issue 16: *If there is engineering compacted fill in the area of PA5 (Section N) that was placed as part of the mine reclamation grading, provide the compaction test report for this area.*

Response: The compaction test report is included in Appendix A.

Issue 17: *Figure 1 of the Update Letter and Response to Geotechnical Review Comments, 3Roots, P.T.S. No. 587128, San Diego, California, prepared by Geocon Inc., dated March 16, 2018 is an isopach map, but it is not clear if the figure shows the thickness of engineered compacted fill or total fill thickness (documented and undocumented fill). The consultant should provide an explanation of what is shown.*

Response: The isopach map shows the thickness of documented compacted fill.

Issue 18: *Three cross sections were provided in the Update Letter and Response to Geotechnical Review Comments, 3Roots, P.T.S. No. 587128, San Diego, California, prepared by Geocon Inc., dated March 16, 2018. The cross sections query the contact shown at the bottom of the compacted fill. The consultant should clarify if this contact was observed and why it is queried.*

Response: The contact was observed. However, due to the lack of surveying data during mine reclamation grading, the bottom elevations of the compacted fill/Stadium Conglomerate contact have been queried except where verified in our exploratory borings or trenches.

Issue 19: *The project's geotechnical consultant should clarify if the engineered compacted fill was placed on subgrade that is suitable of support of the engineered compacted fill and future development without adverse settlement.*

Response: In most areas documented compacted fill was placed over Stadium Conglomerate and is suitable for the support of the proposed engineered fill and future development. In areas where documented fill was placed over compressible deposits or in areas outside of the limits of documented compacted fill where structural improvements will be constructed, all compressible surficial deposits should be removed to expose the underlying native Stadium Conglomerate bedrock and replaced as compacted fill. In non-structural areas (e.g. community park), we recommend at a minimum that the upper 5 feet of soil below existing grade in fill areas or 5 feet below finish grade in cut areas be removed and replaced as compacted fill. These recommendations are presented in our referenced report.

Issue 20: *Figures 1 and 2 of the Update Letter and Response to Geotechnical Review Comments, 3Roots, P.T.S. No. 587128, San Diego, California, prepared by Geocon Inc., dated March 16, 2018 suggest or indicate that areas 1, 2 and 3 represent pits, or*

basins filled with soil. The consultant should indicate if subdrains were installed to provide an outlet for subsurface drainage.

Response: Subdrains were not installed due to the lack of a suitable outlet location or positive drainage.

Issue 21: *If subdrains were not installed, indicate if the fill within these undrained mine pit areas will become saturated and result in adverse settlement.*

Response: We do not anticipate adverse settlement. Settlement monitoring and settlement of the existing and proposed compacted fills is discussed in Sections 8.3 and 8.7 of Reference 2. Final estimated settlement values as a result of both foundation loading and hydro-compression due to fill saturation will be provided once final grading plans are prepared.

Issue 22: *The geologic/geotechnical map(s) should encompass the entire property and off-site improvements.*

Response: We have revised the *Geologic Map*, Figure 2 in our referenced report to include the off-site improvements. A copy of the revised map is provided in the Map Pocket.

Issue 23: *Sheet 1 of the conceptual development plans indicates "maximum height of cut and fill slope(s): 92 Ft; 2:1 slope ratio with 1:5:1 cut slopes, as recommended per soils engineer". All slopes shown on the plan appear to be 2:1 (horizontal:vertical) and the note should be revised accordingly.*

Response: The civil engineer has been notified.

Issue 24: *Per San Diego Municipal Code 142.0148(b), cut and fill slopes shall be set back from the property lines (existing and proposed). Revise the plans as necessary to comply with this regulation. Check with LDR-Engineering on requirements.*

Response: The civil engineer has been notified.

If there are any questions regarding this correspondence, or if we may be of further service, please contact the undersigned at your convenience.

Very truly yours,

GEOCON INCORPORATED

Rodney C. Mikesell
GE 2533

RCM:TKR:dmc

(e-mail) Addressee



Troy K. Reist
CEG 2408





- GEOLOGIC LEGEND**
- Qudf UNCONSOLIDATED FILL (Shown Where Buried)
 - Qcf COMPACTED FILL (Shown Where Buried)
 - Qal ALLUVIUM (Shown Where Buried)
 - Qc COLLUVIUM
 - Qvop8 VERY OLD PARACLASTIC DEPOSITS
 - Tst STADIUM CONGLOMERATE (Shown Where Buried)
 - APPROX. LOCATION OF GEOLOGIC CONTACT (Shown Where Buried, Quoted Where Uncertain)
 - LB-1 APPROX. LOCATION OF LARGE DIAMETER BORING
 - LB-2 APPROX. LOCATION OF SMALL DIAMETER BORING
 - T-1 APPROX. LOCATION OF EXPLORATORY TRENCH
 - T-2 APPROX. DEPTH TO SEEPAGE/GROUNDWATER (In Feet)
 - T-3 APPROX. THICKNESS OF REMEDIAL GRADING (In Feet)
 - T-4 APPROX. ELEVATION OF CONTACT WITH STADIUM CONGLOMERATE (In Feet)
 - T-5 APPROX. ELEVATION OF TOP OF COMPACTED FILL (In Feet)
 - APPROX. LOCATION OF REACTIVE FILL (Quoted Where Buried, Quoted Where Uncertain)
 - APPROX. LOCATION OF INFILTRATION TEST
 - APPROX. LIMITS OF UNCONSOLIDATED FILL (QUIV PLACED IN POND AREAS)
 - APPROX. LIMITS OF STODOPLE
 - APPROX. AREA OF COMPACTED FILL IN POND
 - GEOLOGIC CROSS SECTION

GRAPHIC SCALE
 0' 60' 120' 180' 240' 300' 360' 480'
 SCALE 1"=120' (on 72x36")

APPENDIX

A

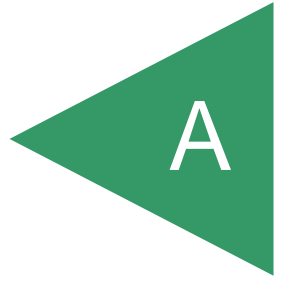



Project No. 01145-42-09E
June 4, 2018

Hanson Aggregates
Pacific Southwest Region
Post Office Box 639069
San Diego, California 92163-9069

Attention: Mr. Marvin Howell

Subject: REPORT OF IN-PLACE DENSITY TEST RESULTS FOR COMPACTION TESTING
PERFORMED FROM FEBRUARY 17, 2017 THROUGH AUGUST 7, 2017
HANSON AGGREGATES PACIFIC SOUTHWEST REGION
CARROLL CANYON MATERIALS PLANT — SOUTH PIT
SAN DIEGO, CALIFORNIA

Dear Mr. Howell:

In accordance with your request, we herein submit the results of the in-place density tests performed in Area 5 mining pit from February 17, 2017 through August 7, 2017. Tests performed previous to February 17, 2017, are summarized in earlier reports. Typical filling operations consist of spreading waste materials consisting of olive brown to orange brown, silty to clayey sand, across the relatively large previously mined pit area.

For the proceeding references, we utilized the applicable ASTM version at time of testing. We performed in-place density tests using a nuclear density gauge in accordance with ASTM Test Procedure D 6938. Test results indicate that fill materials have been compacted to at least 90 percent relative compaction with near to slightly above optimum moisture content at the locations tested. Compaction tests results are presented on Table I.

We previously collected and performed laboratory tests on samples of the material used for fill in accordance with ASTM D 1557, Maximum Dry Density and Optimum Moisture Content. Additionally, representative samples of fill were obtained and returned to our laboratory for determining compaction characteristics in accordance with ASTM D 1557, Maximum Dry Maximum Dry Density and Optimum Moisture Content. The laboratory test results were used in the field by the soil technician to assess the degree of relative compaction and moisture content. Results of the laboratory tests are presented on Table II.

Should you have questions regarding this report, or if we may be of further service, please contact the undersigned at your convenience.

Very truly yours,

GEOCON INCORPORATED

Rodney C. Mikesell
GE 2533

RCM:dmc

(e-mail) Addressee



TABLE I
SUMMARY OF FIELD DENSITY TEST RESULTS

Test No.	Date	Location	Elev. or Depth (ft)	Curve No.	Plus 3/4" Rock (%)	Adj. MDD (pcf)	Adj. OMC (%)	Field Dry Dens. (pcf)	Field Moist. Cont. (%)	Field Rel. Comp. (%)	Req'd. Rel. Comp. (%)
5226	02/17/17	50 ft NW of Belt 1502	235	48	0	132.1	8.7	122.4	9.2	93	93
5227	02/17/17	100 ft NW of Belt 1502	235	48	0	132.1	8.7	122.6	9.7	93	93
5228	02/22/17	60 ft E of Elev Mark 2059	233	48	0	132.1	8.7	116.6	6.7	88	93
5228 A	02/22/17	60 ft E of Elev Mark 2059	233	48	0	132.1	8.7	123.0	8.3	93	93
5229	02/23/17	90 ft SE of Elev Mark 2059	232	48	0	132.1	8.7	120.2	9.2	91	93
5229 A	02/23/17	90 ft SE of Elev Mark 2059	232	48	0	132.1	8.7	122.9	7.9	93	93
5230	02/24/17	80ft SW of Elev Mark 2073	233	48	0	132.1	8.7	122.5	9.5	93	93
5231	02/24/17	120 ft W of Elev Mark 2073	233	48	0	132.1	8.7	123.8	9.3	94	93
5232	02/24/17	120 ft W of Elev Mark 2073	232	48	0	132.1	8.7	122.8	8.5	93	93
5233	02/24/17	100 ft NW of Elev Mark 1503	230	48	0	132.1	8.7	124.0	7.7	94	93
5234	02/24/17	100 ft NW of Elev Mark 1503	231	48	0	132.1	8.7	123.1	7.7	93	93
5235	02/24/17	100 ft SW of Elev Mark 1503	227	48	0	132.1	8.7	122.5	8.1	93	93
5236	02/24/17	100 ft SW of Elev Mark 1503	228	48	0	132.1	8.7	122.6	8.2	93	93
5237	03/13/17	W of Elev Mark 2065	231	48	0	132.1	8.7	124.0	10.0	94	93
5238	03/13/17	100 ft NW of Elev Mark 2065	233	48	0	132.1	8.7	123.1	9.6	93	93
5239	04/04/17	150 ft SW of Elev Mark 1503	232	48	10	134.3	7.9	130.0	6.2	97	93
5239 A	04/20/17	150 ft SW of Elev Mark 1503	232	48	10	134.3	7.9	127.2	8.2	95	93
5240	04/04/17	150 ft SW of Elev Mark 1503	232	48	10	134.3	7.9	130.6	7.2	97	93
5241	04/04/17	200 ft W of Elev Mark 1504	230	48	10	134.3	7.9	125.1	6.3	93	93
5241 A	04/20/17	200 ft W of Elev Mark 1504	230	48	10	134.3	7.9	121.9	8.7	91	93
5241 B	04/20/17	200 ft W of Elev Mark 1504	230	48	10	134.3	7.9	122.8	7.8	91	93
5242	04/04/17	200 ft W of Elev Mark 1504	231	48	10	134.3	7.9	123.1	7.3	92	93
5243	04/04/17	200 ft W of Elev Mark 1504	232	48	10	134.3	7.9	128.0	5.1	95	93
5243 A	04/20/17	200 ft W of Elev Mark 1504	232	48	10	134.3	7.9	124.8	8.1	93	93
5244	04/20/17	200 ft W of Elev Mark 1504	229	48	0	132.1	8.7	117.1	10.9	89	93
5245	04/20/17	250 NW Elev Mark 1503	233	48	0	132.1	8.7	122.7	8.8	93	93
5246	05/25/17	NW Corner	230	48	0	132.1	8.7	124.5	8.6	94	93
5247	05/25/17	NW Corner	228	48	0	132.1	8.7	124.9	8.9	95	93
5248	05/26/17	NW Corner	227	48	0	132.1	8.7	122.7	8.1	93	93
5249	06/01/17	W Side	225	45	0	128.8	9.2	120.5	9.6	94	93
5250	06/01/17	W Side	228	45	0	128.8	9.2	123.6	9.0	96	93

**TABLE I
SUMMARY OF FIELD DENSITY TEST RESULTS**

Test No.	Date	Location	Elev. or Depth (ft)	Curve No.	Plus 3/4" Rock (%)	Adj. MDD (pcf)	Adj. OMC (%)	Field Dry Dens. (pcf)	Field Moist. Cont. (%)	Field Rel. Comp. (%)	Req'd. Rel. Comp. (%)
5251	06/06/17	W Side	224	45	0	128.8	9.2	120.8	9.1	94	93
5252	06/07/17	S Side	225	44	0	125.4	9.0	118.2	8.9	94	93
5253	06/07/17	S Side	226	44	0	125.4	9.0	117.5	8.5	94	93
5254	06/09/17	W Side	224	44	0	125.4	9.0	120.2	9.2	96	90
5255	06/09/17	W Side	225	44	0	125.4	9.0	119.3	10.1	95	90
5256	06/12/17	W Side	225	44	0	125.4	9.0	116.1	8.6	93	90
5257	06/13/17	W Side	225	44	0	125.4	9.0	117.0	8.8	93	90
5258	06/13/17	N Side	226	44	0	125.4	9.0	117.3	10.1	94	90
5259	06/14/17	W Side	226	45	0	128.8	9.2	120.2	8.3	93	90
5260	06/14/17	W Side	227	45	0	128.8	9.2	122.1	8.8	95	90
5261	06/15/17	W Side	229	45	0	128.8	9.2	121.9	9.7	95	90
5262	06/15/17	W Side	229	45	0	128.8	9.2	122.5	9.3	95	90
5263	06/19/17	W Side	233	45	0	128.8	9.2	121.7	8.2	94	90
5264	06/20/17	N Side of S Access Rd	230	45	0	128.8	9.2	123.5	8.3	96	90
5265	06/20/17	W Side	226	45	0	128.8	9.2	120.8	8.9	94	90
5266	07/06/17	NE Corner	234	45	0	128.8	9.2	120.3	9.7	93	90
5267	07/06/17	NE Corner	233	45	0	128.8	9.2	121.4	9.1	94	90
5268	07/06/17	NE Corner	233	45	0	128.8	9.2	119.8	8.7	93	90
5269	07/10/17	N Side	231	45	0	128.8	9.2	117.3	9.9	91	90
5270	07/10/17	N Side	233	45	0	128.8	9.2	119.1	9.4	92	90
5271	07/12/17	N Side	234	44	0	125.4	9.0	117.8	8.2	94	90
5272	07/14/17	NE Corner	233	44	0	125.4	9.0	113.8	9.2	91	90
5273	07/14/17	N Side	233	44	0	125.4	9.0	116.3	9.1	93	90
5274	07/14/17	NE Corner	234	44	0	125.4	9.0	114.2	9.5	91	90
5275	07/17/17	N Side	234	44	0	125.4	9.0	115.7	9.8	92	90
5276	07/20/17	NE Corner	234	45	0	128.8	9.2	120.0	8.5	93	90
5277	07/20/17	NE Corner	234	45	0	128.8	9.2	122.1	10.5	95	90
5278	07/24/17	NW Fill Area	233	48	0	132.1	8.7	123.9	8.1	94	90
5279	07/24/17	NW Fill Area	232	48	0	132.1	8.7	124.3	8.9	94	90
5280	07/24/17	NW Fill Area	232	48	0	132.1	8.7	123.0	8.6	93	90
5281	08/04/17	SW Fill	230	48	0	132.1	8.7	121.5	7.8	92	90

TABLE I
SUMMARY OF FIELD DENSITY TEST RESULTS

Test No.	Date	Location	Elev. or Depth (ft)	Curve No.	Plus 3/4" Rock (%)	Adj. MDD (pcf)	Adj. OMC (%)	Field Dry Dens. (pcf)	Field Moist. Cont. (%)	Field Rel. Comp. (%)	Req'd. Rel. Comp. (%)
5282	08/04/17	SW Fill	231	48	0	132.1	8.7	123.7	8.1	94	90
5283	08/07/17	SW Fill	228	48	0	132.1	8.7	123.5	8.8	93	90
5284	08/07/17	SW Fill	229	48	0	132.1	8.7	121.9	7.9	92	90

TABLE I
EXPLANATION OF CODED TERMS

- TEST SUFFIX

A, B, C, . . . : Retest of previous density test failure, following moisture conditioning and/or recompaction.

- ~~STRIKE-OUT~~

Fill in area of density test failure was removed and replaced with properly compacted fill soil.

- PREFIX CODE DESIGNATION FOR TEST NUMBERS

- CURVE NO.

Corresponds to curve numbers listed in the summary of laboratory maximum dry density and optimum moisture content test results table for selected fill soil samples encountered during testing and observation.

- ROCK CORRECTION

For density tests with rock percentage greater than zero, laboratory maximum dry density and optimum moisture content were adjusted for rock content. For tests with rock content equal to zero, laboratory maximum dry density and optimum moisture content values are unadjusted.

- TYPE OF TEST

SC: Sand Cone Test (ASTM D 1556)

NU: Nuclear Density Test (ASTM D 6938)

OT: Other

- ELEVATION/DEPTH

Test elevations/depths have been rounded to the nearest whole foot.

TABLE II
SUMMARY OF LABORATORY MAXIMUM DRY DENSITY
AND OPTIMUM MOISTURE CONTENT TEST RESULTS
ASTM D 1557

Sample No.	Description	Maximum Dry Density (pcf)	Optimum Moisture Content (% dry wt.)
44	Yellowish brown, Silty, fine to medium SAND; little gravel	125.4	9.0
45	Yellowish brown, Silty, fine to medium SAND; little gravel	128.8	9.2
48	Yellowish brown, Silty, SAND; trace clay and little gravel	132.1	8.7

**UPDATE GEOTECHNICAL REPORT
FOR VESTING TENTATIVE MAP**

**3ROOTS
SAN DIEGO, CALIFORNIA**



GEOCON
INCORPORATED

GEOTECHNICAL
ENVIRONMENTAL
MATERIALS

PREPARED FOR

**MESA COMMUNITY PARTNERS, LLC, AND
CALATLANTIC GROUP, INC.,
A DELAWARE CORPORATION
SAN DIEGO, CALIFORNIA**

**JULY 2, 2018
PROJECT NO. G2070-42-02**



Project No. G2070-42-02
July 2, 2018

Mesa Community Partners, LLC, and
CalAtlantic Group, Inc., A Delaware Corporation
16465 Via Esprillo, Suite 150
San Diego, California 92127

Attention: Mr. Ryan Green

Subject: UPDATE GEOTECHNICAL REPORT
FOR VESTING TENTATIVE MAP
3ROOTS
SAN DIEGO, CALIFORNIA

Reference: *Update Geotechnical Investigation for Vesting Tentative Map, 3Roots, San Diego, California*, prepared by Geocon Incorporated, dated November 10, 2017 (Project No. G2070-42-02).

Dear Mr. Green:

In accordance with your authorization, we have prepared this update geotechnical report for the Vesting Tentative Map (VTM) submittal for the subject project. The property is currently being graded under the reclamation grading plan per the CUP – 89-8505. Remedial grading including undocumented fill and alluvium removal to support structural improvements, as well as steep slope modification is being performed under the reclamation grading operations.

The accompanying report presents the results of our study and our conclusions and recommendations regarding geotechnical aspects of continued site development between reclamation grading and grades shown on the project VTM. It is our opinion, based on the results of this study, that the site is suitable for the planned improvements.

Should you have questions regarding this investigation, or if we may be of further service, please contact the undersigned at your convenience.

Very truly yours,

GEOCON INCORPORATED

Rodney C. Mikesell
GE 2533



Troy K. Reist
CEG 2408

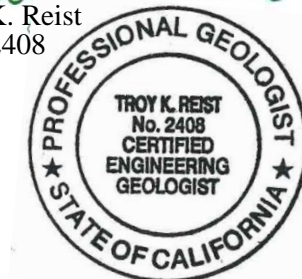

RCM:TKR:dmc

(e-mail) Addressee
(3/del) Project Design Consultants
Attention: Ms. Marina Wurst

TABLE OF CONTENTS

1.	PURPOSE AND SCOPE	1
2.	SITE DESCRIPTION AND PREVIOUS GRADING.....	1
3.	PROJECT DESCRIPTION	2
4.	SOIL AND GEOLOGIC CONDITIONS	3
4.1	Undocumented Fill (Qudf)	3
4.2	Compacted Fill (Qcf).....	3
4.3	Alluvium (Qal)	4
4.4	Colluvium (Qc).....	4
4.5	Stadium Conglomerate (Tst).....	4
5.	GROUNDWATER	4
6.	GEOLOGIC HAZARDS	5
6.1	Faulting and Seismicity	5
6.2	Ground Rupture	7
6.3	Tsunamis and Seiches.....	7
6.4	Liquefaction and Seismically Induced Settlement.....	7
6.5	Landslides.....	7
6.6	Geologic Hazard Category	7
7.	CONCLUSIONS AND RECOMMENDATIONS.....	8
7.1	General.....	8
7.2	Soil and Excavation Characteristics	8
7.3	Settlement Monitoring.....	11
7.4	Subdrains	12
7.5	Grading Recommendations	12
7.6	Slopes.....	13
7.7	Settlement of Existing and Proposed Fills.....	14
7.8	Seismic Design Criteria.....	15
7.9	Foundations	16
7.10	Slope Maintenance.....	16
7.11	Storm Water Management.....	17
7.12	Site Drainage and Moisture Protection.....	17
7.13	Grading and Foundation Plan Review	18

LIMITATIONS AND UNIFORMITY OF CONDITIONS

MAPS AND ILLUSTRATIONS

- Figure 1, Vicinity Map
- Figure 2, Geologic Map
- Figures 3 – 8, Geologic Cross-Sections
- Figure 9, Typical Settlement Monument
- Figures 10 – 12, Slope Stability Analysis

APPENDIX A

RECOMMENDED GRADING SPECIFICATIONS

LIST OF REFERENCES

UPDATE GEOTECHNICAL INVESTIGATION FOR VESTING TENTATIVE MAP

1. PURPOSE AND SCOPE

This report presents the results of our update geotechnical investigation for the Vesting Tentative Map (VTM) submittal for the 3Roots project within the former Lehigh Hanson Carroll Canyon aggregate mine. The project site is generally located to the east and northeast of the intersection of Camino Santa Fe and Carroll Canyon Road in the Mira Mesa area of San Diego, California (see *Vicinity Map*, Figure 1). The purpose of this update geotechnical investigation is to provide recommendations regarding the geotechnical aspects of developing the property for residential and commercial uses, including parks and infrastructure.

The scope of our study consisted of a review of readily available published and unpublished geologic literature and previous geotechnical reports prepared by Geocon Incorporated for the property (see List of References). Previous field exploration performed for the reclamation grading is summarized in Geocon's November 2017 report.

Site geologic conditions depicted on the *Geologic Map* (Figure 2) were plotted on an AutoCAD base map provided by Project Design Consultants. The plan depicts ground surface elevations based on flown topographic information from a December 2016 survey, reclamation grading topography from the CUP – 89-8505, geologic contacts, and finish grades based on the VTM. Geologic cross sections are provided on Figures 3 through 8 and represent our interpretation of the geologic conditions across the site.

The conclusions and recommendations presented herein are based on our analysis of the data obtained from previous exploratory field investigations, laboratory test results, review of compaction reports associated with reclamation grading which has occurred previously on the property, and our experience with similar soil and geologic conditions on this and adjacent properties.

2. SITE DESCRIPTION AND PREVIOUS GRADING

The project site consists of approximately 412 acres of partially graded and ungraded land that has been utilized to mine aggregate (predominately the cobble from the Stadium Conglomerate) to produce sand and aggregate products since the early 1950's. Active mining ceased in 2016. Mining has resulted in removal of rock and soil deposits creating deep excavations (over 100 feet), as well as relatively steep cut slopes (0.4:1 horizontal to vertical) within the northern portion of the property. The excavations were backfilled with waste materials generated during mining activities that have created relatively sharp differential fill thicknesses with abrupt near-vertical formational sidewall

contacts. Currently, a concrete batch plant and other tenants occupy portions of the property. Numerous stockpiles of soil, aggregate, and recycled products are still present on the property.

Compaction testing during placement of waste material during active mining has been performed by Geocon Incorporated on a periodic basis between December 1979 and August 2017. Compaction reports were prepared on an approximate quarterly to annual basis during fill placement. These reports were recently summarized in Geocon's referenced April 14, 2017 summary report (see *List of References*). The summary report includes the previously submitted compaction test reports and approximate locations of the density tests taken. A subsequent report prepared by Geocon Incorporated (Geocon, June 2018) was submitted to document compaction testing performed between February 2017 and August 2017 in the PA-5 area of the project.

Reclamation activities have begun to satisfy the conditional use permit (CUP). These activities include remedial grading of undocumented fill and alluvium within proposed structural improvement areas, grading to recontour the site, widen Carroll Canyon Creek, flatten perimeter steep slopes, and prepare the land for development. Reclamation grading will result in fill depths that range from approximately 50 feet to 100 feet within the northwest portion of the property. Within the southern portion of the site, compacted fill depths are expected to range between approximately 20 and 60 feet thick. Reclamation grading will also establish all perimeter slopes at their final configuration in compliance with ESL standards.

3. PROJECT DESCRIPTION

Based on planned finish grades, VTM grading will result in fills up to approximately 30 feet above reclamation grade to establish final grades. The area of proposed fill above approved reclamation grades is hatched on the geologic cross sections (Figures 3 through 9). In fill areas where VTM grades are below the approved reclamation grade, reclamation grading will terminate at final VTM grades.

The project will support approximately 1,800 residential units, mixed-use areas, parks, and infrastructure. The residential portion will be comprised of both single-family attached and detached products along with multi-family and affordable housing units. The planned mixed-use component is expected to consist of retail and office space with a mobility hub.

Across the southern portion of the site a 25-acre community park is planned. In addition, several passive parks will be constructed within the property. Carroll Canyon Road (a proposed 6-lane prime arterial roadway) will be extended from the current terminus west of Camino Ruiz to approximately 2,000 feet west of Camino Santa Fe. The project will also restore Carroll Canyon Creek by constructing drainage features that include a drainage channel, drop structures, and an approximately

400-foot-long arch undercrossing below Carroll Canyon Road. The project will include planting and creek enhancements including creek widening and channel alignment adjustments. A pedestrian bridge across the creek drainage is also planned. Storm water management will be handled with regional basins planned at various locations on the property.

The locations and descriptions provided herein are based on a review of available information and plans. If project details change significantly from those described herein, Geocon Incorporated should be contacted to evaluate potential impacts with respect to the site soil and geologic conditions and to determine if the proposed changes will require revision of this report.

4. SOIL AND GEOLOGIC CONDITIONS

At the completion of reclamation grading, the site will be underlain by undocumented fill, compacted fill, alluvium, colluvium, and the Stadium Conglomerate Formation. The soil and geologic units are described below. The approximate lateral extent of surficial soils and geologic formational units are shown on the *Geologic Map. Geologic Cross-Sections A-A'* through N-N' represent our interpretation of the geologic conditions across the site.

4.1 Undocumented Fill (Qudf)

Undocumented fill associated with previous mining and grading activities will be removed in developable areas. Undocumented fill will remain after reclamation grading within the park site and adjacent non-structural areas located in the southern portion of the site. The undocumented fill thickness is expected to range from a few feet to approximately 20 feet thick. Once park improvements (type and location) are known, update reports will be prepared providing remedial grading and/or foundation measures to account for the undocumented fill.

4.2 Compacted Fill (Qcf)

Compacted fill placed during reclamation grading will be present across developable areas at the completion of reclamation grading. Fill placed during previous reclamation grading is summarized in Geocon's referenced reports dated April 14, 2017 and June 4, 2018 (see *List of References*). Reports documenting the current reclamation grading operations will be provided at the completion of grading, which may be done in phases. Based on our observation and testing and exploratory borings and laboratory testing performed during our previous study, the compacted fill has a low potential for loading-induced compression and has good moisture content and density. The compacted fill is considered suitable for support of planned improvements in its existing condition. Prior to placing additional fill above reclamation grades, the upper 12 inches of the existing surface should be reprocessed by scarifying, moisture conditioning and compacted.

4.3 Alluvium (Qal)

Alluvium is present within the canyon drainage area north of the project perimeter and within the southern portion (Carroll Canyon Creek) of the site. The alluvium where observed, consists of sand, silts and clays with varying amounts of cobble. With the exception of the southwest corner of the property, portions of the 25-acre community park, and within the Carroll Canyon Creek drainage, the alluvium will be removed during reclamation grading below the residential and commercial building pads and Carroll Canyon Road alignment.

4.4 Colluvium (Qc)

Colluvium was encountered at the base and along the natural hillside along the east end of the property. The colluvium consists of loose, sandy clay with gravel and cobbles. The thickness of the colluvium could not be determined due to caving within the exploratory excavations. The colluvium within structural improvement areas will be removed during reclamation grading.

4.5 Stadium Conglomerate (Tst)

The Eocene-age Stadium Conglomerate is the predominant formational unit on the site. This unit was the primary material mined to generate aggregate. In general, the Stadium Conglomerate consists of dense to very dense, yellow to light brown, cobble conglomerate. The deposit contains a relatively high percentage of rounded cobble (up to approximately 60 percent by weight) embedded in a silty to clayey, fine to medium sand soil matrix. The cobble typically ranges in size from approximately 3 inches to 12 inches, however, boulder size clasts up to 24 inches were also encountered. The Stadium Conglomerate underlies the surficial soils on the property and is exposed on the north and south perimeter slopes. Based on the Civil plans, all perimeter slopes will be cut to the VTM grades during reclamation grading. Therefore, we do not expect cuts into the Stadium Conglomerate will be required during VTM grading, with the exception of undercutting lots where cut/fill transitions occur along the northern perimeter of the property.

The Stadium Conglomerate typically consists of *low to very low* expansive silty/clayey sands that possess good shear strength characteristics in either a natural or properly compacted condition. Cuts slopes within the Stadium Conglomerate typically possess adequate factors of safety. The Stadium Conglomerate is suitable for support of additional fill and structural loading.

5. GROUNDWATER

Groundwater was encountered in our previous borings and trenches throughout the project. Groundwater appears to be perched on the underlying Stadium Conglomerate, however, we do not expect groundwater will be encountered during VTM grading. No subdrains are required as part of the reclamation grading.

It is not uncommon for groundwater or seepage conditions to develop where none previously existed. Groundwater elevations are dependent on seasonal precipitation, irrigation, land use, among other factors, and vary as a result. Proper surface drainage will be important to future performance of the project. Reclamation plans include detention basins for collection of storm water from reclamation sheet graded pads.

6. GEOLOGIC HAZARDS

6.1 Faulting and Seismicity

Based on a review of geologic literature and experience with the soil and geologic conditions in the general area, it is our opinion that no known active or potentially active faults are located at the site.

Minor fault traces have been mapped with the northern portion of the site that traverse generally from east to west. The faults were observed during grading of the adjacent Fenton Technology Park project and during the recent mining operations. Undisturbed ferruginous mineral layers caused by long periods of weathering along the fault trace were observed along the faults. These layers are suggestive of ancient (pre-Holocene) pervasive groundwater conditions. The faults also do not extend through the Quaternary units observed on site. Based on these characteristics the faults are considered inactive.

According to the computer program *EZ-FRISK (Version 7.65)*, six known active faults are located within a search radius of 50 miles from the property. The nearest known active fault is the Newport-Inglewood/Rose Canyon Fault Zone, located approximately 6 miles west of the site. The Newport-Inglewood/Rose Canyon Fault Zone is the dominant source of potential ground motion. Earthquakes that might occur on the Newport-Inglewood/Rose Canyon Fault Zone or other faults within the southern California and northern Baja California area are potential generators of significant ground motion at the site. The estimated deterministic maximum earthquake magnitude and peak ground acceleration for the Newport-Inglewood/Rose Canyon Fault Zone are 7.5 and 0.36g, respectively. Table 6.1.1 lists the estimated maximum earthquake magnitude and peak ground acceleration for the most dominant faults in relationship to the site location. We calculated peak ground acceleration (PGA) using Boore-Atkinson (2008) NGA USGS 2008, Campbell-Bozorgnia (2008) NGA USGS 2008, and Chiou-Youngs (2007) NGA USGS 2008 acceleration-attenuation relationships.

**TABLE 6.1.1
DETERMINISTIC SPECTRA SITE PARAMETERS**

Fault Name	Distance from Site (miles)	Maximum Earthquake Magnitude (Mw)	Peak Ground Acceleration		
			Boore-Atkinson 2008 (g)	Campbell-Bozorgnia 2008 (g)	Chiou-Youngs 2007 (g)
Newport-Inglewood/Rose Canyon	6	7.5	0.31	0.28	0.36
Rose Canyon	6	6.9	0.27	0.26	0.30
Coronado Bank	20	7.4	0.19	0.13	0.16
Palos Verdes Connected	20	7.7	0.21	0.14	0.19
Elsinore	32	7.85	0.17	0.11	0.14
Earthquake Valley	39	6.8	0.10	0.06	0.06

We used the computer program *EZ-FRISK* to perform a probabilistic seismic hazard analysis. The computer program *EZ-FRISK* operates under the assumption that the occurrence rate of earthquakes on each mapped Quaternary fault is proportional to the fault slip rate. The program accounts for earthquake magnitude as a function of fault rupture length. Site acceleration estimates are made using the earthquake magnitude and distance from the site to the rupture zone. The program also accounts for uncertainty in each of following: (1) earthquake magnitude, (2) rupture length for a given magnitude, (3) location of the rupture zone, (4) maximum possible magnitude of a given earthquake, and (5) acceleration at the site from a given earthquake along each fault. By calculating the expected accelerations from considered earthquake sources, the program calculates the total average annual expected number of occurrences of site acceleration greater than a specified value. We utilized acceleration-attenuation relationships suggested by Boore-Atkinson (2008), Campbell-Bozorgnia (2008), and Chiou-Youngs (2007) in the analysis. Table 6.1.2 presents the site-specific probabilistic seismic hazard parameters including acceleration-attenuation relationships and the probability of exceedence.

**TABLE 6.1.2
PROBABILISTIC SEISMIC HAZARD PARAMETERS**

Probability of Exceedence	Peak Ground Acceleration		
	Boore-Atkinson, 2008 (g)	Campbell-Bozorgnia, 2008 (g)	Chiou-Youngs, 2008 (g)
2% in a 50 Year Period	0.47	0.40	0.46
5% in a 50 Year Period	0.34	0.29	0.33
10% in a 50 Year Period	0.26	0.22	0.24

While listing peak accelerations is useful for comparison of potential effects of fault activity in a region, other considerations are important in seismic design, including frequency and duration of motion and soil conditions underlying the site. Seismic design of the structures should be evaluated in accordance with the California Building Code (CBC) guidelines.

6.2 Ground Rupture

The risk associated with ground rupture hazard is very low due to the absence of active faults at the subject site.

6.3 Tsunamis and Seiches

The site is not located near the ocean or downstream of any large bodies of water. Therefore, the risk of tsunamis or seiches associated with the site is low.

6.4 Liquefaction and Seismically Induced Settlement

Provided removal and recompaction of undocumented fill and alluvium has been performed in structural improvement areas as recommended in previous reports covering the reclamation grading, the risk associated with soil liquefaction hazard at the site is low.

6.5 Landslides

Based on our review of published geologic maps for the site vicinity, it is our opinion landslides are not present at the property or at a location that could impact the site.

6.6 Geologic Hazard Category

Review of the 2008 *City of San Diego Seismic Safety Study, Geologic Hazards and Faults, Sheet 35*, indicates the site is mapped as Geologic Hazard Categories 51, 53, and 32. Category 51 is described as- *level mesas – underlain by terrace deposits and bedrock, nominal risk*. Category 53 is described as- *level or sloping terrain, unfavorable geologic structure, low to moderate risk*. Category 32 listed under liquefaction is described as- *low potential – fluctuating groundwater, minor drainages*. At the completion of grading, the site will be underlain by compacted fill overlying the Stadium Conglomerate Formation in structural improvement areas.

7. CONCLUSIONS AND RECOMMENDATIONS

7.1 General

- 7.1.1 No soil or geologic conditions were observed that would preclude the development of the property as presently proposed provided that the recommendations of this report are followed.
- 7.1.2 The site is underlain by undocumented fill, compacted fill, alluvium, colluvium, and the Stadium Conglomerate formation. Undocumented fill, alluvium, and colluvium within structural improvement areas will be removed during reclamation grading. At the completion of reclamation grading, undocumented fill, alluvium, and colluvium will be present within the 25-acre community park and adjacent locations outside of structural improvement areas. These areas where undocumented fill, alluvium or colluvium is left in-place should be designated as “non-structural”. Update reports with remedial grading and/or foundation recommendations should be provided for park site improvements once improvement type and locations are known.
- 7.1.3 Based on previous exploratory excavations and laboratory testing, the compacted fill placed during previous reclamation grade was observed to have relatively good moisture content and density. Consolidation curves indicate the fill has a low potential for loading induced compression. The compacted fill appears to be suitable in its present condition for support of additional fill and/or structural loading.
- 7.1.4 Fill is currently being placed and compacted during reclamation grading under the observation of Geocon Incorporated. Reports summarizing the grading and compaction testing will be provided at the completion of reclamation grading, which may occur in phases.
- 7.1.5 With the exception of possible strong seismic shaking, no significant geologic hazards were observed or are known to exist on the site that would adversely affect the site. No special seismic design considerations, other than those recommended herein, are required.
- 7.1.6 It is our opinion that the proposed development will not destabilize or result in settlement of adjacent properties.

7.2 Soil and Excavation Characteristics

- 7.2.1 Excavation of the compacted fill should be possible with moderate to heavy effort using conventional heavy-duty equipment. Excavation of the Stadium Conglomerate may require

very heavy effort with conventional heavy-duty grading equipment to excavate and may generate oversized material. We expect the Stadium Conglomerate will be encountered within overexcavations on cut-fill transition building pads. Oversized rock (rocks greater than 12 inches in dimension), if encountered, can be incorporated into deep fill areas.

7.2.2 Temporary slopes should be made in conformance with OSHA requirements. The Stadium Conglomerate can be considered Type A Soil (Type B where groundwater or seepage is encountered) in accordance with OSHA requirements. Compacted fill can be considered Type B soil (Type C where seepage is encountered). Undocumented fill, alluvium, and colluvium should be considered Type C soil.

7.2.3 It is the responsibility of the contractor and their competent person to ensure that all excavations, temporary slopes and trenches are properly constructed and maintained in accordance with applicable OSHA regulations in order to maintain safety and the stability of adjacent existing improvements.

7.2.4 In general, no special shoring requirement will be necessary if temporary excavations will be less than 4 feet high. Temporary excavations greater than 4 feet high should be laid back at an appropriate inclination. Surcharge loads should not be permitted within a distance equal to the height of the excavation from the top of the excavation. The top of the excavation should be at least 15 feet from the edge of existing improvements. Excavations steeper than those recommended or closer than 15 feet from an existing surface improvement should be shored in accordance with applicable OSHA codes and regulations.

7.2.5 Table 7.2.1 presents the allowable slope inclination for different soil types based on information presented by OSHA assuming seepage is not encountered.

**TABLE 7.2.1
ALLOWABLE SLOPE INCLINATIONS FOR TEMPORARY EXCAVATIONS
LESS THAN 20 FEET FOR UNDERGROUND CONTRACTORS**

Soil or Rock Type	On-Site Geologic Unit	Maximum Inclination (horizontal: vertical)	Maximum Slope Angle from Horizontal (degrees)
Type A	Stadium Conglomerate	¾:1	53
Type B	Properly Compacted Fill	1:1	45
Type C	Undocumented Fill and Surficial Soil	1½:1	34

7.2.6 The soil encountered in the field investigation is considered to be both “non-expansive” (expansion index [EI] of 20 or less) and “expansive” (EI greater than 20) as defined by 2016 California Building Code (CBC) Section 1803.5.3. Table 7.2.2 presents soil classifications based on the expansion index. Based on the laboratory test results, a majority of the soil encountered is expected to possess a “very low” to “medium” expansion potential.

**TABLE 7.2.2
EXPANSION CLASSIFICATION BASED ON EXPANSION INDEX**

Expansion Index (EI)	Expansion Classification	2016 CBC Expansion Classification
0 – 20	Very Low	Non-Expansive
21 – 50	Low	Expansive
51 – 90	Medium	
91 – 130	High	
Greater Than 130	Very High	

7.2.7 We performed laboratory tests on samples of the site materials during previous geotechnical investigations to evaluate the percentage of water-soluble sulfate content. Results from laboratory testing indicate the on-site soils possess “Not Applicable” (“S0”) sulfate exposure to concrete structures as defined by 2016 CBC Section 1904 and ACI 318-08 Sections 4.2 and 4.3. Table 7.2.3 presents a summary of concrete requirements set forth by 2016 CBC Section 1904 and ACI 318. Samples of near pad grade soils should be performed after the completion of grading. The presence of water-soluble sulfates is not a visually discernible characteristic; therefore, other soil samples from the site could yield different concentrations. Additionally, over time landscaping activities (i.e., addition of fertilizers and other soil nutrients) may affect the concentration.

**TABLE 7.2.3
REQUIREMENTS FOR CONCRETE EXPOSED TO
SULFATE-CONTAINING SOLUTIONS**

Sulfate Exposure	Exposure Class	Water-Soluble Sulfate Percent by Weight	Cement Type	Maximum Water to Cement Ratio by Weight	Minimum Compressive Strength (psi)
Not Applicable	S0	0.00-0.10	--	--	2,500
Moderate	S1	0.10-0.20	II	0.50	4,000
Severe	S2	0.20-2.00	V	0.45	4,500
Very Severe	S3	> 2.00	V+Pozzolan or Slag	0.45	4,500

7.2.8 Based on our experience with the on-site soils, we expect the soils to be corrosive to buried metal. The corrosive nature of the soils should be considered in the design of buried metal pipes and underground structures. We performed laboratory tests during previous geotechnical studies on samples of selected samples to check the corrosion potential. A site is considered corrosive if the chloride concentration is 500 parts per million (ppm) or greater, sulfate concentration is 2,000 ppm (0.2%) or greater, or the pH is 5.5 or less according to Caltrans *Corrosion Guidelines*, dated September 2003. The laboratory test results are presented in Appendix B of our referenced report dated November 10, 2017. Based on the laboratory test results and guidelines listed above, it is our opinion the site is considered corrosive with respect to buried metals.

7.2.9 Geocon Incorporated does not practice in the field of corrosion engineering; therefore, further evaluation by a corrosion engineer may be needed to incorporate the necessary precautions to avoid premature corrosion of underground pipes and buried metal in direct contact with soil.

7.3 Settlement Monitoring

7.3.1 Settlement monitoring is recommended within areas where additional fill exceeds 50 feet. Fills placed during VTM grading are expected to be less than 30 feet. However, in PA-5 area, additional fill (recent reclamation grading plus VTM grading) will be approximately 80 feet thick. Settlement monitoring in this area should be performed once VTM grades are reached. The locations of settlement monuments will be determined once 40-scale grading plans are available.

7.3.2 Removal and compaction of compressible soils (i.e. undocumented fill, alluvium, and colluvium) within all structural improvement areas will be performed during reclamation grading. As such, adverse settlement associated with compressible deposits will be mitigated where these soils are completely removed. If groundwater is encountered, removal of the surficial soils may be limited. Where complete removals cannot be performed, settlement monitoring as discussed herein may be required. Recommendations for settlement monitoring for these conditions, if present, can be provided during VTM grading.

7.3.3 Figure 9 shows a typical settlement monument. We recommend surface settlement monuments be installed and monitored until the readings indicate settlement, as a result of fill placement, is essentially complete. Settlement monuments should be surveyed on a weekly basis. We estimate a settlement period of 3 to 6 months. The surveyed results should be provided to Geocon Incorporated to evaluate when settlement has essentially ceased.

7.4 Subdrains

7.4.1 Canyon subdrains are not required for the project.

7.5 Grading Recommendations

7.5.1 All grading should be performed in accordance with the *Recommended Grading Specifications* contained in Appendix A. Where the recommendations of this section conflict with those of Appendix A, **the recommendations of this section take precedence**. All earthwork should be observed and all fill tested for proper compaction by Geocon Incorporated.

7.5.2 Prior to commencing grading, a preconstruction conference should be held at the site with the owner or developer, grading contractor, civil engineer, City of San Diego representatives, and geotechnical engineer in attendance. Special soil handling and/or the grading plans can be discussed at that time.

7.5.3 Site preparation should begin with the removal of all deleterious material and vegetation. The depth of removal should be such that material exposed in cut and fill areas, or soils to be used as fill are relatively free of organic matter. Material generated during stripping should be exported from the site.

7.5.4 The upper surface elevation of documented compacted fill placed during previous reclamation grading (Reference No. 7) was not surveyed. As such, the elevation at the top of documented fill is unknown. The estimated contact is shown on the *Geologic Cross Sections*. Recommendations were provided in our referenced report dated November 10, 2017, to remove and recompact the upper 5 feet of fill below proposed finish grade in cut and fill areas in all structural improvement areas. In areas where this does not occur during reclamation grading, the removals should be performed during VTM grading prior to placing additional fill in fill areas, or at finish grade elevation in cut areas. Further evaluation and testing of the fill material will be performed during grading to determine the actual extent of remedial grading necessary for these areas.

7.5.5 Portions of the 25-acre community park site along the south side of the project will be underlain by undocumented fill and alluvium at the completion of grading. Remedial grading and foundation recommendations for support of structural improvements in the park can be provided in update reports once the location and type of structural improvements for the park are known.

- 7.5.6 Cut/fill transitions may occur as a result of grading within portions of the property. Additionally, lots with very large differential fill thicknesses (over 20 feet) occur near the previous mined Stadium Conglomerate sidewalls in the northwest portion of the property. To reduce the amount of differential settlement, building pads and lots should be undercut a minimum of 3 feet and sloped 1 percent to the adjacent street or deepest fill. Where the thickness of the fill below the building pad or lot exceeds 15 feet, the depth of the undercut should be increased to one-fifth of the maximum fill thickness. Building pads and lots requiring undercuts can be determined once 40-scale grading plans have been prepared.
- 7.5.7 Prior to placing fill, the base of excavations and surface of compacted fill should be scarified; moisture conditioned as necessary and compacted. Fill soils may then be placed and compacted in layers to the design finish grade elevations. In general, on-site soils are suitable for re-use as fill if free from vegetation, debris and other deleterious material. Layers of fill should be no thicker than will allow for adequate bonding and compaction. All fill, including scarified ground surfaces and backfill, should be compacted to at least 90 percent of laboratory maximum dry density as determined by ASTM Test Procedure D 1557 at or slightly above optimum moisture content. Overly wet materials, if encountered, will require drying and/or mixing with drier soils to facilitate proper compaction.
- 7.5.8 The upper 3 feet of fill on all lots and streets should be composed of properly compacted *very low to low* expansive soils. Highly expansive soils, if encountered, should be placed in deeper fill areas and properly compacted. *Very low to low* expansive soils are defined as those soils that have an Expansion Index of 50 or less. Boulders, concretions, concrete chunks greater than 12 inches in maximum dimension should not be placed within 5 feet of finish grade or 3 feet from the deepest utility within streets. Specific recommendations for the placement of oversize rock is contained in the *Grading Specifications* contained in Appendix A.
- 7.5.9 Import fill (if necessary) should consist of granular materials with a *very low to low* expansion potential (EI of 50 or less), be free of deleterious material or stones larger than 3 inches, and should be compacted as recommended herein. Geocon Incorporated should be notified of the import soil source and should be authorized to perform laboratory testing of import soil prior to its arrival at the site to evaluate its suitability as fill material. At this time imported fill is not expected to be needed to complete VTM grading.

7.6 Slopes

- 7.6.1 Slope stability analyses were performed on cut and fill slopes for slope heights up to 100 feet and 60 feet, respectively. The stability analyses were performed using simplified Janbu

analysis. Our analyses utilized average drained direct shear strength parameters based on laboratory tests performed for this project and our experience with similar soils. The analyses indicate native perimeter slopes and final cut and fill slopes will have calculated factors of safety in excess of 1.5 under static conditions for both deep-seated failure and shallow sloughing conditions. A summary of slope stability analyses is presented on Figures 10 through 12.

7.6.2 All cut slope excavations should be observed during grading by an engineering geologist to verify that soil and geologic conditions do not differ significantly from those anticipated.

7.6.3 The outer 15 feet (or a distance equal to the height of the slope, whichever is less) of fill slopes should be composed of properly compacted granular *soil* fill to reduce the potential for surficial sloughing. All slopes should be compacted by backrolling with a loaded sheepsfoot roller at vertical intervals not to exceed 4 feet and should be track-walked at the completion of each slope such that the fill soils are uniformly compacted to at least 90 percent relative compaction to the face of the finished sloped.

7.6.4 All slopes should be landscaped with drought-tolerant vegetation, having variable root depths and requiring minimal landscape irrigation. In addition, all slopes should be drained and properly maintained to reduce erosion.

7.7 Settlement of Existing and Proposed Fills

7.7.1 Engineered fill was placed on the property between 1979 and 2017. The deepest fills are located in the northwest portion of the site in areas that will require cuts to achieve pad grade. The current reclamation grading operations and planned VTM grading will result in approximately 80 feet of additional fill in the central portion of the site and approximately 10 to 30 feet in other areas. We expect post-grading settlement (hydro-compression) of the additional 80 feet of fill to be approximately 2 to 3 inches and approximately 1 inch for the 10 to 30-foot fills. We expect the settlement will occur over 20+ years depending on the influx of rain and irrigation water into the fill mass. This settlement will likely be linear from the time the fill is placed to the end of the settlement period. We do not expect the settlement will impact proposed utilities with proposed gradients of 1 percent or greater. Foundations will need to be designed to accommodate the anticipated post-construction settlement.

7.7.2 At the completion of grading, we expect some portions of the site will be underlain by approximately 100 feet of compacted fill placed during reclamation grading, which has occurred over the past 15 years. With respect to post-construction settlement in areas where

existing fills have been present for more than 5 years, we expect post-construction settlements as a result of hydro-compression to be on the order of 2.5 inches for fill thicknesses of approximately 100 feet.

7.7.3 Post-construction settlements for specific building pads and lots will be provided in an update report once grading plans have been prepared.

7.8 Seismic Design Criteria

7.8.1 We used the computer program *U.S. Seismic Design Maps*, provided by the USGS. Table 7.8.1 summarizes site-specific design criteria obtained from the 2016 California Building Code (CBC; Based on the 2015 International Building Code [IBC] and ASCE 7-10), Chapter 16 Structural Design, Section 1613 Earthquake Loads. The short spectral response uses a period of 0.2 second. The building structure and improvements should be designed using a Site Class D. We evaluated the Site Class based on the discussion in Section 1613.3.2 of the 2016 CBC and Table 20.3-1 of ASCE 7-10. The values presented in Table 7.8.1 are for the risk-targeted maximum considered earthquake (MCE_R).

**TABLE 7.8.1
2016 CBC SEISMIC DESIGN PARAMETERS**

Parameter	Value	2016 CBC Reference
Site Class	D	Table 1613.5.2
Spectral Response – Class B (0.2 sec), S_S	0.971 g	Figure 1613.5(3)
Spectral Response – Class B (1 sec), S_1	0.375 g	Figure 1613.5(4)
Site Coefficient, F_a	1.111	Table 1613.5.3(1)
Site Coefficient, F_v	1.651	Table 1613.5.3(2)
Maximum Considered Earthquake Spectral Response Acceleration (0.2 sec), S_{MS}	1.080 g	Section 1613.5.3 (Eqn 16-36)
Maximum Considered Earthquake Spectral Response Acceleration – (1 sec), S_{M1}	0.618 g	Section 1613.5.3 (Eqn 16-37)
5% Damped Design Spectral Response Acceleration (0.2 sec), S_{DS}	0.720 g	Section 1613.5.4 (Eqn 16-38)
5% Damped Design Spectral Response Acceleration (1 sec), S_{D1}	0.412 g	Section 1613.5.4 (Eqn 16-39)

7.8.2 Table 7.8.2 presents additional seismic design parameters for projects located in Seismic Design Categories D through F in accordance with ASCE 7-10 for the mapped maximum considered geometric mean (MCE_G).

**TABLE 7.8.2
2016 CBC SEISMIC DESIGN PARAMETERS**

Parameter	Value	ASCE 7-10 Reference
Mapped MCE_G Peak Ground Acceleration, PGA	0.387 g	Figure 22-7
Site Coefficient, F_{PGA}	1.113	Table 11.8-1
Site Class Modified MCE_G Peak Ground Acceleration, PGA_M	0.431g	Section 11.8.3 (Eqn 11.8-1)

7.8.3 Conformance to the criteria in Tables 7.8.1 and 7.8.2 for seismic design does not constitute any kind of guarantee or assurance that significant structural damage or ground failure will not occur if a maximum level earthquake occurs. The primary goal of seismic design is to protect life and not to avoid all damage, since such design may be economically prohibitive.

7.9 Foundations

7.9.1 We expect the site, at the completion of grading, will be suitable for the use of shallow post-tensioned or mat slab foundations. Foundation recommendations will be provided in an update report that would be based on proposed structures and final grading plans.

7.9.2 We expect footings may be designed for an allowable soil bearing pressure of 2,000 psf (dead plus live loads). The soil bearing pressure may be increased by 300 psf and 500 psf for each additional foot of foundation width and depth, respectively, up to a maximum allowable soil bearing pressure of 4,000 psf. The allowable bearing pressure may be increased by up to one-third when considering transient loading such as those due to wind or seismic forces.

7.9.3 Foundations will need to be designed to accommodate both static settlement as a result of building loading and hydro-compression. Estimated total and differential fill settlements for specific building pads and project areas will be provided in update reports once grading plans have been prepared.

7.10 Slope Maintenance

7.10.1 Slopes that are steeper than 3:1 (horizontal:vertical) may, under conditions which are both difficult to prevent and predict, be susceptible to near surface (surficial) slope instability. The instability is typically limited to the outer three feet of a portion of the slope and usually does not directly impact the improvements on the pad areas above or below the slope. The occurrence of surficial instability is more prevalent on fill slopes and is

generally preceded by a period of heavy rainfall, excessive irrigation, or the migration of subsurface seepage. The disturbance and/or loosening of the surficial soils, as might result from root growth, soil expansion, or excavation for irrigation lines and slope planting, may also be a significant contributing factor to surficial instability. It is, therefore, recommended that, to the maximum extent practical: (a) disturbed/loosened surficial soils be either removed or properly recompacted, (b) irrigation systems be periodically inspected and maintained to eliminate leaks and excessive irrigation, and (c) surface drains on and adjacent to slopes be periodically maintained to preclude ponding or erosion. It should be noted that although the incorporation of the above recommendations should reduce the potential for surficial slope instability, it will not eliminate the possibility, and, therefore, it may be necessary to rebuild or repair a portion of the project's slopes in the future.

7.11 Storm Water Management

7.11.1 If storm water management devices are not properly designed and constructed, there is a risk for distress to improvements and property located hydrologically down gradient or adjacent to these devices. Factors such as the amount of water being detained, its residence time, and soil permeability have an important effect on seepage transmission and the potential adverse impacts that may occur if the storm water management features are not properly designed and constructed. We have not performed a hydrogeological study at the site. If infiltration of storm water runoff into the subsurface occurs, downstream improvements may be subjected to seeps, springs, slope instability, raised groundwater, movement of foundations and slabs, or other undesirable impacts as a result of water infiltration.

7.11.2 We performed an infiltration study on the property (see Reference Nos. 8 and 9). Based on the results of our study, full and partial infiltration is considered infeasible due to the presence of deep fills and the dense nature of the Stadium Conglomerate Formation. Basins should utilize a liner to prevent infiltration from causing adverse settlement, migrating to adjacent slopes, utilities, and foundations.

7.12 Site Drainage and Moisture Protection

7.12.1 Adequate site drainage is critical to reduce the potential for differential soil movement, erosion and subsurface seepage. Under no circumstances should water be allowed to pond adjacent to footings. The site should be graded and maintained such that surface drainage is directed away from structures in accordance with 2016 CBC 1803.3 or other applicable standards. In addition, surface drainage should be directed away from the top of slopes into swales or other controlled drainage devices. Roof and pavement drainage should be directed into conduits that carry runoff away from the proposed structure.

- 7.12.2 In the case of basement walls or building walls retaining landscaping areas, a waterproofing system should be used on the wall and joints, and a Miradrain drainage panel (or similar) should be placed over the waterproofing. The project architect or civil engineer should provide detailed specifications on the plans for all waterproofing and drainage.
- 7.12.3 Underground utilities should be leak free. Utility and irrigation lines should be checked periodically for leaks, and detected leaks should be repaired promptly. Detrimental soil movement could occur if water is allowed to infiltrate the soil for prolonged periods of time.
- 7.12.4 Landscaping planters adjacent to paved areas are not recommended due to the potential for surface or irrigation water to infiltrate the pavement's subgrade and base course. We recommend that subdrains to collect excess irrigation water and transmit it to drainage structures, or impervious above-grade planter boxes be used. In addition, where landscaping is planned adjacent to the pavement, we recommend construction of a cutoff wall along the edge of the pavement that extends at least 6 inches below the bottom of the base material.

7.13 Grading and Foundation Plan Review

- 7.13.1 Geocon Incorporated should review the grading plans and foundation plans for the project prior to final design submittal to evaluate whether additional analyses and/or recommendations are required.

LIMITATIONS AND UNIFORMITY OF CONDITIONS

1. The firm that performed the geotechnical investigation for the project should be retained to provide testing and observation services during construction to provide continuity of geotechnical interpretation and to check that the recommendations presented for geotechnical aspects of site development are incorporated during site grading, construction of improvements, and excavation of foundations. If another geotechnical firm is selected to perform the testing and observation services during construction operations, that firm should prepare a letter indicating their intent to assume the responsibilities of project geotechnical engineer of record. A copy of the letter should be provided to the regulatory agency for their records. In addition, that firm should provide revised recommendations concerning the geotechnical aspects of the proposed development, or a written acknowledgement of their concurrence with the recommendations presented in our report. They should also perform additional analyses deemed necessary to assume the role of Geotechnical Engineer of Record.
2. The recommendations of this report pertain only to the site investigated and are based upon the assumption that the soil conditions do not deviate from those disclosed in the investigation. If any variations or undesirable conditions are encountered during construction, or if the proposed construction will differ from that anticipated herein, Geocon Incorporated should be notified so that supplemental recommendations can be given. The evaluation or identification of the potential presence of hazardous or corrosive materials was not part of the scope of services provided by Geocon Incorporated.
3. This report is issued with the understanding that it is the responsibility of the owner or his representative to ensure that the information and recommendations contained herein are brought to the attention of the architect and engineer for the project and incorporated into the plans, and the necessary steps are taken to see that the contractor and subcontractors carry out such recommendations in the field.
4. The findings of this report are valid as of the present date. However, changes in the conditions of a property can occur with the passage of time, whether they be due to natural processes or the works of man on this or adjacent properties. In addition, changes in applicable or appropriate standards may occur, whether they result from legislation or the broadening of knowledge. Accordingly, the findings of this report may be invalidated wholly or partially by changes outside our control. Therefore, this report is subject to review and should not be relied upon after a period of three years.

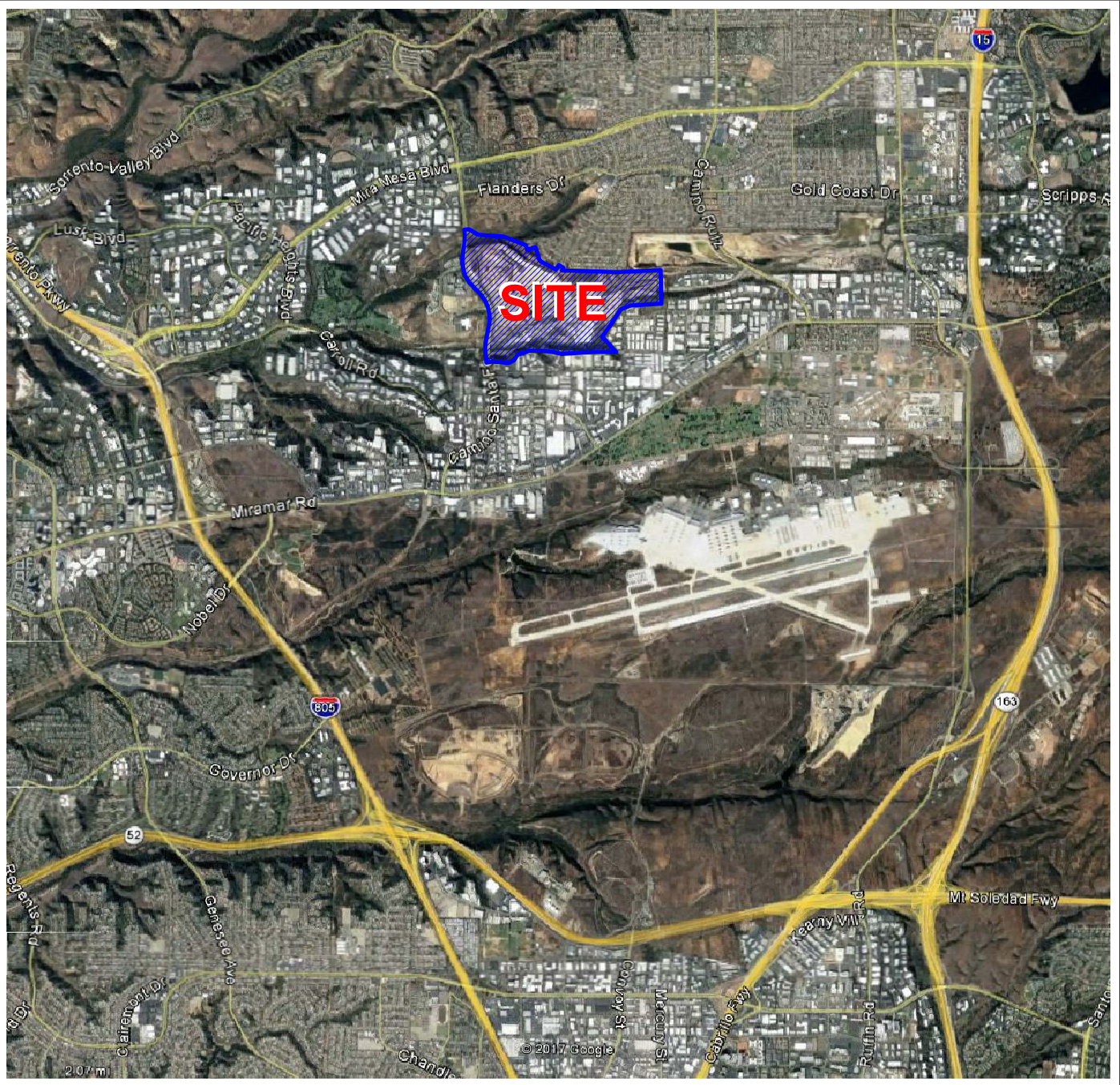

THE GEOGRAPHICAL INFORMATION MADE AVAILABLE FOR DISPLAY WAS PROVIDED BY GOOGLE EARTH, SUBJECT TO A LICENSING AGREEMENT. THE INFORMATION IS FOR ILLUSTRATIVE PURPOSES ONLY; IT IS NOT INTENDED FOR CLIENT'S USE OR RELIANCE AND SHALL NOT BE REPRODUCED BY CLIENT. CLIENT SHALL INDEMNIFY, DEFEND AND HOLD HARMLESS GEOCON FROM ANY LIABILITY INCURRED AS A RESULT OF SUCH USE OR RELIANCE BY CLIENT.



NO SCALE

VICINITY MAP

GEOCON
INCORPORATED



GEOTECHNICAL ■ ENVIRONMENTAL ■ MATERIALS
6960 FLANDERS DRIVE - SAN DIEGO, CALIFORNIA 92121 - 2974
PHONE 858 558-6900 - FAX 858 558-6159

3ROOTS - VTM
SAN DIEGO, CALIFORNIA

RM / AML	DSK/GTYPD	DATE 07 - 02 - 2018	PROJECT NO. G2070 - 42 - 02	FIG. 1
----------	-----------	---------------------	-----------------------------	--------



- GEOCON LEGEND**
- Qudf ... UNCONSOLIDATED FILL (Dotted When Buried)
 - Qcf ... COMPACTED FILL (Dotted When Buried)
 - Qal ... ALLUVIUM (Dotted When Buried)
 - Qc ... COLLUVIUM
 - Qvop8 ... VERY OLD ALLUVIAL DEPOSITS
 - Tst ... STADIUM CONGLOMERATE (Dotted When Buried)
 - ~ ... APPROX. LOCATION OF GEOSCLIC CONTACT (Dotted When Buried, Dashed When Uncertain)
 - ... APPROX. ELEVATION OF CONTACT WITH STADIUM CONGLOMERATE (in Feet)
 - ... APPROX. LOCATION OF INACTIVE FAULT (Dotted When Buried, Dashed When Uncertain)
 - ... GEOLOGIC CROSS SECTION
 - ... RECLAMATION GRADING PER CUP 88-8505

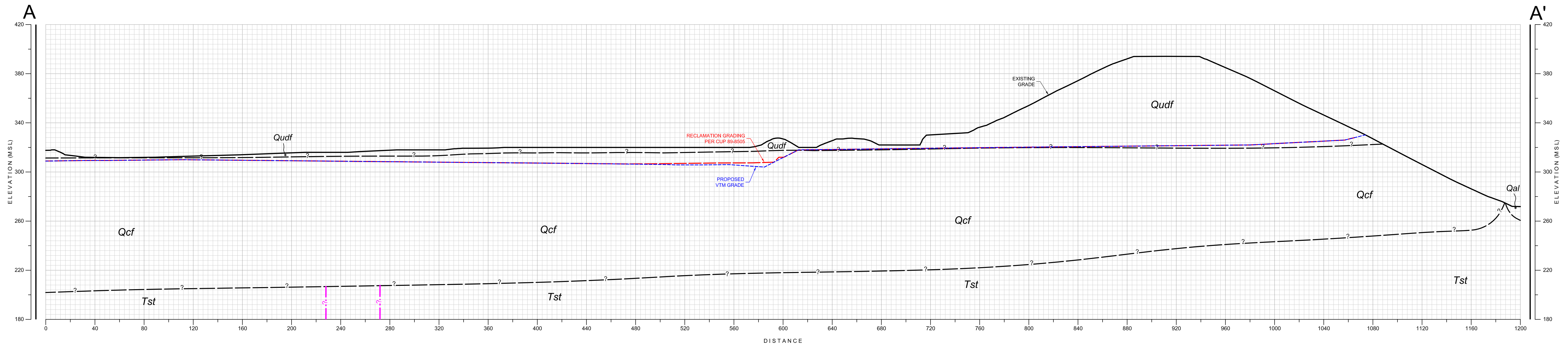

GEOLOGIC CROSS-SECTION A-A'
SCALE: 1" = 40' (Vert. = Horiz.)

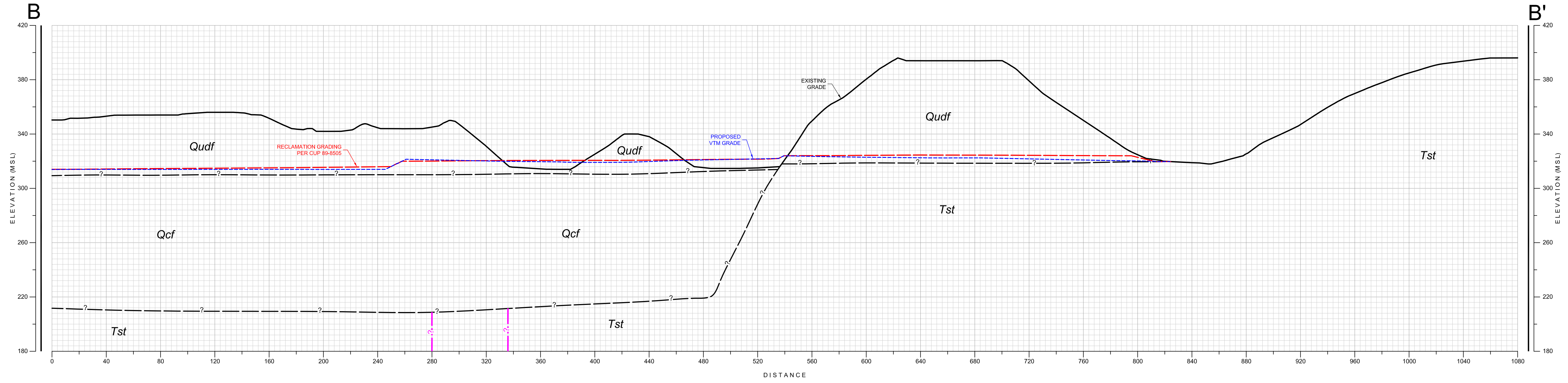

GEOLOGIC CROSS-SECTION B-B'
SCALE: 1" = 40' (Vert. = Horiz.)

- GEOCON LEGEND**
- QudfUNDOCUMENTED FILL
 - QcfCOMPACTED FILL
 - QalALLUVIUM
 - QcCOLLUVIUM
 - TstSTADIUM CONGLOMERATE
 -APPROX. LOCATION OF GEOLOGIC CONTACT
(Queried Where Uncertain)
 -APPROX. LOCATION OF INACTIVE FAULT
(Queried Where Uncertain)

GEOLOGIC CROSS SECTION		
3ROOTS - VTM SAN DIEGO, CALIFORNIA		
GEOCON INCORPORATED	SCALE 1" = 40'	DATE 07 - 02 - 2018
GEO TECHNICAL ■ ENVIRONMENTAL ■ MATERIALS 6940 TANDERS DRIVE - SAN DIEGO, CALIFORNIA 92121 - 2974 PHONE 858.558-6900 - FAX 858.558-6159	PROJECT NO. G2070 - 42 - 02	FIGURE 3
SHEET 1 OF 6		

Plotfile:0702018 11:01AM | By:ALVIN LADRILLANO | File Location:Y:\PROJECTS\G2070-42-02 (3Roots-VM) Drawings\0702018-02-02 XSection Map (Final).dwg

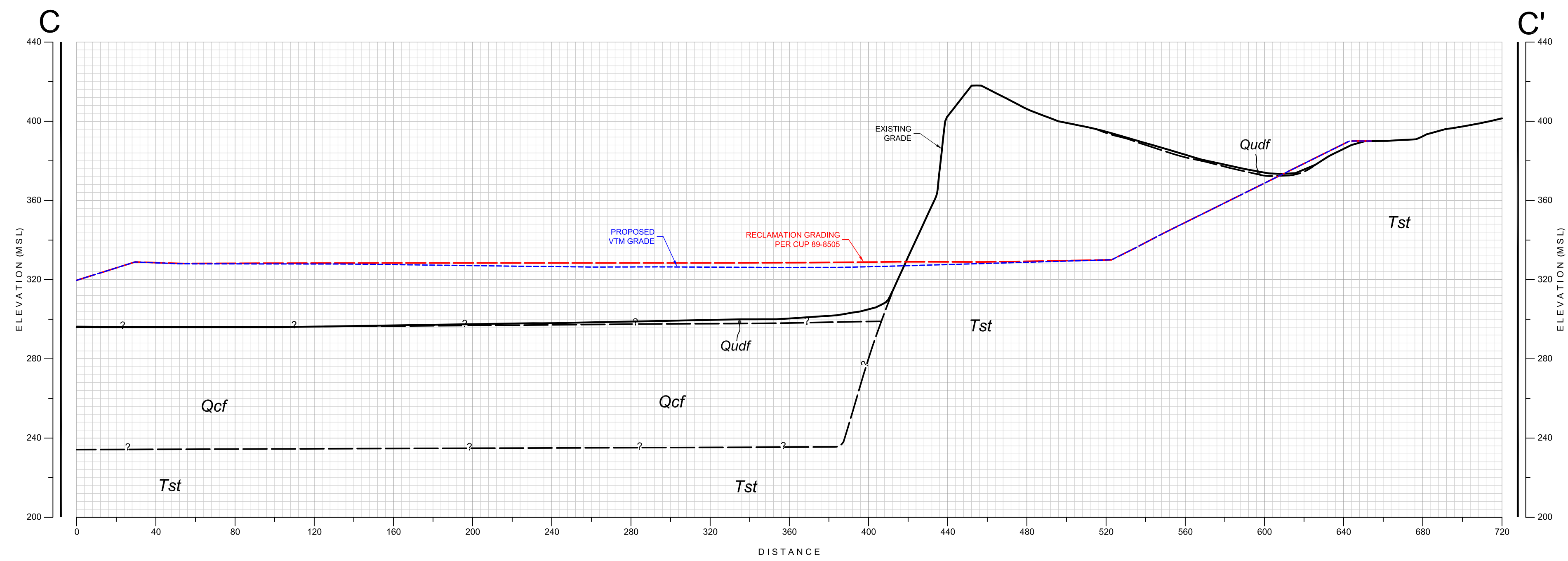

GEOLOGIC CROSS-SECTION C-C'
SCALE: 1" = 40' (Vert. = Horiz.)

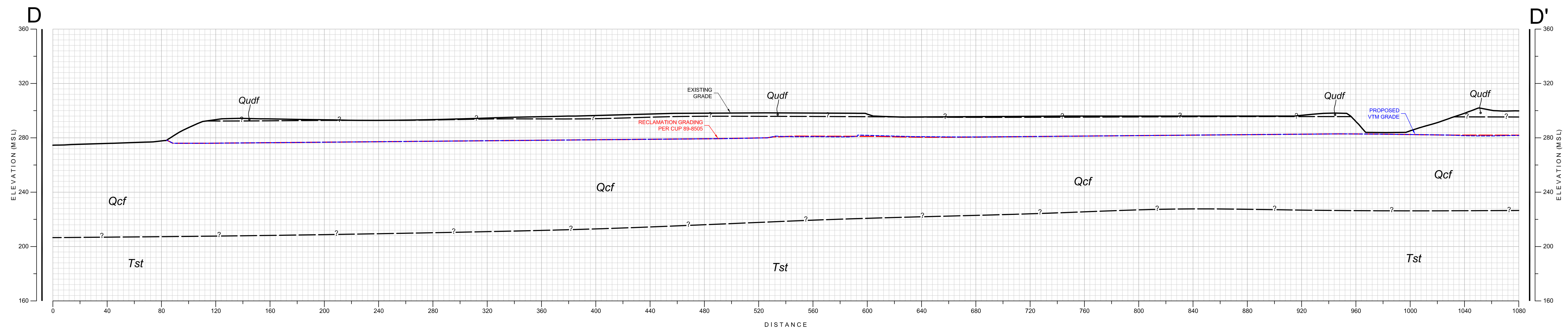

GEOLOGIC CROSS-SECTION D-D'
SCALE: 1" = 40' (Vert. = Horiz.)

- GEOCON LEGEND**
- Qudf UNDOCUMENTED FILL
 - Qcf COMPACTED FILL
 - Qal ALLUVIUM
 - Qc COLLUVIUM
 - Tst STADIUM CONGLOMERATE
 - APPROX. LOCATION OF GEOLOGIC CONTACT (Queried Where Uncertain)
 - - - - - APPROX. LOCATION OF INACTIVE FAULT (Queried Where Uncertain)

GEOLOGIC CROSS SECTION		
3ROOTS - VTM SAN DIEGO, CALIFORNIA		
GEOCON INCORPORATED	SCALE 1" = 40'	DATE 07 - 02 - 2018
GEO TECHNICAL ■ ENVIRONMENTAL ■ MATERIALS 6940 TANDERS DRIVE - SAN DIEGO, CALIFORNIA 92121 - 2974 PHONE 858.558-6900 - FAX 858.558-6159	PROJECT NO. G2070 - 42 - 02	FIGURE 4
SHEET 2 OF 6		

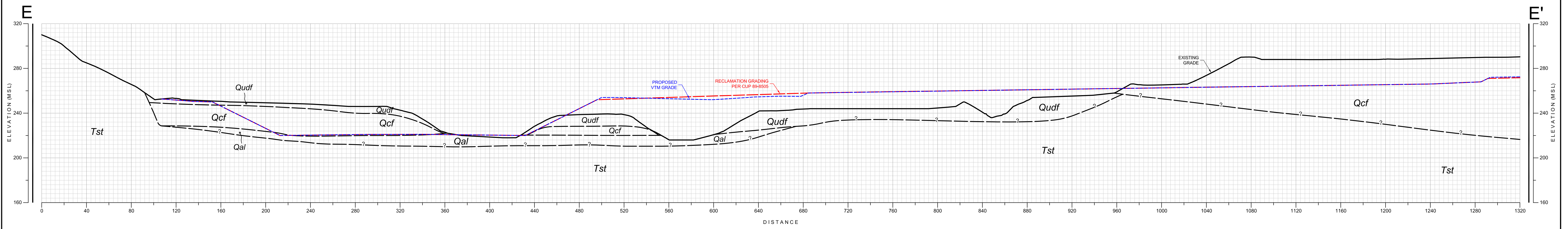

GEOLOGIC CROSS-SECTION E-E'
SCALE: 1" = 40' (Vert. = Horiz.)

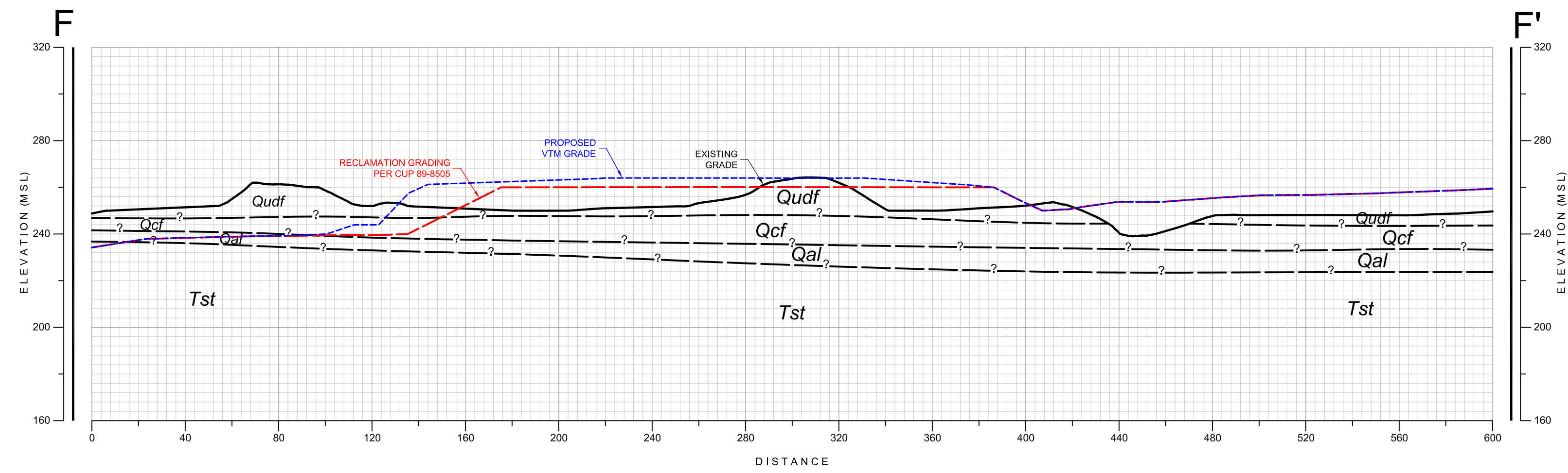

GEOLOGIC CROSS-SECTION F-F'
SCALE: 1" = 40' (Vert. = Horiz.)

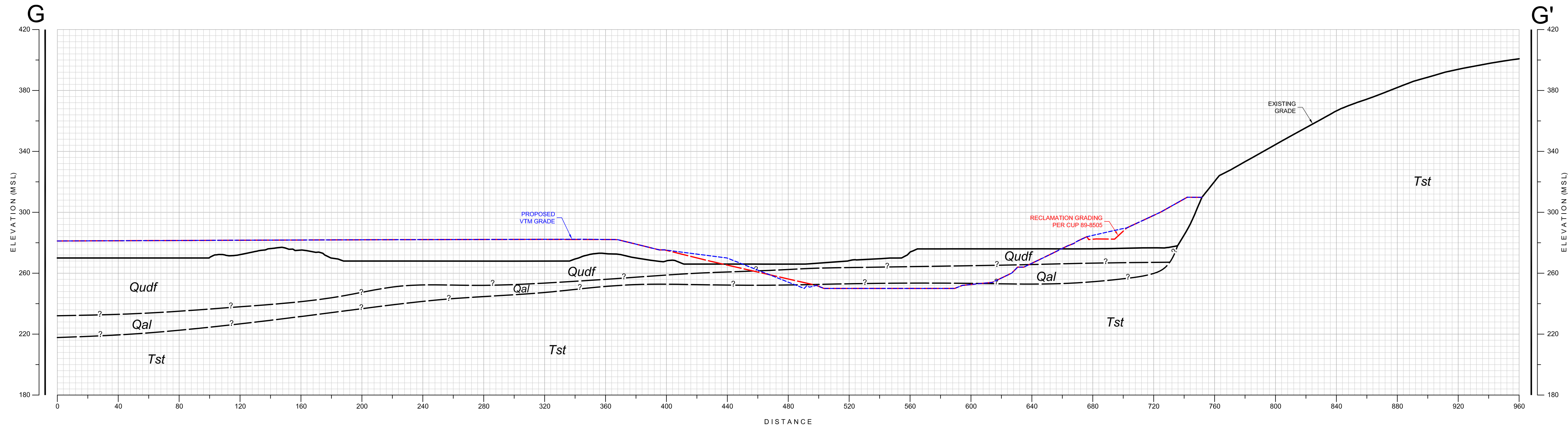

GEOLOGIC CROSS-SECTION G-G'
SCALE: 1" = 40' (Vert. = Horiz.)

- GEOCON LEGEND**
- Qudf* UNDOCUMENTED FILL
 - Qcf* COMPACTED FILL
 - Qal* ALLUVIUM
 - Qc* COLLUVIUM
 - Tst* STADIUM CONGLOMERATE
 - APPROX. LOCATION OF GEOLOGIC CONTACT (Queried Where Uncertain)
 - APPROX. LOCATION OF INACTIVE FAULT (Queried Where Uncertain)

GEOLOGIC CROSS SECTION
3ROOTS - VTM
SAN DIEGO, CALIFORNIA

GEOCON INCORPORATED GEO TECHNICAL ■ ENVIRONMENTAL ■ MATERIALS 6940 SANDERS DRIVE - SAN DIEGO, CALIFORNIA 92121-2974 PHONE 858.558-6900 - FAX 858.558-6159	SCALE 1" = 40'	DATE 07 - 02 - 2018
	PROJECT NO. G2070 - 42 - 02	FIGURE 5
	SHEET 3 OF 6	

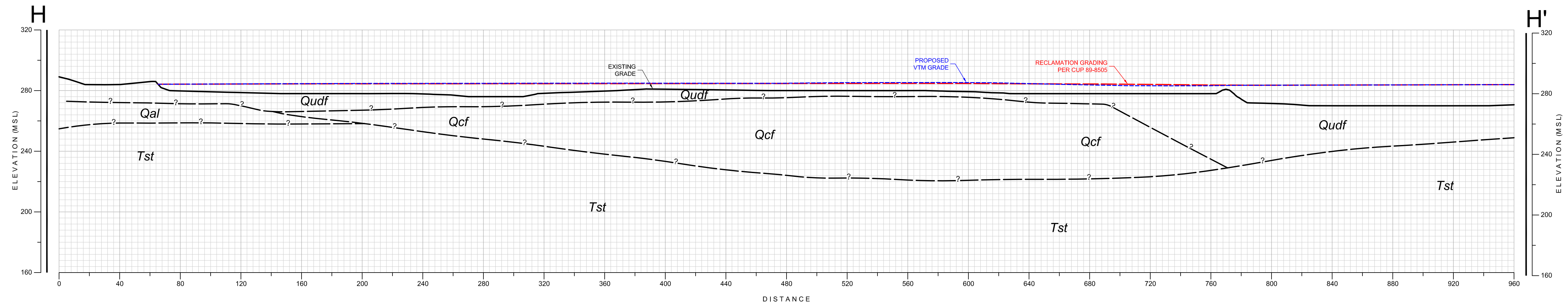

GEOLOGIC CROSS-SECTION H-H'
SCALE: 1" = 40' (Vert. = Horiz.)

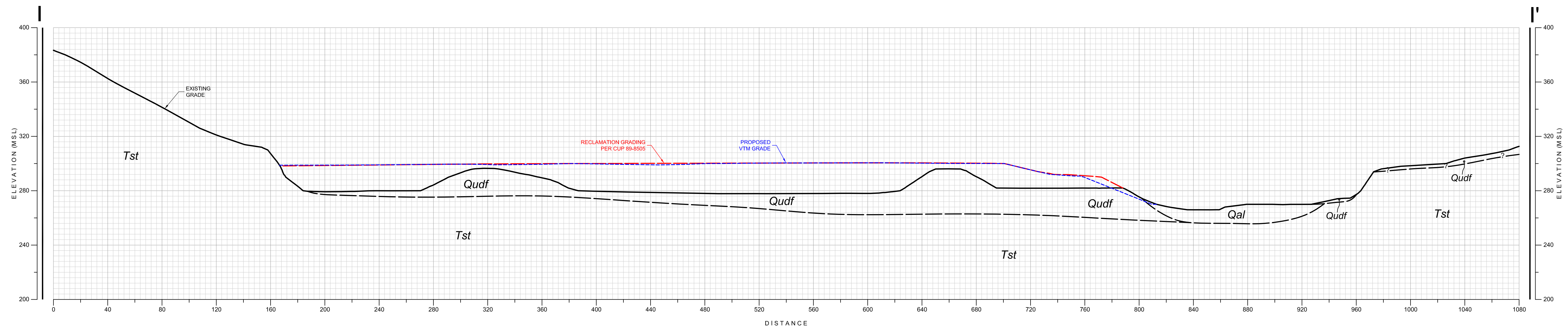

GEOLOGIC CROSS-SECTION I-I'
SCALE: 1" = 40' (Vert. = Horiz.)

- GEOCON LEGEND**
- Qudf* UNDOCUMENTED FILL
 - Qcf* COMPACTED FILL
 - Qal* ALLUVIUM
 - Qc* COLLUVIUM
 - Tst* STADIUM CONGLOMERATE
 - APPROX. LOCATION OF GEOLOGIC CONTACT
(Queried Where Uncertain)
 - APPROX. LOCATION OF INACTIVE FAULT
(Queried Where Uncertain)

GEOLOGIC CROSS SECTION		
3ROOTS - VTM SAN DIEGO, CALIFORNIA		
GEOCON INCORPORATED	SCALE 1" = 40'	DATE 07 - 02 - 2018
GEO TECHNICAL ■ ENVIRONMENTAL ■ MATERIALS 6940 ANDROSS DRIVE - SAN DIEGO, CALIFORNIA 92121 - 2974 PHONE 858.558.6900 - FAX 858.558.6159	PROJECT NO. G2070 - 42 - 02	FIGURE 6
SHEET 4 OF 6		6

Plot: 07/02/18 10:59AM | By: ALVIN LADRILLANO | File: Location\PROJECTS\G2070-42-02 (R)Roots-VTM Grading\FIGURE 6-02 Section Map (Final).dwg

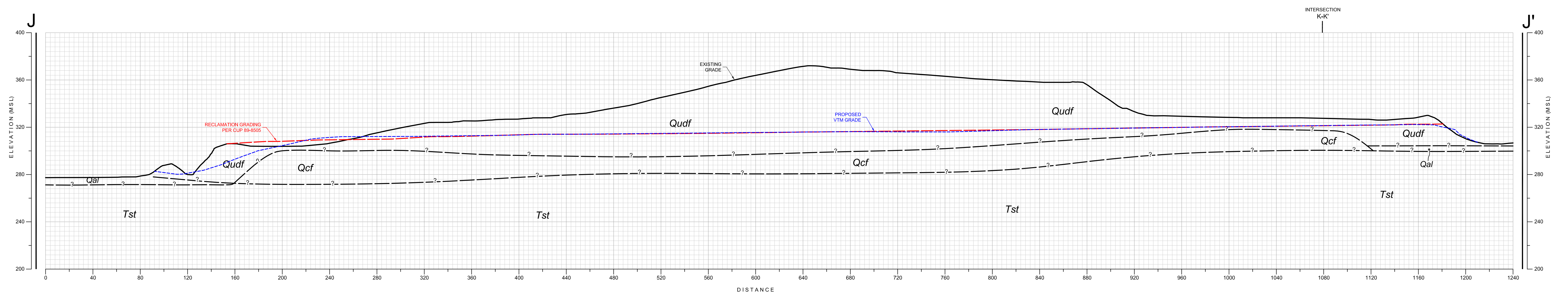

GEOLOGIC CROSS-SECTION J-J'
SCALE: 1" = 40' (Vert. = Horiz.)

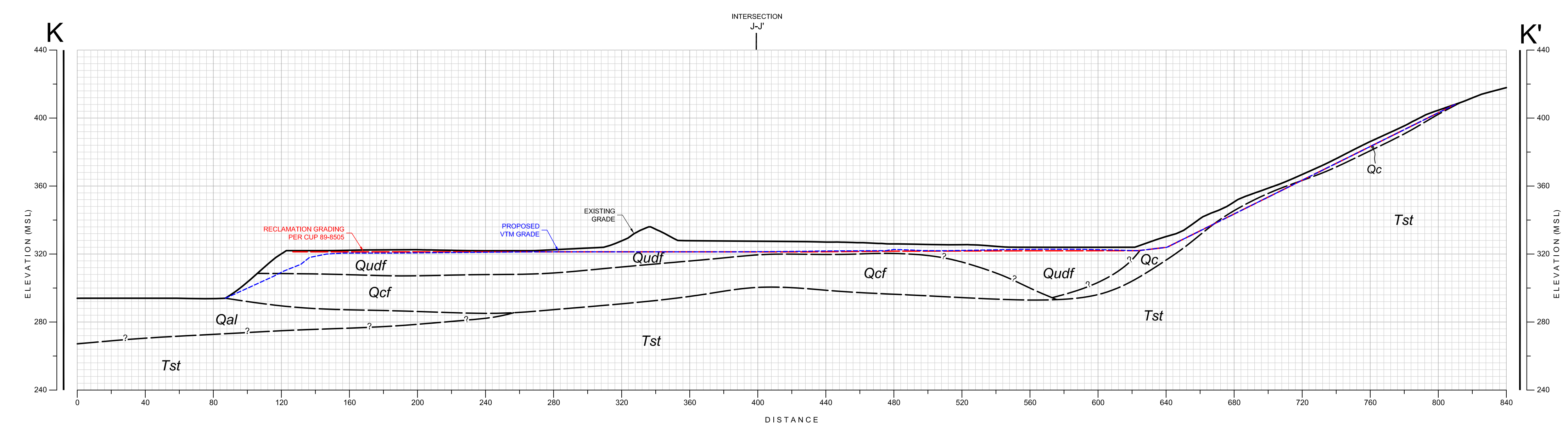

GEOLOGIC CROSS-SECTION K-K'
SCALE: 1" = 40' (Vert. = Horiz.)

- GEOCON LEGEND**
- UNDOCUMENTED FILL
 - COMPACTED FILL
 - ALLUVIUM
 - COLLUVIUM
 - STADIUM CONGLOMERATE
 - APPROX. LOCATION OF GEOLOGIC CONTACT (Queried Where Uncertain)
 - APPROX. LOCATION OF INACTIVE FAULT (Queried Where Uncertain)

GEOLOGIC CROSS SECTION		
3ROOTS - VTM SAN DIEGO, CALIFORNIA		
GEOCON <small>INCORPORATED</small> GEOTECHNICAL ■ ENVIRONMENTAL ■ MATERIALS 6940 SANDERS DRIVE - SAN DIEGO, CALIFORNIA 92121-2974 PHONE 858.558-6900 - FAX 858.558-6159	SCALE 1" = 40' PROJECT NO. G2070 - 42 - 02 SHEET 5 OF 6	DATE 07 - 02 - 2018 FIGURE 7

PlotDate: 07/02/2018 10:57AM | By: ALVIN LADRILLANO | File Location: Y:\PROJECTS\G2070-42-02 (3Roots-FTM VTM Grading)\SHEETS\G2070-42-02 XSection Map (Final).dwg

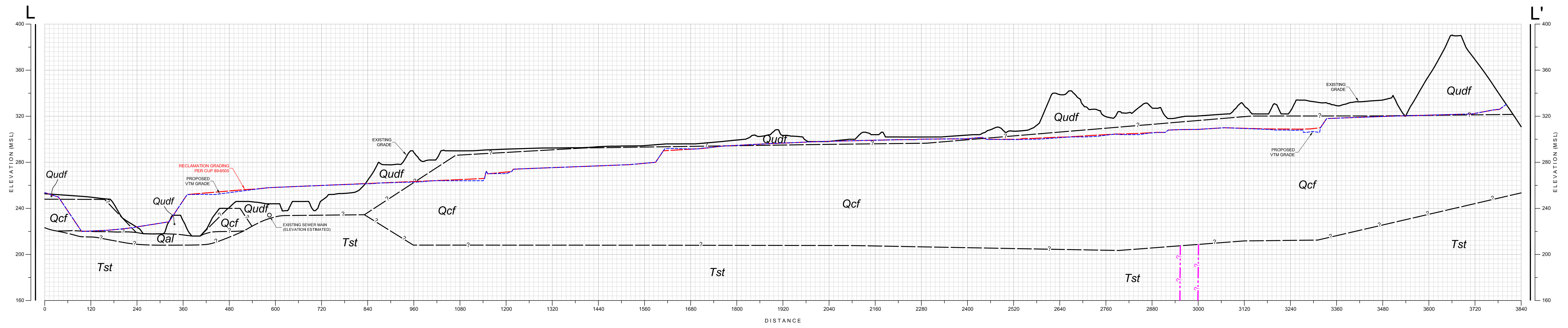

GEOLOGIC CROSS-SECTION L-L'
 SCALE
 VERTICAL: 1" = 40'
 HORIZONTAL: 1" = 120'

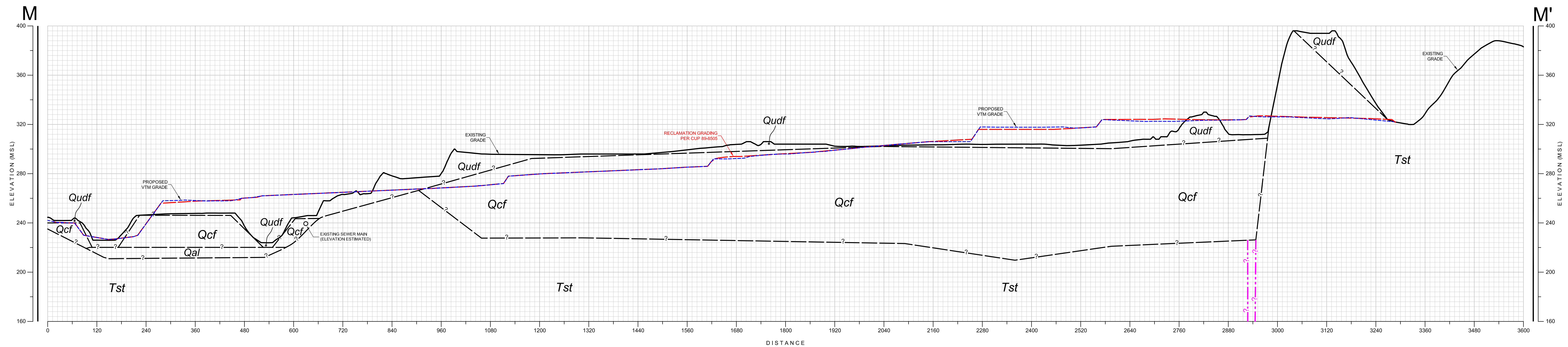

GEOLOGIC CROSS-SECTION M-M'
 SCALE
 VERTICAL: 1" = 40'
 HORIZONTAL: 1" = 120'

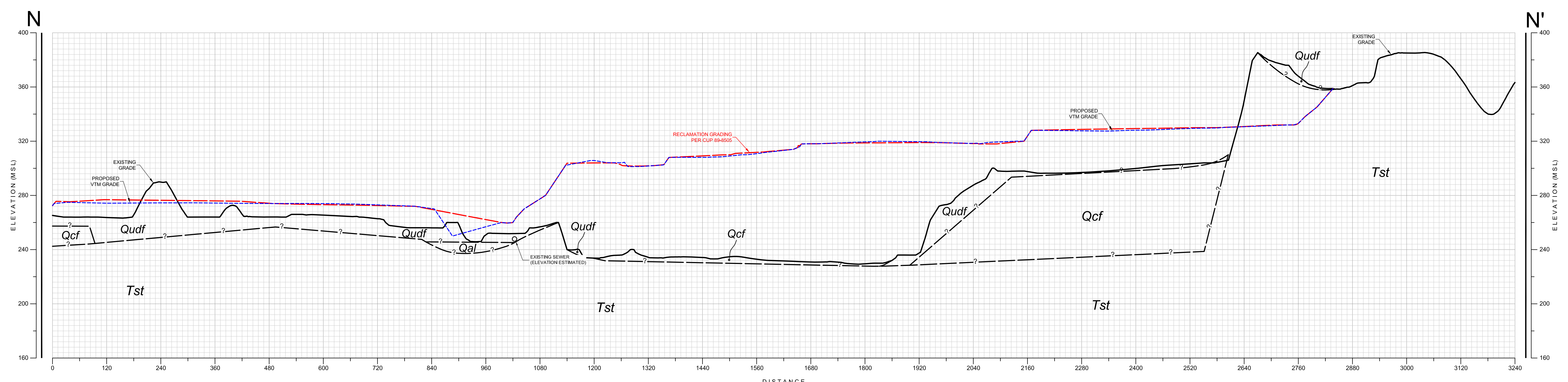

GEOLOGIC CROSS-SECTION N-N'
 SCALE
 VERTICAL: 1" = 40'
 HORIZONTAL: 1" = 120'

- GEOLOGIC LEGEND**
- Qudf UNDOCUMENTED FILL
 - Qcf COMPACTED FILL
 - Qal ALLUVIUM
 - Tst STADIUM CONGLOMERATE
 - APPROX. LOCATION OF GEOLOGIC CONTACT (Queried Where Uncertain)
 - APPROX. LOCATION OF INACTIVE FAULT (Queried Where Uncertain)

GEOLOGIC CROSS SECTIONS
 3ROOTS - VTM
 SAN DIEGO, CALIFORNIA

GEOCON <small>INCORPORATED</small> GEOTECHNICAL • ENVIRONMENTAL • MATERIALS 2660 FLANDERS DRIVE • SAN DIEGO, CALIFORNIA 92121 • 2974 PHONE 609 538-6900 • FAX 609 538-6197	SCALE: _____ DATE: 07 - 02 - 2018 PROJECT NO: G2070 - 42 - 02 SHEET 6 OF 6 FIGURE 8
---	--

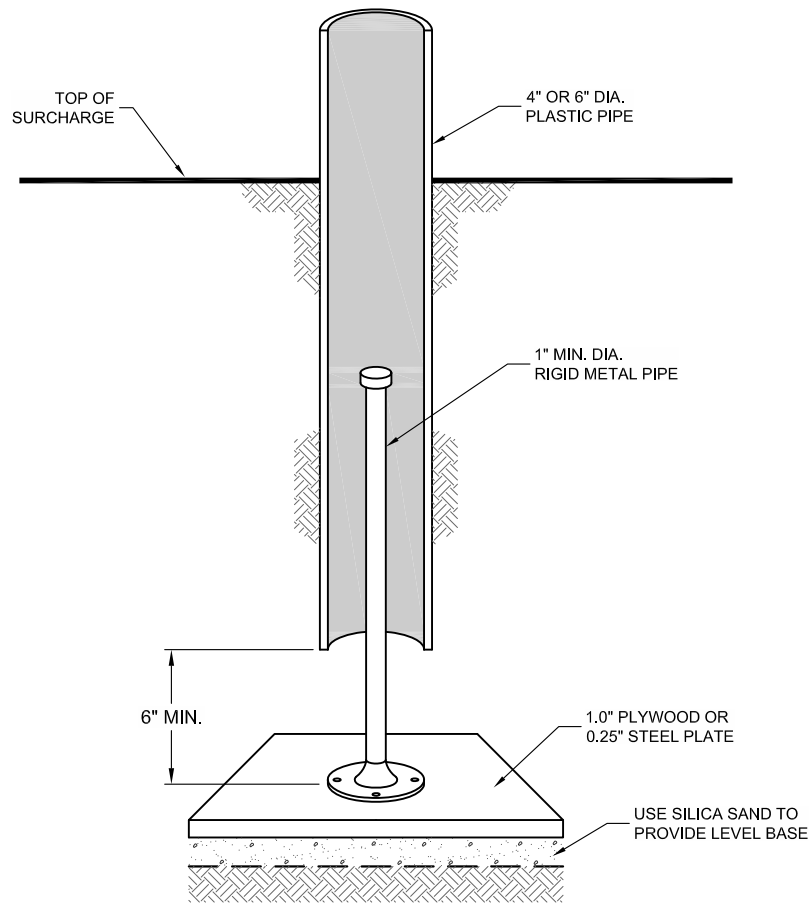

NOTES:

- 1.....LOCATION OF SETTLEMENT PLATES SHALL BE CLEARLY MARKED AND READILY VISIBLE (RED FLAG) TO EQUIPMENT OPERATORS.
- 2.....CONTRACTOR SHALL MAINTAIN 10-FOOT HORIZONTAL CLEARANCE FOR HEAVY EQUIPMENT WITHIN 5 FEET (VERTICAL) OF PLATE BASE. FILL WITHIN CLEARANCE AREA SHALL BE HAND COMPACTED TO PROJECT SPECIFICATIONS OR COMPACTED BY ALTERNATIVE APPROVED SOILS ENGINEER.
- 3.....AFTER 5 FEET (VERTICAL) OF FILL IS IN PLACE, THE CONTRACTOR SHALL MAINTAIN 5 FEET HORIZONTAL EQUIPMENT CLEARANCE. FILL IN CLEARANCE AREA SHALL BE HAND COMPACTED (OR APPROVED ALTERNATIVE) IN VERTICAL INCREMENTS NOT TO EXCEED 2 FEET.
- 4.....IN THE EVENT OF DAMAGE TO SETTLEMENT PLATE OR EXTENSION RESULTING FROM EQUIPMENT OPERATING WITHIN PRESCRIBED CLEARANCE AREA, CONTRACTORS SHALL IMMEDIATELY NOTIFY SOILS ENGINEER AND SHALL BE RESPONSIBLE FOR RESTORING THE SETTLEMENT PLATES TO WORKING ORDER.

NO SCALE

NO SCALE

SETTLEMENT MONUMENT DETAIL

GEOCON
INCORPORATED



GEOTECHNICAL ■ ENVIRONMENTAL ■ MATERIALS
6960 FLANDERS DRIVE - SAN DIEGO, CALIFORNIA 92121 - 2974
PHONE 858 558-6900 - FAX 858 558-6159

3ROOTS - VTM
SAN DIEGO, CALIFORNIA

RM / AML

DSK/GTYPD

DATE 07 - 02 - 2018

PROJECT NO. G2070 - 42 - 02

FIG. 9

ASSUMED CONDITIONS :

SLOPE HEIGHT	H = 100 feet
SLOPE INCLINATION	2 : 1 (Horizontal : Vertical)
TOTAL UNIT WEIGHT OF SOIL	$\gamma_t = 135$ pounds per cubic foot
ANGLE OF INTERNAL FRICTION	$\phi = 42$ degrees
APPARENT COHESION	C = 100 pounds per square foot
NO SEEPAGE FORCES	

ANALYSIS :

$\gamma_{c\phi} = \frac{\gamma_t H \tan \phi}{C}$	EQUATION (3-3), REFERENCE 1
FS = $\frac{NcfC}{\gamma_t H}$	EQUATION (3-2), REFERENCE 1
$\gamma_{c\phi} = 122$	CALCULATED USING EQ. (3-3)
Ncf = 250	DETERMINED USING FIGURE 10, REFERENCE 2
FS = 1.85	FACTOR OF SAFETY CALCULATED USING EQ. (3-2)

REFERENCES :

- 1.....Janbu, N., Stability Analysis of Slopes with Dimensionless Parameters, Harvard Soil Mechanics, Series No. 46, 1954
- 2.....Janbu, N., Discussion of J.M. Bell, Dimensionless Parameters for Homogeneous Earth Slopes, Journal of Soil Mechanics and Foundation Design, No. SM6, November 1967.

SLOPE STABILITY ANALYSIS - CUT SLOPES

GEOCON
INCORPORATED



GEOTECHNICAL ■ ENVIRONMENTAL ■ MATERIALS
6960 FLANDERS DRIVE - SAN DIEGO, CALIFORNIA 92121 - 2974
PHONE 858 558-6900 - FAX 858 558-6159

3ROOTS - VTM
SAN DIEGO, CALIFORNIA

RM / AML

DSK/GTYPD

DATE 07 - 02 - 2018

PROJECT NO. G2070 - 42 - 02

FIG. 10

ASSUMED CONDITIONS :

SLOPE HEIGHT	H = 60 feet
SLOPE INCLINATION	2 : 1 (Horizontal : Vertical)
TOTAL UNIT WEIGHT OF SOIL	$\gamma_t = 130$ pounds per cubic foot
ANGLE OF INTERNAL FRICTION	$\phi = 30$ degrees
APPARENT COHESION	C = 300 pounds per square foot
NO SEEPAGE FORCES	

ANALYSIS :

$\gamma_c \phi = \frac{\gamma_t H \tan \phi}{C}$	EQUATION (3-3), REFERENCE 1
FS = $\frac{NcfC}{\gamma_t H}$	EQUATION (3-2), REFERENCE 1
$\gamma_c \phi = 15$	CALCULATED USING EQ. (3-3)
Ncf = 43	DETERMINED USING FIGURE 10, REFERENCE 2
FS = 1.65	FACTOR OF SAFETY CALCULATED USING EQ. (3-2)

REFERENCES :

- 1.....Janbu, N., Stability Analysis of Slopes with Dimensionless Parameters, Harvard Soil Mechanics, Series No. 46, 1954
- 2.....Janbu, N., Discussion of J.M. Bell, Dimensionless Parameters for Homogeneous Earth Slopes, Journal of Soil Mechanics and Foundation Design, No. SM6, November 1967.

SLOPE STABILITY ANALYSIS - FILL SLOPES

GEOCON
INCORPORATED



GEOTECHNICAL ■ ENVIRONMENTAL ■ MATERIALS
6960 FLANDERS DRIVE - SAN DIEGO, CALIFORNIA 92121 - 2974
PHONE 858 558-6900 - FAX 858 558-6159

3ROOTS - VTM
SAN DIEGO, CALIFORNIA

RM / AML

DSK/GTYPD

DATE 07 - 02 - 2018

PROJECT NO. G2070 - 42 - 02

FIG. 11

ASSUMED CONDITIONS :

SLOPE HEIGHT	H = Infinite
DEPTH OF SATURATION	Z = 3 feet
SLOPE INCLINATION	2 : 1 (Horizontal : Vertical)
SLOPE ANGLE	i = 26.6 degrees
UNIT WEIGHT OF WATER	γ_w = 62.4 pounds per cubic foot
TOTAL UNIT WEIGHT OF SOIL	γ_t = 130 pounds per cubic foot
ANGLE OF INTERNAL FRICTION	ϕ = 30 degrees
APPARENT COHESION	C = 300 pounds per square foot

SLOPE SATURATED TO VERTICAL DEPTH Z BELOW SLOPE FACE

SEEPAGE FORCES PARALLEL TO SLOPE FACE

ANALYSIS :

$$FS = \frac{C + (\gamma_t - \gamma_w) Z \cos^2 i \tan \phi}{\gamma_t Z \sin i \cos i} = 2.5$$

REFERENCES :

- 1.....Haefeli, R. *The Stability of Slopes Acted Upon by Parallel Seepage*, Proc. Second International Conference, SMFE, Rotterdam, 1948, 1, 57-62
- 2.....Skempton, A. W., and F.A. Delory, *Stability of Natural Slopes in London Clay*, Proc. Fourth International Conference, SMFE, London, 1957, 2, 378-81

SURFICIAL SLOPE STABILITY ANALYSIS

GEOCON
INCORPORATED



GEOTECHNICAL ■ ENVIRONMENTAL ■ MATERIALS
6960 FLANDERS DRIVE - SAN DIEGO, CALIFORNIA 92121 - 2974
PHONE 858 558-6900 - FAX 858 558-6159

3ROOTS - VTM
SAN DIEGO, CALIFORNIA

RM / AML

DSK/GTYPD

DATE 07 - 02 - 2018

PROJECT NO. G2070 - 42 - 02

FIG. 12

APPENDIX

A

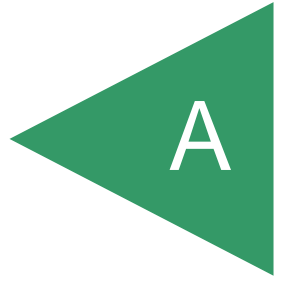

APPENDIX A
RECOMMENDED GRADING SPECIFICATIONS
FOR
3ROOTS
SAN DIEGO, CALIFORNIA
PROJECT NO. G2070-42-02

RECOMMENDED GRADING SPECIFICATIONS

1. GENERAL

- 1.1 These Recommended Grading Specifications shall be used in conjunction with the Geotechnical Report for the project prepared by Geocon. The recommendations contained in the text of the Geotechnical Report are a part of the earthwork and grading specifications and shall supersede the provisions contained hereinafter in the case of conflict.
- 1.2 Prior to the commencement of grading, a geotechnical consultant (Consultant) shall be employed for the purpose of observing earthwork procedures and testing the fills for substantial conformance with the recommendations of the Geotechnical Report and these specifications. The Consultant should provide adequate testing and observation services so that they may assess whether, in their opinion, the work was performed in substantial conformance with these specifications. It shall be the responsibility of the Contractor to assist the Consultant and keep them apprised of work schedules and changes so that personnel may be scheduled accordingly.
- 1.3 It shall be the sole responsibility of the Contractor to provide adequate equipment and methods to accomplish the work in accordance with applicable grading codes or agency ordinances, these specifications and the approved grading plans. If, in the opinion of the Consultant, unsatisfactory conditions such as questionable soil materials, poor moisture condition, inadequate compaction, and/or adverse weather result in a quality of work not in conformance with these specifications, the Consultant will be empowered to reject the work and recommend to the Owner that grading be stopped until the unacceptable conditions are corrected.

2. DEFINITIONS

- 2.1 **Owner** shall refer to the owner of the property or the entity on whose behalf the grading work is being performed and who has contracted with the Contractor to have grading performed.
- 2.2 **Contractor** shall refer to the Contractor performing the site grading work.
- 2.3 **Civil Engineer** or **Engineer of Work** shall refer to the California licensed Civil Engineer or consulting firm responsible for preparation of the grading plans, surveying and verifying as-graded topography.
- 2.4 **Consultant** shall refer to the soil engineering and engineering geology consulting firm retained to provide geotechnical services for the project.

- 2.5 **Soil Engineer** shall refer to a California licensed Civil Engineer retained by the Owner, who is experienced in the practice of geotechnical engineering. The Soil Engineer shall be responsible for having qualified representatives on-site to observe and test the Contractor's work for conformance with these specifications.
- 2.6 **Engineering Geologist** shall refer to a California licensed Engineering Geologist retained by the Owner to provide geologic observations and recommendations during the site grading.
- 2.7 **Geotechnical Report** shall refer to a soil report (including all addenda) which may include a geologic reconnaissance or geologic investigation that was prepared specifically for the development of the project for which these Recommended Grading Specifications are intended to apply.

3. MATERIALS

- 3.1 Materials for compacted fill shall consist of any soil excavated from the cut areas or imported to the site that, in the opinion of the Consultant, is suitable for use in construction of fills. In general, fill materials can be classified as *soil* fills, *soil-rock* fills or *rock* fills, as defined below.
- 3.1.1 **Soil fills** are defined as fills containing no rocks or hard lumps greater than 12 inches in maximum dimension and containing at least 40 percent by weight of material smaller than $\frac{3}{4}$ inch in size.
- 3.1.2 **Soil-rock fills** are defined as fills containing no rocks or hard lumps larger than 4 feet in maximum dimension and containing a sufficient matrix of soil fill to allow for proper compaction of soil fill around the rock fragments or hard lumps as specified in Paragraph 6.2. **Oversize rock** is defined as material greater than 12 inches.
- 3.1.3 **Rock fills** are defined as fills containing no rocks or hard lumps larger than 3 feet in maximum dimension and containing little or no fines. Fines are defined as material smaller than $\frac{3}{4}$ inch in maximum dimension. The quantity of fines shall be less than approximately 20 percent of the rock fill quantity.
- 3.2 Material of a perishable, spongy, or otherwise unsuitable nature as determined by the Consultant shall not be used in fills.
- 3.3 Materials used for fill, either imported or on-site, shall not contain hazardous materials as defined by the California Code of Regulations, Title 22, Division 4, Chapter 30, Articles 9

and 10; 40CFR; and any other applicable local, state or federal laws. The Consultant shall not be responsible for the identification or analysis of the potential presence of hazardous materials. However, if observations, odors or soil discoloration cause Consultant to suspect the presence of hazardous materials, the Consultant may request from the Owner the termination of grading operations within the affected area. Prior to resuming grading operations, the Owner shall provide a written report to the Consultant indicating that the suspected materials are not hazardous as defined by applicable laws and regulations.

- 3.4 The outer 15 feet of *soil-rock* fill slopes, measured horizontally, should be composed of properly compacted *soil* fill materials approved by the Consultant. *Rock* fill may extend to the slope face, provided that the slope is not steeper than 2:1 (horizontal:vertical) and a soil layer no thicker than 12 inches is track-walked onto the face for landscaping purposes. This procedure may be utilized provided it is acceptable to the governing agency, Owner and Consultant.
- 3.5 Samples of soil materials to be used for fill should be tested in the laboratory by the Consultant to determine the maximum density, optimum moisture content, and, where appropriate, shear strength, expansion, and gradation characteristics of the soil.
- 3.6 During grading, soil or groundwater conditions other than those identified in the Geotechnical Report may be encountered by the Contractor. The Consultant shall be notified immediately to evaluate the significance of the unanticipated condition

4. CLEARING AND PREPARING AREAS TO BE FILLED

- 4.1 Areas to be excavated and filled shall be cleared and grubbed. Clearing shall consist of complete removal above the ground surface of trees, stumps, brush, vegetation, man-made structures, and similar debris. Grubbing shall consist of removal of stumps, roots, buried logs and other unsuitable material and shall be performed in areas to be graded. Roots and other projections exceeding 1½ inches in diameter shall be removed to a depth of 3 feet below the surface of the ground. Borrow areas shall be grubbed to the extent necessary to provide suitable fill materials.
- 4.2 Asphalt pavement material removed during clearing operations should be properly disposed at an approved off-site facility or in an acceptable area of the project evaluated by Geocon and the property owner. Concrete fragments that are free of reinforcing steel may be placed in fills, provided they are placed in accordance with Section 6.2 or 6.3 of this document.

- 4.3 After clearing and grubbing of organic matter and other unsuitable material, loose or porous soils shall be removed to the depth recommended in the Geotechnical Report. The depth of removal and compaction should be observed and approved by a representative of the Consultant. The exposed surface shall then be plowed or scarified to a minimum depth of 6 inches and until the surface is free from uneven features that would tend to prevent uniform compaction by the equipment to be used.
- 4.4 Where the slope ratio of the original ground is steeper than 5:1 (horizontal:vertical), or where recommended by the Consultant, the original ground should be benched in accordance with the following illustration.

TYPICAL BENCHING DETAIL

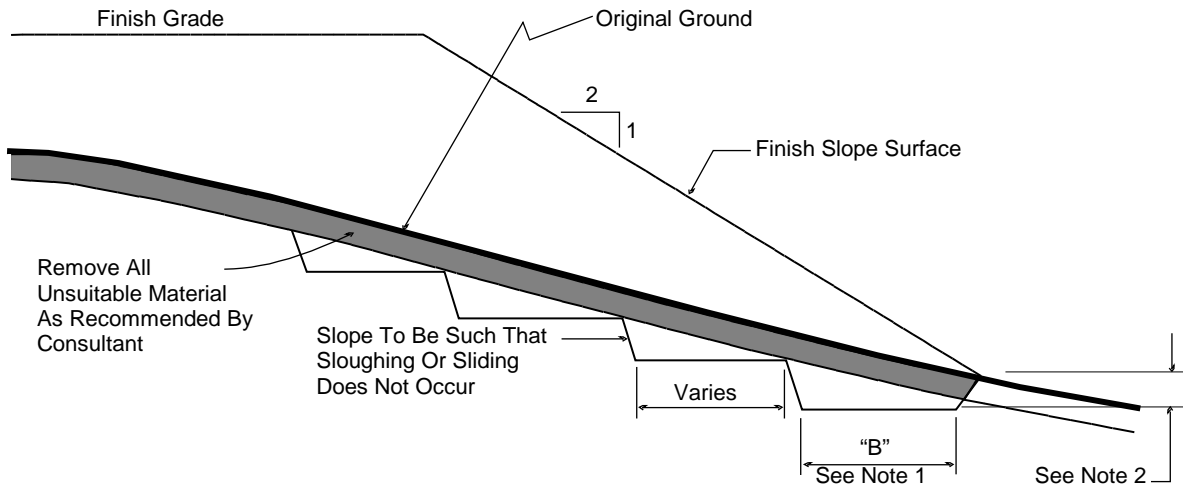

No Scale

- DETAIL NOTES: (1) Key width "B" should be a minimum of 10 feet, or sufficiently wide to permit complete coverage with the compaction equipment used. The base of the key should be graded horizontal, or inclined slightly into the natural slope.
- (2) The outside of the key should be below the topsoil or unsuitable surficial material and at least 2 feet into dense formational material. Where hard rock is exposed in the bottom of the key, the depth and configuration of the key may be modified as approved by the Consultant.

- 4.5 After areas to receive fill have been cleared and scarified, the surface should be moisture conditioned to achieve the proper moisture content, and compacted as recommended in Section 6 of these specifications.

5. COMPACTION EQUIPMENT

- 5.1 Compaction of *soil* or *soil-rock* fill shall be accomplished by sheepsfoot or segmented-steel wheeled rollers, vibratory rollers, multiple-wheel pneumatic-tired rollers, or other types of acceptable compaction equipment. Equipment shall be of such a design that it will be capable of compacting the *soil* or *soil-rock* fill to the specified relative compaction at the specified moisture content.
- 5.2 Compaction of *rock* fills shall be performed in accordance with Section 6.3.

6. PLACING, SPREADING AND COMPACTION OF FILL MATERIAL

- 6.1 *Soil* fill, as defined in Paragraph 3.1.1, shall be placed by the Contractor in accordance with the following recommendations:
- 6.1.1 *Soil* fill shall be placed by the Contractor in layers that, when compacted, should generally not exceed 8 inches. Each layer shall be spread evenly and shall be thoroughly mixed during spreading to obtain uniformity of material and moisture in each layer. The entire fill shall be constructed as a unit in nearly level lifts. Rock materials greater than 12 inches in maximum dimension shall be placed in accordance with Section 6.2 or 6.3 of these specifications.
- 6.1.2 In general, the *soil* fill shall be compacted at a moisture content at or above the optimum moisture content as determined by ASTM D 1557.
- 6.1.3 When the moisture content of *soil* fill is below that specified by the Consultant, water shall be added by the Contractor until the moisture content is in the range specified.
- 6.1.4 When the moisture content of the *soil* fill is above the range specified by the Consultant or too wet to achieve proper compaction, the *soil* fill shall be aerated by the Contractor by blading/mixing, or other satisfactory methods until the moisture content is within the range specified.
- 6.1.5 After each layer has been placed, mixed, and spread evenly, it shall be thoroughly compacted by the Contractor to a relative compaction of at least 90 percent. Relative compaction is defined as the ratio (expressed in percent) of the in-place dry density of the compacted fill to the maximum laboratory dry density as determined in accordance with ASTM D 1557. Compaction shall be continuous over the entire area, and compaction equipment shall make sufficient passes so that the specified minimum relative compaction has been achieved throughout the entire fill.

- 6.1.6 Where practical, soils having an Expansion Index greater than 50 should be placed at least 3 feet below finish pad grade and should be compacted at a moisture content generally 2 to 4 percent greater than the optimum moisture content for the material.
 - 6.1.7 Properly compacted *soil* fill shall extend to the design surface of fill slopes. To achieve proper compaction, it is recommended that fill slopes be over-built by at least 3 feet and then cut to the design grade. This procedure is considered preferable to track-walking of slopes, as described in the following paragraph.
 - 6.1.8 As an alternative to over-building of slopes, slope faces may be back-rolled with a heavy-duty loaded sheepsfoot or vibratory roller at maximum 4-foot fill height intervals. Upon completion, slopes should then be track-walked with a D-8 dozer or similar equipment, such that a dozer track covers all slope surfaces at least twice.
- 6.2 *Soil-rock* fill, as defined in Paragraph 3.1.2, shall be placed by the Contractor in accordance with the following recommendations:
- 6.2.1 Rocks larger than 12 inches but less than 4 feet in maximum dimension may be incorporated into the compacted *soil* fill, but shall be limited to the area measured 15 feet minimum horizontally from the slope face and 5 feet below finish grade or 3 feet below the deepest utility, whichever is deeper.
 - 6.2.2 Rocks or rock fragments up to 4 feet in maximum dimension may either be individually placed or placed in windrows. Under certain conditions, rocks or rock fragments up to 10 feet in maximum dimension may be placed using similar methods. The acceptability of placing rock materials greater than 4 feet in maximum dimension shall be evaluated during grading as specific cases arise and shall be approved by the Consultant prior to placement.
 - 6.2.3 For individual placement, sufficient space shall be provided between rocks to allow for passage of compaction equipment.
 - 6.2.4 For windrow placement, the rocks should be placed in trenches excavated in properly compacted *soil* fill. Trenches should be approximately 5 feet wide and 4 feet deep in maximum dimension. The voids around and beneath rocks should be filled with approved granular soil having a Sand Equivalent of 30 or greater and should be compacted by flooding. Windrows may also be placed utilizing an "open-face" method in lieu of the trench procedure, however, this method should first be approved by the Consultant.

- 6.2.5 Windrows should generally be parallel to each other and may be placed either parallel to or perpendicular to the face of the slope depending on the site geometry. The minimum horizontal spacing for windrows shall be 12 feet center-to-center with a 5-foot stagger or offset from lower courses to next overlying course. The minimum vertical spacing between windrow courses shall be 2 feet from the top of a lower windrow to the bottom of the next higher windrow.
- 6.2.6 Rock placement, fill placement and flooding of approved granular soil in the windrows should be continuously observed by the Consultant.
- 6.3 *Rock* fills, as defined in Section 3.1.3, shall be placed by the Contractor in accordance with the following recommendations:
- 6.3.1 The base of the *rock* fill shall be placed on a sloping surface (minimum slope of 2 percent). The surface shall slope toward suitable subdrainage outlet facilities. The *rock* fills shall be provided with subdrains during construction so that a hydrostatic pressure buildup does not develop. The subdrains shall be permanently connected to controlled drainage facilities to control post-construction infiltration of water.
- 6.3.2 *Rock* fills shall be placed in lifts not exceeding 3 feet. Placement shall be by rock trucks traversing previously placed lifts and dumping at the edge of the currently placed lift. Spreading of the *rock* fill shall be by dozer to facilitate *seating* of the rock. The *rock* fill shall be watered heavily during placement. Watering shall consist of water trucks traversing in front of the current rock lift face and spraying water continuously during rock placement. Compaction equipment with compactive energy comparable to or greater than that of a 20-ton steel vibratory roller or other compaction equipment providing suitable energy to achieve the required compaction or deflection as recommended in Paragraph 6.3.3 shall be utilized. The number of passes to be made should be determined as described in Paragraph 6.3.3. Once a *rock* fill lift has been covered with *soil* fill, no additional *rock* fill lifts will be permitted over the *soil* fill.
- 6.3.3 Plate bearing tests, in accordance with ASTM D 1196, may be performed in both the compacted *soil* fill and in the *rock* fill to aid in determining the required minimum number of passes of the compaction equipment. If performed, a minimum of three plate bearing tests should be performed in the properly compacted *soil* fill (minimum relative compaction of 90 percent). Plate bearing tests shall then be performed on areas of *rock* fill having two passes, four passes and six passes of the compaction equipment, respectively. The number of passes required for the *rock* fill shall be determined by comparing the results of the plate bearing tests for the *soil* fill and the *rock* fill and by evaluating the deflection

variation with number of passes. The required number of passes of the compaction equipment will be performed as necessary until the plate bearing deflections are equal to or less than that determined for the properly compacted *soil* fill. In no case will the required number of passes be less than two.

- 6.3.4 A representative of the Consultant should be present during *rock* fill operations to observe that the minimum number of “passes” have been obtained, that water is being properly applied and that specified procedures are being followed. The actual number of plate bearing tests will be determined by the Consultant during grading.
- 6.3.5 Test pits shall be excavated by the Contractor so that the Consultant can state that, in their opinion, sufficient water is present and that voids between large rocks are properly filled with smaller rock material. In-place density testing will not be required in the *rock* fills.
- 6.3.6 To reduce the potential for “piping” of fines into the *rock* fill from overlying *soil* fill material, a 2-foot layer of graded filter material shall be placed above the uppermost lift of *rock* fill. The need to place graded filter material below the *rock* should be determined by the Consultant prior to commencing grading. The gradation of the graded filter material will be determined at the time the *rock* fill is being excavated. Materials typical of the *rock* fill should be submitted to the Consultant in a timely manner, to allow design of the graded filter prior to the commencement of *rock* fill placement.
- 6.3.7 *Rock* fill placement should be continuously observed during placement by the Consultant.

7. SUBDRAINS

- 7.1 The geologic units on the site may have permeability characteristics and/or fracture systems that could be susceptible under certain conditions to seepage. The use of canyon subdrains may be necessary to mitigate the potential for adverse impacts associated with seepage conditions. Canyon subdrains with lengths in excess of 500 feet or extensions of existing offsite subdrains should use 8-inch-diameter pipes. Canyon subdrains less than 500 feet in length should use 6-inch-diameter pipes.

TYPICAL CANYON DRAIN DETAIL

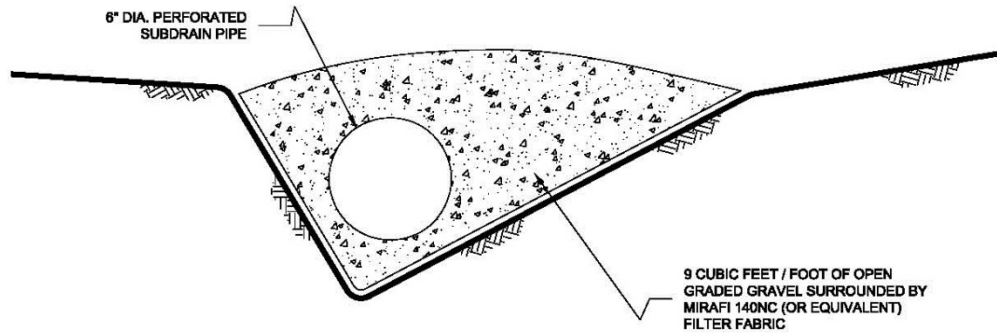
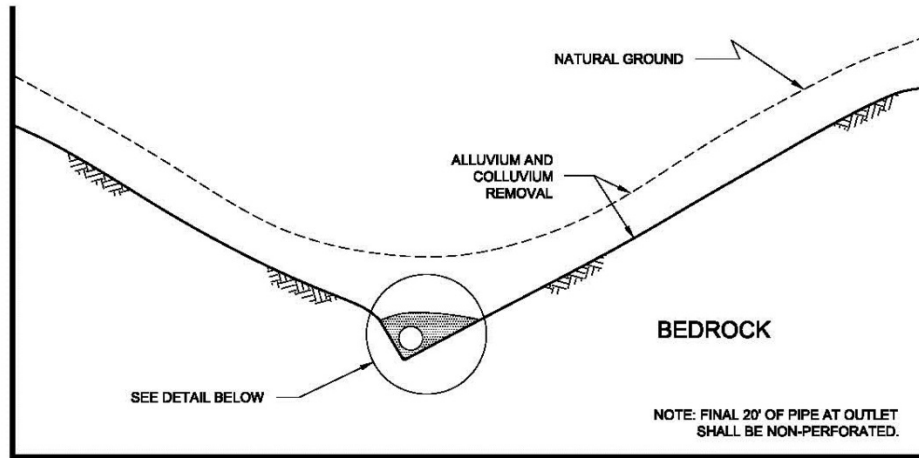

NOTES:

- 1.....8-INCH DIAMETER, SCHEDULE 80 PVC PERFORATED PIPE FOR FILLS IN EXCESS OF 100-FEET IN DEPTH OR A PIPE LENGTH OF LONGER THAN 500 FEET.
- 2.....6-INCH DIAMETER, SCHEDULE 40 PVC PERFORATED PIPE FOR FILLS LESS THAN 100-FEET IN DEPTH OR A PIPE LENGTH SHORTER THAN 500 FEET.

NO SCALE

7.2 Slope drains within stability fill keyways should use 4-inch-diameter (or larger) pipes.

TYPICAL STABILITY FILL DETAIL

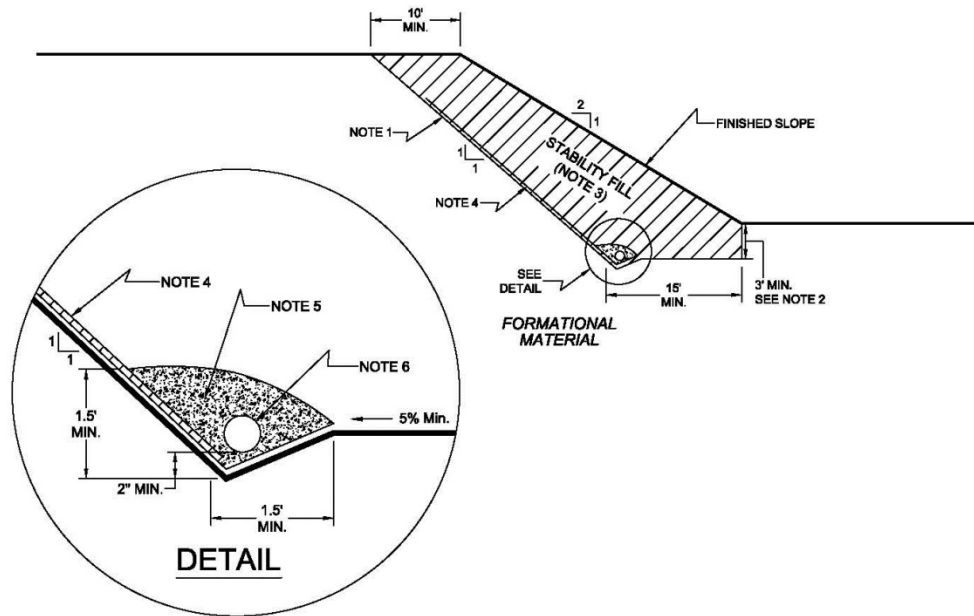

NOTES:

- 1.....EXCAVATE BACKCUT AT 1:1 INCLINATION (UNLESS OTHERWISE NOTED).
- 2.....BASE OF STABILITY FILL TO BE 3 FEET INTO FORMATIONAL MATERIAL, SLOPING A MINIMUM 5% INTO SLOPE.
- 3.....STABILITY FILL TO BE COMPOSED OF PROPERLY COMPACTED GRANULAR SOIL.
- 4.....CHIMNEY DRAINS TO BE APPROVED PREFABRICATED CHIMNEY DRAIN PANELS (MIRADRAIN G200N OR EQUIVALENT) SPACED APPROXIMATELY 20 FEET CENTER TO CENTER AND 4 FEET WIDE. CLOSER SPACING MAY BE REQUIRED IF SEEPAGE IS ENCOUNTERED.
- 5.....FILTER MATERIAL TO BE 3/4-INCH, OPEN-GRADED CRUSHED ROCK ENCLOSED IN APPROVED FILTER FABRIC (MIRAFI 140NC).
- 6.....COLLECTOR PIPE TO BE 4-INCH MINIMUM DIAMETER, PERFORATED, THICK-WALLED PVC SCHEDULE 40 OR EQUIVALENT, AND SLOPED TO DRAIN AT 1 PERCENT MINIMUM TO APPROVED OUTLET.

NO SCALE

7.3 The actual subdrain locations will be evaluated in the field during the remedial grading operations. Additional drains may be necessary depending on the conditions observed and the requirements of the local regulatory agencies. Appropriate subdrain outlets should be evaluated prior to finalizing 40-scale grading plans.

7.4 *Rock fill* or *soil-rock fill* areas may require subdrains along their down-slope perimeters to mitigate the potential for buildup of water from construction or landscape irrigation. The subdrains should be at least 6-inch-diameter pipes encapsulated in gravel and filter fabric. *Rock fill* drains should be constructed using the same requirements as canyon subdrains.

7.5 Prior to outletting, the final 20-foot segment of a subdrain that will not be extended during future development should consist of non-perforated drainpipe. At the non-perforated/perforated interface, a seepage cutoff wall should be constructed on the downslope side of the pipe.

TYPICAL CUT OFF WALL DETAIL

FRONT VIEW

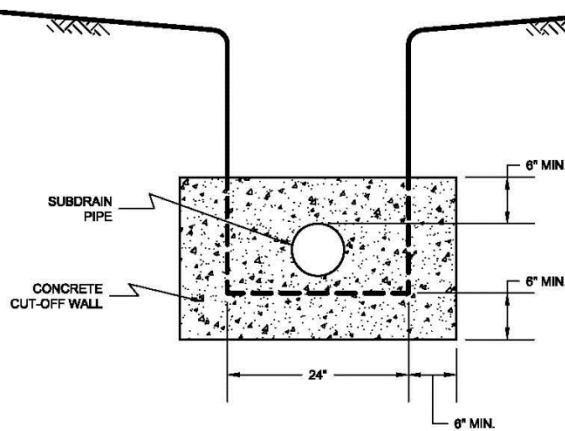

NO SCALE

SIDE VIEW

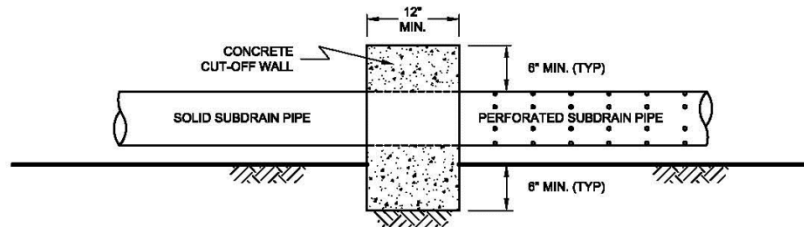

NO SCALE

7.6 Subdrains that discharge into a natural drainage course or open space area should be provided with a permanent headwall structure.

TYPICAL HEADWALL DETAIL

FRONT VIEW

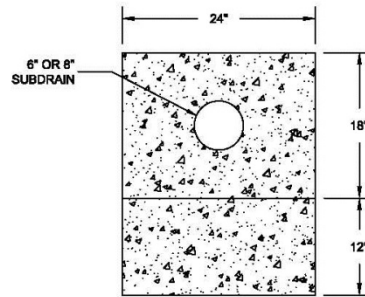

NO SCALE

SIDE VIEW

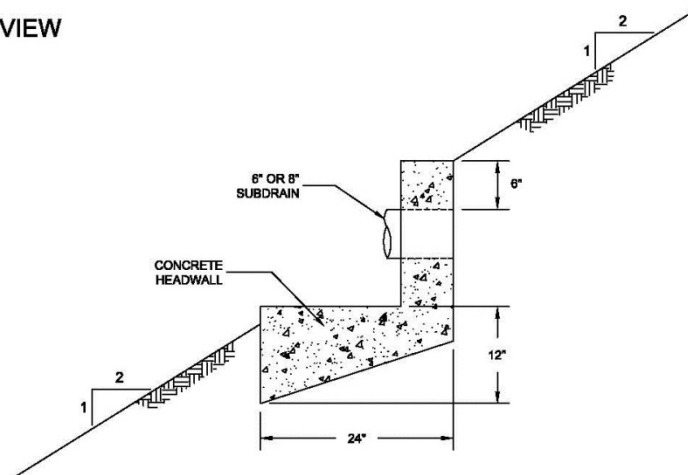

NOTE: HEADWALL SHOULD OUTLET AT TOE OF FILL SLOPE
OR INTO CONTROLLED SURFACE DRAINAGE

NO SCALE

- 7.7 The final grading plans should show the location of the proposed subdrains. After completion of remedial excavations and subdrain installation, the project civil engineer should survey the drain locations and prepare an “as-built” map showing the drain locations. The final outlet and connection locations should be determined during grading operations. Subdrains that will be extended on adjacent projects after grading can be placed on formational material and a vertical riser should be placed at the end of the subdrain. The grading contractor should consider videoing the subdrains shortly after burial to check proper installation and functionality. The contractor is responsible for the performance of the drains.

8. OBSERVATION AND TESTING

- 8.1 The Consultant shall be the Owner's representative to observe and perform tests during clearing, grubbing, filling, and compaction operations. In general, no more than 2 feet in vertical elevation of *soil* or *soil-rock* fill should be placed without at least one field density test being performed within that interval. In addition, a minimum of one field density test should be performed for every 2,000 cubic yards of *soil* or *soil-rock* fill placed and compacted.
- 8.2 The Consultant should perform a sufficient distribution of field density tests of the compacted *soil* or *soil-rock* fill to provide a basis for expressing an opinion whether the fill material is compacted as specified. Density tests shall be performed in the compacted materials below any disturbed surface. When these tests indicate that the density of any layer of fill or portion thereof is below that specified, the particular layer or areas represented by the test shall be reworked until the specified density has been achieved.
- 8.3 During placement of *rock* fill, the Consultant should observe that the minimum number of passes have been obtained per the criteria discussed in Section 6.3.3. The Consultant should request the excavation of observation pits and may perform plate bearing tests on the placed *rock* fills. The observation pits will be excavated to provide a basis for expressing an opinion as to whether the *rock* fill is properly seated and sufficient moisture has been applied to the material. When observations indicate that a layer of *rock* fill or any portion thereof is below that specified, the affected layer or area shall be reworked until the *rock* fill has been adequately seated and sufficient moisture applied.
- 8.4 A settlement monitoring program designed by the Consultant may be conducted in areas of *rock* fill placement. The specific design of the monitoring program shall be as recommended in the Conclusions and Recommendations section of the project Geotechnical Report or in the final report of testing and observation services performed during grading.
- 8.5 We should observe the placement of subdrains, to check that the drainage devices have been placed and constructed in substantial conformance with project specifications.
- 8.6 Testing procedures shall conform to the following Standards as appropriate:

8.6.1 Soil and Soil-Rock Fills:

- 8.6.1.1 Field Density Test, ASTM D 1556, *Density of Soil In-Place By the Sand-Cone Method.*

- 8.6.1.2 Field Density Test, Nuclear Method, ASTM D 6938, *Density of Soil and Soil-Aggregate In-Place by Nuclear Methods (Shallow Depth)*.
- 8.6.1.3 Laboratory Compaction Test, ASTM D 1557, *Moisture-Density Relations of Soils and Soil-Aggregate Mixtures Using 10-Pound Hammer and 18-Inch Drop*.
- 8.6.1.4 Expansion Index Test, ASTM D 4829, *Expansion Index Test*.

9. PROTECTION OF WORK

- 9.1 During construction, the Contractor shall properly grade all excavated surfaces to provide positive drainage and prevent ponding of water. Drainage of surface water shall be controlled to avoid damage to adjoining properties or to finished work on the site. The Contractor shall take remedial measures to prevent erosion of freshly graded areas until such time as permanent drainage and erosion control features have been installed. Areas subjected to erosion or sedimentation shall be properly prepared in accordance with the Specifications prior to placing additional fill or structures.
- 9.2 After completion of grading as observed and tested by the Consultant, no further excavation or filling shall be conducted except in conjunction with the services of the Consultant.

10. CERTIFICATIONS AND FINAL REPORTS

- 10.1 Upon completion of the work, Contractor shall furnish Owner a certification by the Civil Engineer stating that the lots and/or building pads are graded to within 0.1 foot vertically of elevations shown on the grading plan and that all tops and toes of slopes are within 0.5 foot horizontally of the positions shown on the grading plans. After installation of a section of subdrain, the project Civil Engineer should survey its location and prepare an *as-built* plan of the subdrain location. The project Civil Engineer should verify the proper outlet for the subdrains and the Contractor should ensure that the drain system is free of obstructions.
- 10.2 The Owner is responsible for furnishing a final as-graded soil and geologic report satisfactory to the appropriate governing or accepting agencies. The as-graded report should be prepared and signed by a California licensed Civil Engineer experienced in geotechnical engineering and by a California Certified Engineering Geologist, indicating that the geotechnical aspects of the grading were performed in substantial conformance with the Specifications or approved changes to the Specifications.

LIST OF REFERENCES

1. Boore, D. M., and G. M Atkinson (2006), Boore-Atkinson *NGA Ground Motion Relations for the Geometric Mean Horizontal Component of Peak and Spectral Ground Motion Parameters*, Report Number PEER 2007/01, May 2007.
2. Chiou, Brian S. J., and Robert R. Youngs, *A NGA Model for the Average Horizontal Component of Peak Ground Motion and Response Spectra*, preprint for article to be published in NGA Special Edition for Earthquake Spectra, Spring 2008.
3. California Department of Conservation, Division of Mines and Geology, *Probabilistic Seismic Hazard Assessment for the State of California*, Open File Report 96-08, 1996.
4. California Geological Survey, *Seismic Shaking Hazards in California*, Based on the USGS/CGS Probabilistic Seismic Hazards Assessment (PSHA) Model, 2002 (revised April 2003). 0% probability of being exceeded in 50 years.
<http://redirect.conservation.ca.gov/cgs/rghm/pshamap/pshamain.html>
5. Campbell, K. W., Y. Bozorgnia, *NGA Ground Motion Model for the Geometric Mean Horizontal Component of PGA, PGV, PGD and 5% Damped Linear Elastic Response Spectra for Periods Ranging from 0.01 to 10 s*, Preprint of version submitted for publication in the NGA Special Volume of Earthquake Spectra, Volume 24, Issue 1, pages 139-171, February 2008.
6. *Characterization of San Diego's Stadium Conglomerate For Tunnel Design*, 2001 Proceedings Rapid Excavation and Tunneling Conference, pgs. 33-45.
7. Geocon Incorporated, *Compaction Test Summary Report, Hanson Carroll Canyon Materials Plant, San Diego, California*, dated April 14, 2017 (Project No. G2070-42-01).
8. Geocon Incorporated, *Update Geotechnical Investigation for Vesting Tentative Map, 3Roots, San Diego, California*, dated November 10, 2017 (Project No. G2070-42-02).
9. Geocon Incorporated, *Infiltration Feasibility Condition Letter, 3 Roots, San Diego, California*, dated March 26, 2018 (Project No. G2070-42-02).
10. Geocon Incorporated, *Report of In-Place Density Test Results for Compaction Testing Performed From February 17, 2017 through August 7, 2017, Hanson Aggregates Pacific Southwest Region, Carroll Canyon Materials Plant – South Pit, San Diego, California*, dated June 4, 2018 (Project No. 01145-42-09E).
11. Jennings, C. W., 1994, California Division of Mines and Geology, *Fault Activity Map of California and Adjacent Areas*, California Geologic Data Map Series Map No. 6.
12. Kennedy, M. P., and S. S. Tan, 2005, *Geologic Map of the San Diego 30'x60' Quadrangle, California*, USGS Regional Map Series Map No. 3, Scale 1:100,000.
13. Risk Engineering, *EZ-FRISK*, Version 7.65.
14. Unpublished reports and maps on file with Geocon Incorporated.
15. USGS computer program, *Seismic Hazard Curves and Uniform Hazard Response Spectra*.

**UPDATE LETTER AND RESPONSE TO
GEOTECHNICAL REVIEW COMMENTS**

**3ROOTS
P.T.S. NO. 587128
SAN DIEGO, CALIFORNIA**



GEOCON
INCORPORATED

GEOTECHNICAL
ENVIRONMENTAL
MATERIALS

PREPARED FOR

**MESA COMMUNITY PARTNERS, LLC, AND
CALATLANTIC GROUP, INC.,
A DELAWARE CORPORATION
SAN DIEGO, CALIFORNIA**

**AUGUST 8, 2018
PROJECT NO. G2070-42-02**



Project No. G2070-42-02
August 8, 2018

Mesa Community Partners, LLC, and
CalAtlantic Group, Inc., A Delaware Corporation
16465 Via Esprillo, Suite 150
San Diego, California 92127

Attention: Mr. Ryan Green

Subject: UPDATE LETTER AND RESPONSE TO GEOTECHNICAL REVIEW COMMENTS
3ROOTS
P.T.S. NO. 587128
SAN DIEGO, CALIFORNIA

Reference: *Update Geotechnical Report for Vesting Tentative Map, 3Roots, San Diego, California,*
prepared by Geocon Incorporated, dated July 2, 2018 (Project No. G2070-42-02).

Dear Mr. Green:

This correspondence has been prepared to respond to the geotechnical comments (Issues 28 through 31) contained in the July 30, 2018, *Cycle 27 Issues*, pages 34 and 35 prepared by Mr. Jim Quinn from the City of San Diego, LDR-Geology department. Each issue along with our response is presented below.

Issue 28: *Provide a geotechnical map that shows the locations of the compaction tests reported June 4, 2018.*

Response: See attached *Density Test Location Map*, Figure 1 for location of compaction tests (Test Nos. 5226 through 5284).

Issue 29: *The referenced report dated July 2, 2018 (page 3) indicates “undocumented fill will remain after reclamation grading within the park site and adjacent non-structural areas located in the southern portion of the site.” The California Code of Regulations Section 3502(b)(4) indicates “where ultimate site uses include roads, building sites, or other improvements sensitive to settlement, the reclamation plans shall include compaction of fill materials in conformance with good engineering practice.”*

Response: With respect to park site improvements, the locations of buildings and/or settlement sensitive improvements is not yet known. Once the location of these improvements is known, update reports will be prepared that provide remedial grading and foundation recommendations to account for the undocumented fill. In areas outside of the park and adjacent non-structural areas, including roads, building sites and other improvements sensitive to settlement, undocumented fill will be removed and replaced as structural fill during reclamation grading activities.

Issue 30: *The project's geotechnical consultant could note that the California Building Code Appendix J, Section 107.5 has been adopted per San Diego Municipal Code 145.3601(e), which states "all fill materials shall be compacted to 90 percent of the maximum density as determined by ASTM D 1557, Modified Proctor, in lifts not exceeding 12 inches in depth." Special fill compaction requirements may apply if fill soil is placed within FEMA Special Flood Hazard Areas.*

Response: It is our understanding that a Conditional Letter of Map Revision (CLOMR) will be submitted to FEMA that will request modification to the current flood plain boundaries into the proposed channel banks shown on the VTM. No additional fill placement is expected within the revised FEMA Special Flood Hazard Areas.

Recommendations have been provided in the referenced report to place all fill during grading at a relative compaction of at least 90 percent of the maximum dry density as determined by ASTM D 1557 in layers no thicker than will allow for adequate bonding and compaction. This recommendation complies with CBC Appendix J Section 107.5.

Issue 31: *The project's geotechnical consultant indicates that they do not anticipate adverse settlement. The consultant should clarify if the anticipated fill settlement will adversely impact the proposed development including proposed public improvements.*

Response: Preliminary estimates of expected settlement are provided in our referenced report. As indicated in Section 7.7.1 of the geotechnical report, we do not expect settlement will impact proposed utilities with gradients of 1 percent or greater. As indicated in Sections 7.7.1 and Section 7.9.3, foundations will need to be designed to accommodate settlement. We do not anticipate that fill settlement will adversely impact the proposed development including proposed public improvements if the recommendations of our report are followed.

If there are any questions regarding this correspondence, or if we may be of further service, please contact the undersigned at your convenience.

Very truly yours,

GEOCON INCORPORATED



Rodney C. Mikesell
GE 2533

Troy K. Reist
CEG 2408

RCM:TKR:dmc

(e-mail) Addressee
(e-mail) Ms. Allegra Parisi
(3) Project Design Consultants
Attention: Ms. Marina Wurst

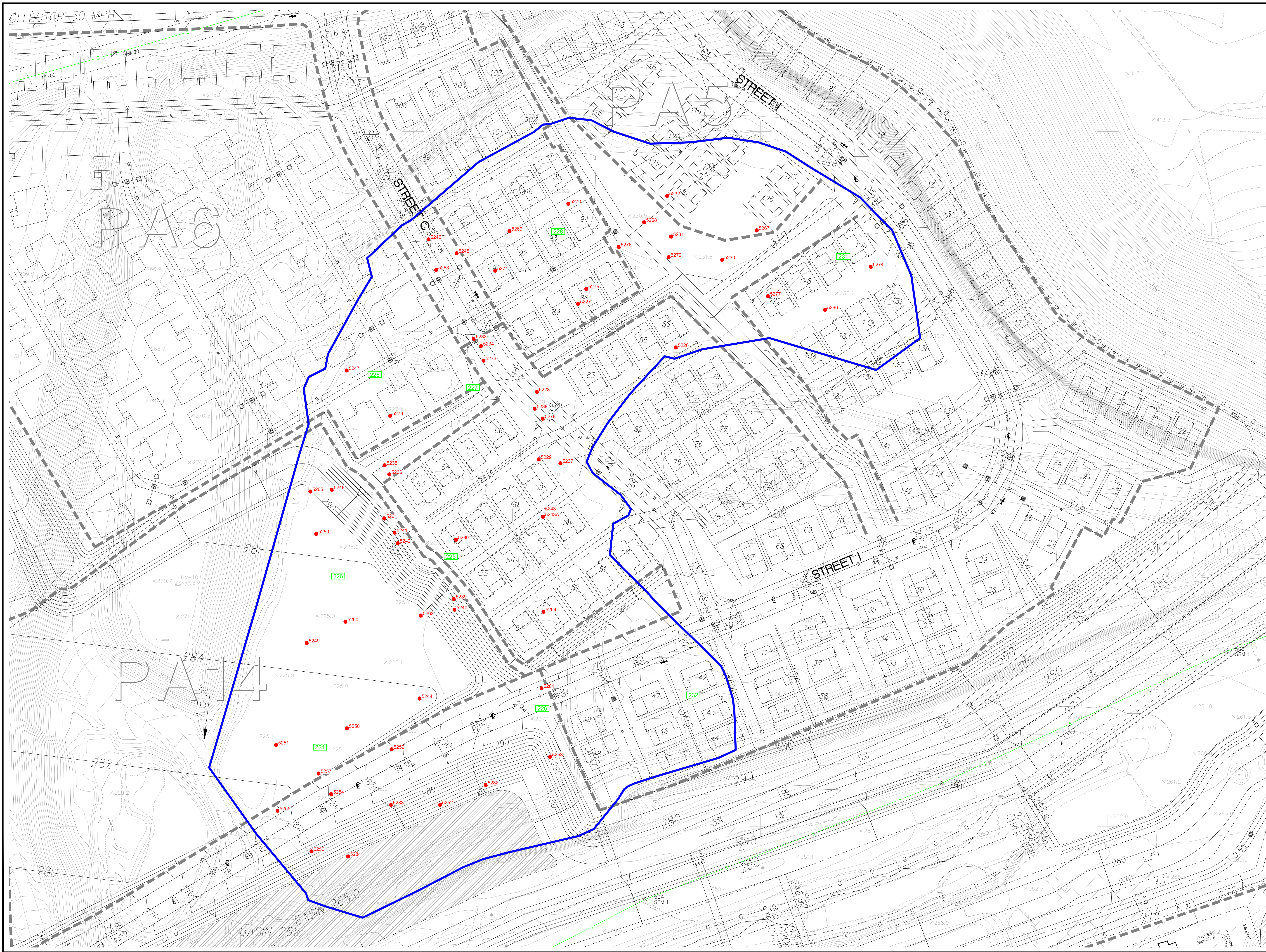



KEY MAP
NOT TO SCALE

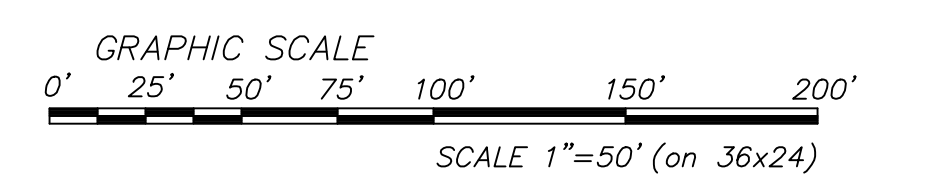
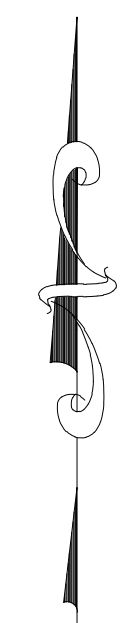

GEOCON LEGEND

- 5226-5284 APPROX. LOCATION OF DENSITY TEST
- 2228 APPROX. ELEVATION OF CONTACT WITH STADIUM CONGLOMERATE
- APPROX. AREA OF COMPACTED FILL

DENSITY TEST LOCATION MAP
3ROOTS
SAN DIEGO, CALIFORNIA

GEOCON INCORPORATED GEOTECHNICAL ■ ENVIRONMENTAL ■ MATERIALS 6960 FLANDERS DRIVE ■ SAN DIEGO, CALIFORNIA 92121-2774 PHONE 619 558-6900 ■ FAX 619 558-6159	SCALE 1" = 50'	DATE 08 - 08 - 2018
	PROJECT NO. G2070 - 42 - 02	FIGURE 1
	SHEET 1 OF 1	

Printed 08/03/2018 11:59AM | By ALVIN LADRILLONDO | File Location: \\PROJECTS\G2070-42-02\Grading\Sheet\G2070-42-02 Density Map.dwg



Project No. G2070-42-02
November 9, 2018

Mesa Community Partners, LLC, and
CalAtlantic Group, Inc., A Delaware Corporation
16465 Via Esprillo, Suite 150
San Diego, California 92127

Attention: Mr. Ryan Green

Subject: ADDENDUM TO GEOTECHNICAL REPORT AND RESPONSE TO
GEOTECHNICAL REVIEW COMMENTS
3ROOTS
P.T.S. NO. 587128
SAN DIEGO, CALIFORNIA

- Reference:
1. *Update Geotechnical Report for Vesting Tentative Map, 3Roots, San Diego, California*, prepared by Geocon Incorporated, dated July 2, 2018 (Project No. G2070-42-02).
 2. *Update Geotechnical Investigation for Vesting Tentative Map, 3Roots, San Diego, California*, prepared by Geocon Incorporated, dated November 10, 2017 (Project No. G2070-42-02).
 3. *City of San Diego Review Comments, 3-Roots, Project No. 587128*, LDR-Geology, dated November 6, 2018.

Dear Mr. Green:

This correspondence has been prepared to respond to the comments contained in Reference 3 prepared by Mr. Jim Quinn from the City of San Diego, LDR-Geology department. Each issue along with our response is presented below.

Issue 29: *The referenced report dated July 2, 2018 (page 3) indicates “undocumented fill will remain after reclamation grading within the park site and adjacent non-structural areas located in the southern portion of the site.” The California Code of Regulations Section 3502(b)(4) indicates “where ultimate site uses include roads, building sites, or other improvements sensitive to settlement, the reclamation plans shall include compaction of fill materials in conformance with good engineering practice.”*

Response: Remedial grading will be performed to remove undocumented fill and replace it with compacted fill across the project site, including the park site and adjacent non-structural areas located in the southern portion of the site.

Issue 30: *The project’s geotechnical consultant could note that the California Building Code Appendix J, Section 107.5 has been adopted per San Diego Municipal Code 145.3601(e), which states “all fill materials shall be compacted to 90 percent of the maximum density*

as determined by ASTM D1557, Modified Proctor, in lifts not exceeding 12 inches in depth." Special fill compaction requirements may apply if fill soil is placed within FEMA Special Flood Hazard Areas.

Response: Acknowledged. Recommendations provided in References 1 and 2 are to compact all fill to a relative compaction of at least 90 percent of the maximum density as determined by ASTM D1557.

All fill placed with in a FEMA Special Flood Hazard Area will also be compacted to 90 percent of the maximum density as determined by ASTM D1557.

If there are any questions regarding this correspondence, or if we may be of further service, please contact the undersigned at your convenience.

Very truly yours,

GEOCON INCORPORATED

Rodney C. Mikesell
GE 2533

RCM:dmc

(e-mail) Addressee



**ADDENDUM TO
GEOTECHNICAL INVESTIGATION
FOR VESTING TENTATIVE MAP**

**3ROOTS
SAN DIEGO, CALIFORNIA**



GEOCON
INCORPORATED

GEOTECHNICAL
ENVIRONMENTAL
MATERIALS

PREPARED FOR

**MESA COMMUNITY PARTNERS, LLC, AND
CALATLANTIC GROUP, INC.,
A DELAWARE CORPORATION
SAN DIEGO, CALIFORNIA**

**FEBRUARY 7, 2019
PROJECT NO. G2070-42-03**



Project No. G2070-42-03
February 7, 2019

Mesa Community Partners, LLC, and
CalAtlantic Group, Inc., A Delaware Corporation
16465 Via Esprillo, Suite 150
San Diego, California 92127

Attention: Mr. Ryan Green

Subject: ADDENDUM TO GEOTECHNICAL INVESTIGATION
FOR VESTING TENTATIVE MAP
3ROOTS
SAN DIEGO, CALIFORNIA

- References:
1. *Update Geotechnical Investigation for Vesting Tentative Map, 3Roots, San Diego, California*, prepared by Geocon Incorporated, dated November 10, 2017 (Project No. G2070-42-02).
 2. *Update Geotechnical Report for Vesting Tentative Map, 3Roots, San Diego, California*, prepared by Geocon Incorporated, dated July 2, 2018 (Project No. G2070-42-02).

Dear Mr. Green:

In accordance with your request, we have prepared this addendum report to summarize our additional subsurface investigation performed within the proposed 25-acre community park site area. The 25-acre community park site is part of the 3Roots development project, which is generally located to the east and northeast of the intersection of Camino Santa Fe and Carroll Canyon Road, in the Mira Mesa area of San Diego, California (see *Vicinity Map*, Figure 1). We have also updated our *Geologic Map* (see Figure 2) to include newly acquired subsurface data, which can be used to refine remedial grading quantities for the park site area. Additionally, edits have been made to previous Planning Area (PA) and lots across the site. Figure 2 includes the updated information to date. Based on the new information included herein, the conclusions and recommendations for the project presented in References 1 and 2 remain applicable.

PURPOSE AND SCOPE

We performed our additional subsurface investigation between January 22 and 25, 2019, which included drilling and logging 12 large-diameter borings using a truck-mounted-bucket-auger-drill rig.

Borings were advanced to a maximum depth of approximately 30 feet below existing site grades, logged from cuttings, and downhole logged where subsurface conditions permitted. Logs of our recent exploratory borings are presented in *Appendix A*. Borings were located within and adjacent to lease areas 5 and 12 (see Figure 2), to evaluate existing undocumented fill thicknesses. Previous subsurface investigations within the areas described above were limited by mining and asphalt production equipment and surface improvements, which have now been dismantled or demolished. However, locations of new borings were restricted by the remaining active business in lease area 8, the active high-pressure gas main crossing lease areas 8, 9, and 10, concrete paving in lease area 12, and in-service water lines which could not be accurately located by private-utility locators.

SOIL AND GEOLOGIC CONDITIONS

Within and adjacent to lease area 5, we encountered undocumented fill overlying compacted fill, alluvium and the Stadium Conglomerate Formation. Formational material was encountered at depths ranging from 2- to approximately 30-feet below site grades. Borings were advanced into the Stadium Conglomerate, unless boring depth was limited by caving and/or water intrusion.

The soil and geologic units encountered during our recent subsurface investigation are described below. The approximate lateral extent of surficial soils and geologic formational units and recommended remedial-grading depths are shown on our *Geologic Map* (see Figure 2).

Undocumented Fill (Qudf)

Undocumented fill associated with previous mining and grading activities will be removed across the whole site. The undocumented fill thickness ranges from a few feet to approximately 30 feet thick, and consists of reject asphalt, gravel, silty and clayey sand with cobble and gravel, and sandy clay.

Compacted Fill (Qcf)

Compacted fill placed during previous reclamation grading is present along the south side of lease area 5, adjacent to the grading limit for the park site. Compacted fill encountered in borings LB-18, -19, and -24 generally consisted of medium dense, moist, silty and clayey sand with cobble. Upper portions of the compacted fill may be saturated in some areas due to leaking water lines, which have since been bypassed. Saturated compacted fill, if encountered, should be removed during reclamation grading.

Alluvium (Qal)

Alluvium is present within the southern portion (Carroll Canyon Creek) of the site. The alluvium where observed, consists of sand, silts and clays with varying amounts of cobble. The alluvium will be removed and replaced as compacted fill with the exception of the southwest corner of the site where

no development is planned and along the south side of the park site where the alluvial thickness is generally less than 10 feet and there is at least 15 feet of documented compacted fill above the alluvium.

Stadium Conglomerate (Tst)

The Eocene-age Stadium Conglomerate is the predominant formational unit on the site and is mantled by varying thicknesses of documented and undocumented fill and alluvium. During our recent investigation, Stadium Conglomerate was encountered at depths ranging from 2- to approximately 30-feet below site grades. In general, the Stadium Conglomerate consists of dense to very dense, yellow to light brown, cobble conglomerate.

If you have any questions regarding this letter, or if we may be of further service, please contact the undersigned at your convenience.

Very truly yours,

GEOCON INCORPORATED

Rupert S. Adams
CEG 2561

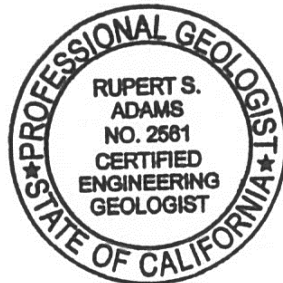

RSA:RCM:dmc

(3/del) Addressee

Rodney C. Mikesell
GE 2533



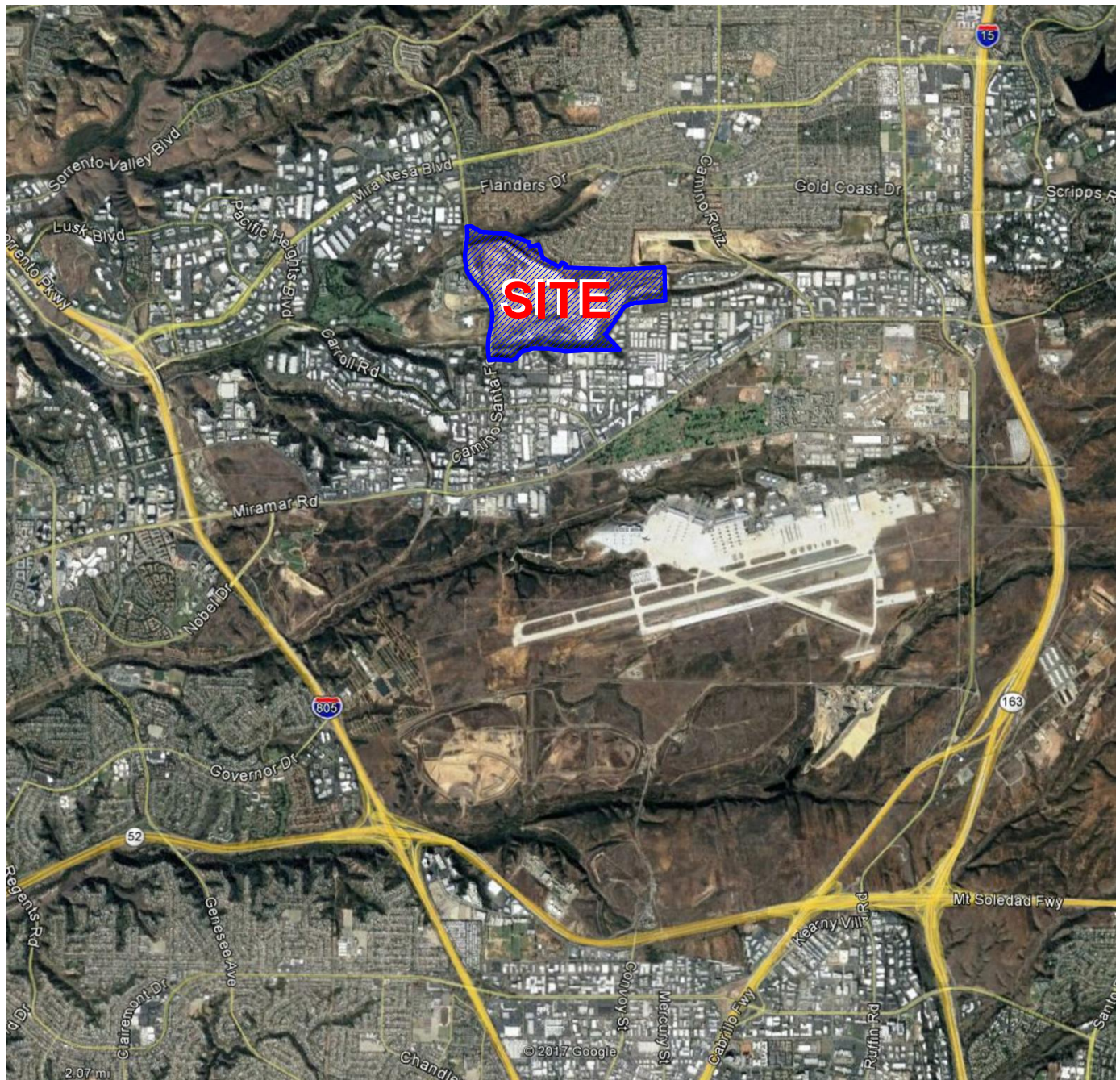

THE GEOGRAPHICAL INFORMATION MADE AVAILABLE FOR DISPLAY WAS PROVIDED BY GOOGLE EARTH, SUBJECT TO A LICENSING AGREEMENT. THE INFORMATION IS FOR ILLUSTRATIVE PURPOSES ONLY; IT IS NOT INTENDED FOR CLIENT'S USE OR RELIANCE AND SHALL NOT BE REPRODUCED BY CLIENT. CLIENT SHALL INDEMNIFY, DEFEND AND HOLD HARMLESS GEOCON FROM ANY LIABILITY INCURRED AS A RESULT OF SUCH USE OR RELIANCE BY CLIENT.



NO SCALE

VICINITY MAP

GEOCON
INCORPORATED



GEOTECHNICAL ■ ENVIRONMENTAL ■ MATERIALS
6960 FLANDERS DRIVE - SAN DIEGO, CALIFORNIA 92121 - 2974
PHONE 858 558-6900 - FAX 858 558-6159

3ROOTS
SAN DIEGO, CALIFORNIA

RM / AML

DSK/GTYPD

DATE 02 - 06 - 2018

PROJECT NO. G2070 - 42 - 03

FIG. 1

APPENDIX

A

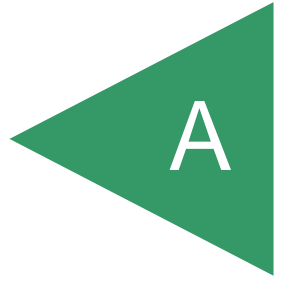

APPENDIX A

FIELD INVESTIGATION

Fieldwork for our investigations included subsurface exploration and soil sampling. The approximate locations of the exploratory borings and trenches are shown on the *Geologic Map*, Figure 2. We located the borings in the field using existing site reference points. Therefore, actual boring and trench locations may deviate slightly.

We performed our recent field investigations between January 22 and January 25, 2019. Our recent explorations consisted of drilling and downhole logging (where subsurface conditions permitted) 12 large-diameter bucket auger borings. The large-diameter borings were advanced using an EZ Bore bucket auger drill rig equipped with a 30-inch-diameter bucket. Boring depths ranged from approximately 5- to 30-feet below existing site grades.

We visually examined, classified and logged the soil conditions encountered in the borings in general accordance with American Society for Testing and Materials (ASTM) practice for Description and Identification of Soils (Visual-Manual Procedure D 2488). Logs of the exploratory borings and trenches are presented on Figures A-1 through A-12. The logs depict the soil and geologic conditions encountered and the depth at which samples were obtained. Elevations shown on the logs were based on existing elevations shown on plans provided for our use. Logs of the other borings and trenches shown on Figure 2 are contained in Reference 1.









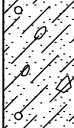

DEPTH IN FEET	SAMPLE NO.	LITHOLOGY	GROUNDWATER	SOIL CLASS (USCS)	BORING LB 18		PENETRATION RESISTANCE (BLOWS/FT.)	DRY DENSITY (P.C.F.)	MOISTURE CONTENT (%)
					ELEV. (MSL.) <u>+/-268.5</u>	DATE COMPLETED <u>01-22-2019</u>			
					EQUIPMENT _____ BY: <u>R. ADAMS</u>				
MATERIAL DESCRIPTION									
0	LB18-1			GM	UNDOCUMENTED FILL (Qudf) Loose to medium dense, damp, grayish-brown, medium to coarse grained SAND with cobble; trace silt				
2									
4				GC	COMPACTED FILL (Qcf) Firm, moist, dark brown, Clayey GRAVEL; 30-40% cobble up to 12" diameter		3/8"		
6				GC	ALLUVIUM (Qal) Medium dense, wet, dark gray Clayey, medium to coarse grained SAND with cobble -Heavy seepage at 6.5 feet				
8									
10				GC	STADIUM CONGLOMERATE (Tst) Dense, wet, brown to grayish-brown and bluish-gray (mottled) COBBLE CONGLOMERATE				
					TERMINATED AT 11 FEET Groundwater at 6.5 feet Not downhole logged due to caving and rapid water intrusion Backfilled 01-22-2019				

Figure A-1,
Log of Boring LB 18, Page 1 of 1

G2070-42-03.GPJ

SAMPLE SYMBOLS		... SAMPLING UNSUCCESSFUL		... STANDARD PENETRATION TEST		... DRIVE SAMPLE (UNDISTURBED)
		... DISTURBED OR BAG SAMPLE		... CHUNK SAMPLE		... WATER TABLE OR SEEPAGE

NOTE: THE LOG OF SUBSURFACE CONDITIONS SHOWN HEREON APPLIES ONLY AT THE SPECIFIC BORING OR TRENCH LOCATION AND AT THE DATE INDICATED. IT IS NOT WARRANTED TO BE REPRESENTATIVE OF SUBSURFACE CONDITIONS AT OTHER LOCATIONS AND TIMES.

DEPTH IN FEET	SAMPLE NO.	LITHOLOGY	GROUNDWATER	SOIL CLASS (USCS)	BORING LB 19		PENETRATION RESISTANCE (BLOWS/FT.)	DRY DENSITY (P.C.F.)	MOISTURE CONTENT (%)	
					ELEV. (MSL.) <u>+/-261.5</u>	DATE COMPLETED <u>01-22-2019</u>				
					EQUIPMENT _____ BY: <u>R. ADAMS</u>					
MATERIAL DESCRIPTION										
0				SM-GM	UNDOCUMENTED FILL (Qudf) Medium dense, moist, orange-brown, Silty, fine to coarse grained SAND with gravel					
2			GM-GC	Medium dense, moist, brown to gray-brown, Clayey, medium to coarse grained SAND with cobble; cobble up to (20%) 6"-10" diameter						
4			GC	COMPACTED FILL (Qcf) Medium dense, damp, black Sandy CLAY; organic odor, trace cobble up to 12" diameter -At 6 feet: trace decaying plant material, e.g.e. roots, bark						
6										
8										
10			SC	Medium dense, moist to wet, grayish-brown, Clayey SAND; trace cobble (10-20%) up to 4"-6" diameter						
12			GC	Medium dense to dense, moist, black, Sandy CLAY with cobble -At 12 feet: hard drilling						
14										
16										
18						Medium dense, moist to wet, grayish-black, Clayey, medium to coarse grained SAND with cobble; light seepage at 15 feet; some broken roots and other decaying organic debris				
20										
22					GM	STADIUM CONGLOMERATE (Tst) Very dense, damp, orange-brown, Silty, COBBLE CONGLOMERATE				
					TERMINATED AT 22 FEET Seepage at 15 feet Backfilled 01-22-2019					

Figure A-2,
Log of Boring LB 19, Page 1 of 1

G2070-42-03.GPJ







SAMPLE SYMBOLS	... SAMPLING UNSUCCESSFUL	... STANDARD PENETRATION TEST	... DRIVE SAMPLE (UNDISTURBED)
	... DISTURBED OR BAG SAMPLE	... CHUNK SAMPLE	... WATER TABLE OR SEEPAGE

NOTE: THE LOG OF SUBSURFACE CONDITIONS SHOWN HEREON APPLIES ONLY AT THE SPECIFIC BORING OR TRENCH LOCATION AND AT THE DATE INDICATED. IT IS NOT WARRANTED TO BE REPRESENTATIVE OF SUBSURFACE CONDITIONS AT OTHER LOCATIONS AND TIMES.

DEPTH IN FEET	SAMPLE NO.	LITHOLOGY	GROUNDWATER	SOIL CLASS (USCS)	BORING LB 20		PENETRATION RESISTANCE (BLOWS/FT.)	DRY DENSITY (P.C.F.)	MOISTURE CONTENT (%)
					ELEV. (MSL.) <u>+/-264.5</u>	DATE COMPLETED <u>01-22-2019</u>			
					EQUIPMENT _____ BY: <u>R. ADAMS</u>				
					MATERIAL DESCRIPTION				
0					REJECT A/C				
2				SM	Loose, damp, grayish-brown, Silty, fine to coarse grained SAND with cobble and gravel; cobble up to 12" diameter				
4				SM	STADIUM CONGLOMERATE (Tst) Medium dense, damp, pale yellowish-brown, Silty, fine to medium grained SAND; trace cobble				
6	LB20-1				TERMINATED AT 6 FEET No groundwater Backfilled 01-22-2019				

Figure A-3,
Log of Boring LB 20, Page 1 of 1

G2070-42-03.GPJ

SAMPLE SYMBOLS	 ... SAMPLING UNSUCCESSFUL	 ... STANDARD PENETRATION TEST	 ... DRIVE SAMPLE (UNDISTURBED)
	 ... DISTURBED OR BAG SAMPLE	 ... CHUNK SAMPLE	 ... WATER TABLE OR SEEPAGE

NOTE: THE LOG OF SUBSURFACE CONDITIONS SHOWN HEREON APPLIES ONLY AT THE SPECIFIC BORING OR TRENCH LOCATION AND AT THE DATE INDICATED. IT IS NOT WARRANTED TO BE REPRESENTATIVE OF SUBSURFACE CONDITIONS AT OTHER LOCATIONS AND TIMES.







DEPTH IN FEET	SAMPLE NO.	LITHOLOGY	GROUNDWATER	SOIL CLASS (USCS)	BORING LB 21 ELEV. (MSL.) <u>+/-264</u> DATE COMPLETED <u>01-22-2019</u> EQUIPMENT _____ BY: <u>R. ADAMS</u>	PENETRATION RESISTANCE (BLOWS/FT.)	DRY DENSITY (P.C.F.)	MOISTURE CONTENT (%)
0					MATERIAL DESCRIPTION			
2					REJECT A/C			
4				GM	STADIUM CONGLOMERATE (Tst) Dense, damp, pale yellowish-brown Sandy COBBLE CONGLOMERATE			
					TERMINATED AT 5 FEET No groundwater Backfilled 01-22-2019			

Figure A-4,
Log of Boring LB 21, Page 1 of 1

G2070-42-03.GPJ

SAMPLE SYMBOLS  ... SAMPLING UNSUCCESSFUL  ... DISTURBED OR BAG SAMPLE	 ... STANDARD PENETRATION TEST  ... CHUNK SAMPLE	 ... DRIVE SAMPLE (UNDISTURBED)  ... WATER TABLE OR SEEPAGE
--	---	--

NOTE: THE LOG OF SUBSURFACE CONDITIONS SHOWN HEREON APPLIES ONLY AT THE SPECIFIC BORING OR TRENCH LOCATION AND AT THE DATE INDICATED. IT IS NOT WARRANTED TO BE REPRESENTATIVE OF SUBSURFACE CONDITIONS AT OTHER LOCATIONS AND TIMES.

DEPTH IN FEET	SAMPLE NO.	LITHOLOGY	GROUNDWATER	SOIL CLASS (USCS)	BORING LB 22		PENETRATION RESISTANCE (BLOWS/FT.)	DRY DENSITY (P.C.F.)	MOISTURE CONTENT (%)
					ELEV. (MSL.) <u>267'</u>	DATE COMPLETED <u>01-22-2019</u>			
					EQUIPMENT _____	BY: <u>R. ADAMS</u>			
MATERIAL DESCRIPTION									
0				SM	UNDOCUMENTED FILL (Qudf) Loose, dry, pale yellowish-brown, Silty, fine grained SAND; trace angular gravel				
2									
4									
6				GM	ALLUVIUM (Qal) Loose to medium dense, damp, orange-brown to reddish-brown, Silty, fine to medium grained SAND; trace gravel, some cobble up to 6" diameter -At 6 to 8 feet: caving/belling-hole approximately 8' wide -At 8 feet: becomes clayey sand with cobble				
8									
10									
12									
14				GM	STADIUM CONGLOMERATE (Tst) Medium dense to dense, damp, orange-brown, Silty COBBLE CONGLOMERATE				
						TERMINATED AT 15 FEET No groundwater encountered Backfilled 01-23-2019			

Figure A-5,
Log of Boring LB 22, Page 1 of 1

G2070-42-03.GPJ

SAMPLE SYMBOLS	... SAMPLING UNSUCCESSFUL	... STANDARD PENETRATION TEST	... DRIVE SAMPLE (UNDISTURBED)
	... DISTURBED OR BAG SAMPLE	... CHUNK SAMPLE	... WATER TABLE OR SEEPAGE

NOTE: THE LOG OF SUBSURFACE CONDITIONS SHOWN HEREON APPLIES ONLY AT THE SPECIFIC BORING OR TRENCH LOCATION AND AT THE DATE INDICATED. IT IS NOT WARRANTED TO BE REPRESENTATIVE OF SUBSURFACE CONDITIONS AT OTHER LOCATIONS AND TIMES.

DEPTH IN FEET	SAMPLE NO.	LITHOLOGY	GROUNDWATER	SOIL CLASS (USCS)	BORING LB 23		PENETRATION RESISTANCE (BLOWS/FT.)	DRY DENSITY (P.C.F.)	MOISTURE CONTENT (%)
					ELEV. (MSL.) <u>+/-267</u>	DATE COMPLETED <u>01-23-2019</u>			
					EQUIPMENT _____	BY: <u>R. ADAMS</u>			
MATERIAL DESCRIPTION									
0				SM	UNDOCUMENTED FILL (Qudf) Loose, dry to damp, pale yellowish-brown, Silty, fine to coarse grained SAND with gravel; trace cobble				
2				SC	Loose to medium dense, orange-brown, Clayey, fine to medium grained SAND; some cobble				
4				GM	STADIUM CONGLOMERATE (Tst) Very dense, damp, orange-brown to yellowish-brown (mottled) Sandy, COBBLE CONGLOMERATE				
6									
8									
					TRENCH TERMINATED AT 9.5 FEET No groundwater Backfilled 01-23-2019				

Figure A-6,
Log of Boring LB 23, Page 1 of 1

G2070-42-03.GPJ

SAMPLE SYMBOLS	... SAMPLING UNSUCCESSFUL	... STANDARD PENETRATION TEST	... DRIVE SAMPLE (UNDISTURBED)
	... DISTURBED OR BAG SAMPLE	... CHUNK SAMPLE	... WATER TABLE OR SEEPAGE

NOTE: THE LOG OF SUBSURFACE CONDITIONS SHOWN HEREON APPLIES ONLY AT THE SPECIFIC BORING OR TRENCH LOCATION AND AT THE DATE INDICATED. IT IS NOT WARRANTED TO BE REPRESENTATIVE OF SUBSURFACE CONDITIONS AT OTHER LOCATIONS AND TIMES.

DEPTH IN FEET	SAMPLE NO.	LITHOLOGY	GROUNDWATER	SOIL CLASS (USCS)	BORING LB 24		PENETRATION RESISTANCE (BLOWS/FT.)	DRY DENSITY (P.C.F.)	MOISTURE CONTENT (%)
					ELEV. (MSL.) <u>+/-275</u>	DATE COMPLETED <u>01-23-2019</u>			
					EQUIPMENT _____ BY: <u>R. ADAMS</u>				
MATERIAL DESCRIPTION									
0				SM	UNDOCUMENTED FILL (Qudf)				
2				SC	Loose, moist, pale yellowish-brown, Silty, fine to medium grained SAND with gravel				
4				CL	Medium dense, moist, brown, Clayey fine to coarse grained SAND with cobble				
6						Soft to firm, moist to wet, yellowish-brown, Sandy CLAY; some cobble and gravel			
8									
10				GM	STADIUM CONGLOMERATE (Tst)				
					Dense, damp, pale yellow orange to orange-brown (mottled) Silty, COBBLE CONGLOMERATE				
					TRENCH TERMINATED AT 11 FEET No groundwater Backfilled 01-23-2019				

Figure A-7,
Log of Boring LB 24, Page 1 of 1

G2070-42-03.GPJ

SAMPLE SYMBOLS	... SAMPLING UNSUCCESSFUL	... STANDARD PENETRATION TEST	... DRIVE SAMPLE (UNDISTURBED)
	... DISTURBED OR BAG SAMPLE	... CHUNK SAMPLE	... WATER TABLE OR SEEPAGE

NOTE: THE LOG OF SUBSURFACE CONDITIONS SHOWN HEREON APPLIES ONLY AT THE SPECIFIC BORING OR TRENCH LOCATION AND AT THE DATE INDICATED. IT IS NOT WARRANTED TO BE REPRESENTATIVE OF SUBSURFACE CONDITIONS AT OTHER LOCATIONS AND TIMES.

DEPTH IN FEET	SAMPLE NO.	LITHOLOGY	GROUNDWATER	SOIL CLASS (USCS)	BORING LB 25		PENETRATION RESISTANCE (BLOWS/FT.)	DRY DENSITY (P.C.F.)	MOISTURE CONTENT (%)
					ELEV. (MSL.) <u>+/-267</u>	DATE COMPLETED <u>01-23-2019</u>			
					EQUIPMENT _____	BY: <u>R. ADAMS</u>			
MATERIAL DESCRIPTION									
0				GC	UNDOCUMENTED FILL (Qudf) Medium dense, moist, brown to dark brown, Clayey, fine to coarse grained SAND with cobble				
2									
4				GM	Loose, dry, brown, Silty, fine to medium grained SAND with cobble				
6				GC	Very soft to soft, moist to wet, brown to orange-brown, Clayey, fine to coarse grained SAND with cobble				
8									
10									
12				CL-CH	Very soft, wet, grayish-black, Sandy CLAY; abundant organic debris, trace cobble				
14									
16									
18									
20									
22									
24					-At 26.5 feet: becomes black				
26									
28					ALLUVIUM (Qal) Loose, wet, dark grayish black, Silty, fine to coarse grained SAND; some cobble, caving below 28'				
30									
32					TERMINATED AT 32 FEET Groundwater at 28 feet Backfilled 01-23-2019				

Figure A-8,
Log of Boring LB 25, Page 1 of 1

G2070-42-03.GPJ

SAMPLE SYMBOLS		... SAMPLING UNSUCCESSFUL		... STANDARD PENETRATION TEST		... DRIVE SAMPLE (UNDISTURBED)
		... DISTURBED OR BAG SAMPLE		... CHUNK SAMPLE		... WATER TABLE OR SEEPAGE

NOTE: THE LOG OF SUBSURFACE CONDITIONS SHOWN HEREON APPLIES ONLY AT THE SPECIFIC BORING OR TRENCH LOCATION AND AT THE DATE INDICATED. IT IS NOT WARRANTED TO BE REPRESENTATIVE OF SUBSURFACE CONDITIONS AT OTHER LOCATIONS AND TIMES.

DEPTH IN FEET	SAMPLE NO.	LITHOLOGY	GROUNDWATER	SOIL CLASS (USCS)	BORING LB 26		PENETRATION RESISTANCE (BLOWS/FT.)	DRY DENSITY (P.C.F.)	MOISTURE CONTENT (%)
					ELEV. (MSL.) <u>+/-260</u>	DATE COMPLETED <u>01-25-2019</u>			
					EQUIPMENT _____ BY: <u>R. ADAMS</u>				
MATERIAL DESCRIPTION									
0					REJECT A/C				
2				SC	UNDOCUMENTED FILL (Qudf) Gravel with 2"-3" diameter PVC pipe Medium dense, wet, orange-brown, Clayey SAND; some cobble -At 5 feet: 2"-3" diameter PVC pipe				
4				GC	STADIUM CONGLOMERATE (Tst) Dense, wet, orange-brown, Clayey, COBBLE CONGLOMERATE				
6									
8									
					TERMINATED AT 9 FEET No groundwater encountered Backfilled 01-25-2019				

Figure A-9,
Log of Boring LB 26, Page 1 of 1

G2070-42-03.GPJ

SAMPLE SYMBOLS	■	... SAMPLING UNSUCCESSFUL	□	... STANDARD PENETRATION TEST	■	... DRIVE SAMPLE (UNDISTURBED)
	⊠	... DISTURBED OR BAG SAMPLE	▣	... CHUNK SAMPLE	▼	... WATER TABLE OR SEEPAGE

NOTE: THE LOG OF SUBSURFACE CONDITIONS SHOWN HEREON APPLIES ONLY AT THE SPECIFIC BORING OR TRENCH LOCATION AND AT THE DATE INDICATED. IT IS NOT WARRANTED TO BE REPRESENTATIVE OF SUBSURFACE CONDITIONS AT OTHER LOCATIONS AND TIMES.









DEPTH IN FEET	SAMPLE NO.	LITHOLOGY	GROUNDWATER	SOIL CLASS (USCS)	BORING LB 27 ELEV. (MSL.) <u>+/-261.5'</u> DATE COMPLETED <u>01-25-2019</u> EQUIPMENT _____ BY: <u>R. ADAMS</u>	PENETRATION RESISTANCE (BLOWS/FT.)	DRY DENSITY (P.C.F.)	MOISTURE CONTENT (%)
0					MATERIAL DESCRIPTION			
0 - 2				SM	UNDOCUMENTED FILL (Qudf) Loose, wet, orange-brown, Silty, fine to medium grained SAND with gravel; trace cobble			
2 - 4				GM	STADIUM CONGLOMERATE (Tst) Medium dense to dense, moist to wet, orange-brown, SANDY COBBLE CONGLOMERATE			
4					TERMINATED AT 4 FEET No groundwater Backfilled 1-25-2019			

Figure A-10,
Log of Boring LB 27, Page 1 of 1

G2070-42-03.GPJ

SAMPLE SYMBOLS		... SAMPLING UNSUCCESSFUL		... STANDARD PENETRATION TEST		... DRIVE SAMPLE (UNDISTURBED)
		... DISTURBED OR BAG SAMPLE		... CHUNK SAMPLE		... WATER TABLE OR SEEPAGE

NOTE: THE LOG OF SUBSURFACE CONDITIONS SHOWN HEREON APPLIES ONLY AT THE SPECIFIC BORING OR TRENCH LOCATION AND AT THE DATE INDICATED. IT IS NOT WARRANTED TO BE REPRESENTATIVE OF SUBSURFACE CONDITIONS AT OTHER LOCATIONS AND TIMES.

DEPTH IN FEET	SAMPLE NO.	LITHOLOGY	GROUNDWATER	SOIL CLASS (USCS)	BORING LB 28		PENETRATION RESISTANCE (BLOWS/FT.)	DRY DENSITY (P.C.F.)	MOISTURE CONTENT (%)
					ELEV. (MSL.) <u>+/-260</u>	DATE COMPLETED <u>01-25-2019</u>			
					EQUIPMENT _____ BY: <u>R. ADAMS</u>				
MATERIAL DESCRIPTION									
0				SC	REJECT A/C				
2				SC-GC	COMPACTED FILL (Qcf) Medium dense, damp to moist, orange-brown, Clayey, fine to medium grained SAND; trace cobble				
4					Medium dense, damp to moist, orange-brown to grayish black, Clayey, fine to coarse SAND; some cobble				
6									
8									
10					-At 9 feet: becomes moist to wet				
12				GM	STADIUM CONGLOMERATE (Tst) Very dense, damp, orange-brown, Silty, fine to medium grained SANDY COBBLE CONGLOMERATE				
					TERMINATED AT 12 FEET No groundwater Backfilled 01-25-2019				

Figure A-11,
Log of Boring LB 28, Page 1 of 1

G2070-42-03.GPJ

SAMPLE SYMBOLS	... SAMPLING UNSUCCESSFUL	... STANDARD PENETRATION TEST	... DRIVE SAMPLE (UNDISTURBED)
	... DISTURBED OR BAG SAMPLE	... CHUNK SAMPLE	... WATER TABLE OR SEEPAGE

NOTE: THE LOG OF SUBSURFACE CONDITIONS SHOWN HEREON APPLIES ONLY AT THE SPECIFIC BORING OR TRENCH LOCATION AND AT THE DATE INDICATED. IT IS NOT WARRANTED TO BE REPRESENTATIVE OF SUBSURFACE CONDITIONS AT OTHER LOCATIONS AND TIMES.

DEPTH IN FEET	SAMPLE NO.	LITHOLOGY	GROUNDWATER	SOIL CLASS (USCS)	BORING LB 29		PENETRATION RESISTANCE (BLOWS/FT.)	DRY DENSITY (P.C.F.)	MOISTURE CONTENT (%)
					ELEV. (MSL.) <u>+/-263</u>	DATE COMPLETED <u>01-25-2019</u>			
					EQUIPMENT _____	BY: <u>R. ADAMS</u>			
MATERIAL DESCRIPTION									
0					UNDOCUMENTED FILL (Qudf) Loose, dry to damp, pale yellowish brown, Silty, fine to medium grained SAND; trace gravel				
2					-At 3 feet: becomes grayish-brown				
4				SM	Medium dense, dry, red to reddish-brown, Silty, fine grained SAND; trace rounded gravel <4", trace cobble				
6					-At 8 feet: caving/belling				
8									
10									
12				SM-GM	Loose to medium dense, damp, grayish-brown, Silty, fine to coarse grained SAND; some cobble, trace clay				
14					TERMINATED AT 14 FEET; (REFUSAL DUE TO CAVING) No groundwater Backfilled 01-25-2019				

Figure A-12,
Log of Boring LB 29, Page 1 of 1

G2070-42-03.GPJ

SAMPLE SYMBOLS		... SAMPLING UNSUCCESSFUL		... STANDARD PENETRATION TEST		... DRIVE SAMPLE (UNDISTURBED)
		... DISTURBED OR BAG SAMPLE		... CHUNK SAMPLE		... WATER TABLE OR SEEPAGE

NOTE: THE LOG OF SUBSURFACE CONDITIONS SHOWN HEREON APPLIES ONLY AT THE SPECIFIC BORING OR TRENCH LOCATION AND AT THE DATE INDICATED. IT IS NOT WARRANTED TO BE REPRESENTATIVE OF SUBSURFACE CONDITIONS AT OTHER LOCATIONS AND TIMES.

GEO TECHNICAL INVESTIGATION

3ROOTS CARROLL CANYON ROAD WEST OFF-SITE IMPROVEMENTS SAN DIEGO, CALIFORNIA



GEOCON
INCORPORATED

GEOTECHNICAL
ENVIRONMENTAL
MATERIALS

PREPARED FOR

**MESA COMMUNITY PARTNERS, LLC, AND
CALATLANTIC GROUP, INC.,
A DELAWARE CORPORATION
SAN DIEGO, CALIFORNIA**

**AUGUST 7, 2018
PROJECT NO. G2070-42-02**



Project No. G2070-42-02
August 7, 2018

Mesa Community Partners, LLC, and
CalAtlantic Group, Inc., A Delaware Corporation
16465 Via Esprillo, Suite 150
San Diego, California 92127

Attention: Mr. Ryan Green

Subject: GEOTECHNICAL INVESTIGATION
3ROOTS
CARROLL CANYON ROAD WEST
OFF-SITE IMPROVEMENTS
SAN DIEGO, CALIFORNIA

Dear Mr. Green:

In accordance with your authorization, we have performed a geotechnical investigation for the subject off-site roadway improvements located in San Diego, California. The accompanying report presents the findings of our study and recommendations relative to the geotechnical aspects of constructing the roadway improvements as presently proposed. It is our opinion, based on the results of this study, that the site is suitable for the planned improvements.

Should you have questions regarding this investigation, or if we may be of further service, please contact the undersigned at your convenience.

Very truly yours,

GEOCON INCORPORATED

Rodney C. Mikesell
GE 2533



Troy K. Reist
CEG 2408



RCM:TKR:dmc

(e-mail) Addressee
(3/del) Project Design Consultants
Attention: Ms. Marina Wurst
(e-mail) Ms. Allegra Parisi

TABLE OF CONTENTS

1.	PURPOSE AND SCOPE	1
2.	PREVIOUS SITE DEVELOPMENT	1
3.	SITE AND PROJECT DESCRIPTION	2
4.	SOIL AND GEOLOGIC CONDITIONS	2
4.1	Undocumented Fill (Qudf)	2
4.2	Compacted Fill (Qcf)	2
4.3	Topsoil (Unmapped)	3
4.4	Alluvium (Qal)	3
4.5	Colluvium (Qc)	3
4.6	Stadium Conglomerate (Tst)	3
5.	GROUNDWATER/SEEPAGE	4
6.	CONCLUSIONS AND RECOMMENDATIONS	5
6.1	General	5
6.2	Soil and Excavation Characteristics	5
6.3	Impacts to Existing Sewer Main	6
6.4	Settlement Monitoring	7
6.5	Grading Recommendations	7
6.6	Slopes	9
6.7	Preliminary Pavement Recommendations	9
6.8	Retaining Walls and Lateral Loads	10
6.9	Slope Maintenance	12
6.10	Site Drainage and Moisture Protection	13
6.11	Plan Review	14

LIMITATIONS AND UNIFORMITY OF CONDITIONS

MAPS AND ILLUSTRATIONS

- Figure 1, Vicinity Map
- Figure 2, Geologic Map
- Figure 3, Settlement Monument Detail
- Figure 4, Slope Stability Analysis – Cut Slopes
- Figure 5, Slope Stability Analysis – Fill Slopes
- Figure 6, Surficial Slope Stability Analysis
- Figure 7, Typical Retaining Wall Drain Detail

APPENDIX A

FIELD INVESTIGATION

- Figures A-1 – A-2, Logs of Large-Diameter Borings (LB-1 and LB-2)
- Figures A-3 – A-13, Logs of Exploratory Trenches (T-1 through T-11)
- Logs of Previous Small-Diameter Borings performed in June 2001 (B-1 and B-2)

APPENDIX B

LABORATORY TESTING

- Table B-I, Summary of Laboratory Resistance Value (R-Value) Test Results
- Figure B-1, Consolidation Curve

APPENDIX C

RECOMMENDED GRADING SPECIFICATIONS

LIST OF REFERENCES

GEOTECHNICAL INVESTIGATION

1. PURPOSE AND SCOPE

This report presents the results of our geotechnical investigation for the proposed Carroll Canyon Road West Off-Site Improvement project for the 3Roots development located in the Mira Mesa area of San Diego, California (see *Vicinity Map*, Figure 1). The purpose of the geotechnical investigation was to evaluate the surface and subsurface soil and geologic conditions and provide recommendations for the proposed improvements.

The scope of our study consisted of the following:

- Reviewing aerial photographs and readily available published and unpublished geologic literature.
- Reviewing the project plans prepared by Project Design Consultants.
- Down-hole logging and sampling of two large-diameter borings and excavating eleven exploratory trenches using a rubber tire backhoe to evaluate the general extent and condition of surficial deposits (see Appendix A). The logs of two small-diameter borings performed during a previous study for Camino Santa Fe are also contained in Appendix A.
- Performing laboratory tests on selected soil samples collected to evaluate their physical properties (see Appendix B).
- Preparing this report presenting our exploratory information and our conclusions and recommendations regarding geotechnical aspects of constructing the improvements as presently proposed. The approximate locations of the previous and recent subsurface information are shown on the *Geologic Map*, Figure 2.

2. PREVIOUS SITE DEVELOPMENT

A portion of the existing roadway alignment, Camino Santa Fe and adjacent property to the north (part of the Fenton Carroll Canyon, Technology Center) were previously graded between the 1980's and 2003. Testing and observation services were provided by Geocon Incorporated (see *List of References*). Grading for the subject roadway consisted of the removal of brush and vegetation from the area to be graded. The brush and vegetation were exported. Loose surficial deposits (topsoil, undocumented fill, alluvium, colluvium) were removed to a firm competent surface or to within 2 feet of the groundwater table, whichever occurred first. Fill soils derived from onsite operations were then placed and compacted to the desired finish grade elevations.

Since our initial testing and observation services were performed, additional fill material has been placed within the roadway alignment. Documentation for the additional fill placement could not be found, therefore, we have mapped these deposits as undocumented fill.

3. SITE AND PROJECT DESCRIPTION

The site is located west of the intersection of Camino Santa Fe and Carroll Canyon Road. The proposed western extension of Carroll Canyon Road currently consists of a paved utility access road with an existing 24-inch trunk sewer main, storm drain and overhead power lines. Portions of the roadway alignment are currently utilized for storage and waste recycling bins.

It is our understanding that the proposed improvements will consist of extending Carroll Canyon Road approximately 2,000 feet to the west of the intersection of Camino Santa Fe with a 4-lane roadway bisected by a median with sidewalks on each side. In addition, an approximately 1,400-foot-long retaining wall with a maximum height of 16 feet will be constructed on the north side of the roadway. Cuts and fills up to approximately 30 feet will be required to achieve roadway grades.

The locations and descriptions provided herein are based on a review of available information and plans prepared by Project Design Consultants. If project details change significantly from those described herein, Geocon Incorporated should be contacted to evaluate potential impacts with respect to the site soil and geologic conditions and to determine if the proposed changes will require revision of this report.

4. SOIL AND GEOLOGIC CONDITIONS

The site is underlain by undocumented fill, compacted fill, topsoil, alluvium, colluvium, and the Stadium Conglomerate Formation. Each of the units is described below in order of increasing age. Their mapped extent (with the exception of topsoil) is shown on the *Geologic Map*.

4.1 Undocumented Fill (Qudf)

Undocumented fill associated with previous grading activities is present across the majority of the site. The undocumented fill thickness is expected to range from a few feet to approximately 10 feet thick. The undocumented fill is generally composed of silty to clayey sand with varying amounts of cobble. Undocumented fill will require removal and recompaction where improvements are planned.

4.2 Compacted Fill (Qcf)

Compacted fill placed during previous grading operations is present at the surface and beneath undocumented fill deposits within the majority of the eastern half of the proposed roadway alignment. Testing and observation services were performed by Geocon Incorporated as previously discussed. Based on our observations and laboratory testing, the compacted fill has a low potential for loading-induced compression and is considered suitable for support of planned improvements in its existing condition.

4.3 Topsoil (Unmapped)

Topsoil up to 3½ feet thick was encountered in Trench No. T-4. In general, the topsoil is characterized as loose to medium dense, brown, gravelly, fine to coarse sand with varying amounts of gravel and cobble. Topsoil deposits are considered unsuitable in their present condition and will require removal and compaction in areas planned to receive structural fill and/or settlement-sensitive structures.

4.4 Alluvium (Qal)

Alluvium is present within Carroll Canyon Creek and beneath the surficial deposits within the southern half of the proposed roadway alignment. The alluvium, where observed, consists of fine to medium grained sand with varying amounts of gravel and cobble. The upper portion of the alluvium is considered compressible and should be removed and replaced as compacted fill within structural improvement areas.

4.5 Colluvium (Qc)

Colluvium was encountered along the base of the natural hillside and is believed to underlie the surficial deposits within the northern half of the proposed roadway alignment. The colluvium consists of medium dense, gravelly to clayey sand and sandy gravel with varying amounts of gravel and cobble. The thickness of the colluvium varied from 6 feet to over 16 feet. Based on our field observations, the majority of the colluvium appears to be adequate for the support the anticipated structural loads. Therefore, only the upper compressible portions of the colluvium, if present, will require remedial grading.

4.6 Stadium Conglomerate (Tst)

The Eocene-age Stadium Conglomerate is the predominant formational unit on the site. In general, the Stadium Conglomerate consists of a dense to very dense, cobble conglomerate with interbedded silty sandstone. The deposit contains a relatively high percentage of rounded cobble (up to approximately 60 percent by weight) embedded in a silty to clayey, fine to medium sand soil matrix. The cobble typically ranges in size from approximately 3 to 12 inches, however, boulder size clasts up to 24 inches are also common.

The Stadium Conglomerate underlies the surficial soils on the property and is exposed along portions of the south facing slope. Cut slopes within the Stadium Conglomerate typically possess adequate factors of safety and is suitable for support of additional fill and structural loading.

5. GROUNDWATER/SEEPAGE

Perched groundwater and/or heavy seepage was encountered in the recent and previous borings. Groundwater and/or seepage should be anticipated where remedial grading is performed adjacent to Carroll Canyon Creek. It is not uncommon for groundwater or seepage conditions to develop where none previously existed. Groundwater elevations are dependent on seasonal precipitation, irrigation, land use, among other factors, and vary as a result. Proper surface drainage will be important to future performance of the project.

6. CONCLUSIONS AND RECOMMENDATIONS

6.1 General

- 6.1.1 No soil or geologic conditions were observed that would preclude the construction of the improvements as presently proposed provided that the recommendations of this report are followed.
- 6.1.2 The site is underlain by undocumented fill, compacted fill, topsoil, alluvium, colluvium and the Stadium Conglomerate formation. Undocumented fill, topsoil and upper loose portions of alluvium and colluvium should be removed and replaced as compacted fill. The alluvium and colluvium underlying the compacted fill within the eastern half of the roadway alignment is suitable in its present condition for support of new fill and/or structural loading based on our laboratory testing and previous observations and remedial grading performed.
- 6.1.3 Subsurface conditions observed may be extrapolated to reflect general soil/geologic conditions at the site; however, some variations in subsurface conditions between boring locations should be expected.
- 6.1.4 It is our opinion that the proposed development will not destabilize or result in settlement of adjacent properties.

6.2 Soil and Excavation Characteristics

- 6.2.1 Excavation of the surficial soils should be possible with moderate to heavy effort using conventional heavy-duty equipment. Excavation of the Stadium Conglomerate may require very heavy effort with conventional heavy-duty grading equipment to excavate and may generate oversized material. Oversized rock (rocks greater than 12 inches in dimension) can be incorporated into deep fill areas.
- 6.2.2 It is the responsibility of the contractor and their competent person to ensure that all excavations, temporary slopes and trenches are properly constructed and maintained in accordance with applicable OSHA regulations in order to maintain safety and the stability of adjacent existing improvements.
- 6.2.3 Geocon Incorporated does not practice in the field of corrosion engineering; therefore, further evaluation by a corrosion engineer may be needed to incorporate the necessary precautions to avoid premature corrosion of underground pipes and buried metal in direct contact with soil.

6.3 Impacts to Existing Sewer Main

- 6.3.1 The existing 24-inch trunk sewer main made of vitrified clay pipe located along the future roadway alignment will remain in place during and after the proposed improvements have been constructed. Within the eastern portion of the sewer alignment (approximate roadway Stations 58+00 to 65+00, fills will be placed to achieve roadway finish grade. Maximum fill thickness of 20 to 30 feet will be placed. The sewer main should be evaluated to verify the pipe can handle the pressure from the additional fill loads.
- 6.3.2 Based on invert elevations on the pipe and information obtained from our exploratory borings (LB-1 and LB-2), approximately 3 to 5 feet of alluvium may underlie the sewer main below the compacted fill within the eastern portion of the alignment. Consolidation tests in the alluvium indicate a low potential for loading induced compression. However, we expect with the addition of 20 to 30 feet of fill, there could be some settlement that occurs in the alluvium as a result of the fill placement. Based on available information, the pipe has a gradient varying from approximately 0.76 percent to 3.1 percent within the area of proposed new fill. Table 6.3 provides an estimate of settlement below the sewer main as a result of the additional fill load. The pipe should be evaluated to determine if settlement below the pipe could impact the sewer.

**TABLE 6.3
ESTIMATED ALLUVIAL SETTLEMENT ALONG ROADWAY ALIGNMENT
DUE TO FILL PLACEMENT**

Roadway Station	Estimated New Fill Thickness (feet)	Estimated Settlement (inches)
58+00 to 59+00	3	0.4
59+00 to 60+00	8	0.9
60+00 to 61+00	14	1.5
61+00 to 62+50	26	2.3
62+50 to 63+50	20	2
63+50 to 64+50	20	2
64+50 to 65+00	10	1

- 6.3.3 Between approximate roadway Stations 46+00 to 55+00, the sewer is located outside of the roadway grading limits. In this area cuts from existing grade are proposed to reach roadway finish grade. As such, the planned grading and roadway construction should not impact the sewer along this portion of the alignment.

- 6.3.4 If the sewer main is to remain in-place, a camera should be used to evaluate the existing sewer condition and gradient both before and after grading.

6.4 Settlement Monitoring

- 6.4.1 Based on the proposed grading, a maximum of 20 to 30 feet of additional fill is proposed along the eastern portion of the roadway alignment. Although laboratory testing of the underlying alluvium indicated a low potential for loading induced compression, we recommend that settlement monuments be installed at the completion of grading in fill areas. The locations of monuments will be determined once 40-scale grading plans are available.
- 6.4.2 Remedial grading recommendations provided herein specify removal and compaction of undocumented fill, topsoil, alluvium, and colluvium. As such, adverse settlement associated with compressible deposits will be mitigated where these soils are completely removed. Where groundwater is present, removal of the surficial soils may be limited. Where complete removals cannot be performed, settlement monitoring as discussed herein may be required. Recommendations for settlement monitoring for these conditions, if they are present, can be provided during construction.
- 6.4.3 Figure 3 shows a typical settlement monument. We recommend surface settlement monuments be installed and monitored until the readings indicate settlement, as a result of fill placement, is essentially complete. Settlement monuments should be surveyed on a weekly basis. We estimate a settlement period of 1 to 2 months for settlement monitoring. The surveyed results should be provided to Geocon Incorporated to evaluate when settlement has essentially ceased.

6.5 Grading Recommendations

- 6.5.1 All grading should be performed in accordance with the *Recommended Grading Specifications* contained in Appendix C. Where the recommendations of this section conflict with those of Appendix C, **the recommendations of this section take precedence**. All earthwork should be observed and all fill tested for proper compaction by Geocon Incorporated.
- 6.5.2 Prior to commencing grading, a preconstruction conference should be held at the site with the owner or developer, grading contractor, civil engineer, City of San Diego representatives, and geotechnical engineer in attendance. Special soil handling and/or the grading plans can be discussed at that time.

- 6.5.3 Site preparation should begin with the removal of all deleterious material and vegetation. The depth of removal should be such that material exposed in cut and fill areas, or soils to be used as fill are relatively free of organic matter. Material generated during stripping should be exported from the site.
- 6.5.4 The undocumented fill, topsoil, and upper loose portions of alluvium and colluvium should be removed to expose the underlying Stadium Conglomerate or compacted fill prior to placing additional fill and/or structural loads. The actual extent of unsuitable soil removals will be determined in the field during grading by the geotechnical engineer and/or engineering geologist. The approximate elevation of the bedrock contact and approximate thickness of remedial grading at boring and trench locations is shown on Figure 2. Areas where alluvium or colluvium will be left in-place should be monitored with settlement monuments at the completion of grading.
- 6.5.5 The upper surface elevation of the documented compacted fill was not surveyed during the previous grading operation for the existing roadway. As such, the elevation at the top of documented fill is unknown, except where observed within our exploratory borings and trenches. Further evaluation and testing of the fill material may need to be performed during grading to determine the actual extent of remedial grading necessary for these areas.
- 6.5.6 Prior to placing fill, the base of excavations and surface of compacted fill should be scarified; moisture conditioned as necessary and compacted. Fill soils may then be placed and compacted in layers to the design finish grade elevations. In general, on-site soils are suitable for re-use as fill if free from vegetation, debris and other deleterious material. Layers of fill should be no thicker than will allow for adequate bonding and compaction. All fill, including scarified ground surfaces and backfill, should be compacted to at least 90 percent of laboratory maximum dry density as determined by ASTM Test Procedure D 1557 at or slightly above optimum moisture content. Overly wet materials will require drying and/or mixing with drier soils to facilitate proper compaction.
- 6.5.7 Import fill (if necessary) should consist of granular materials with a *very low* to *low* expansion potential (EI of 50 or less), be free of deleterious material or stones larger than 3 inches, and should be compacted as recommended herein. Geocon Incorporated should be notified of the import soil source and should be authorized to perform laboratory testing of import soil prior to its arrival at the site to evaluate its suitability as fill material.

6.6 Slopes

- 6.6.1 Slope stability analyses were performed for proposed cut and fill slopes for slope heights up to 30 feet (cut) and 40 feet (fill). The stability analyses were performed using simplified Janbu analysis. Our analyses utilized average drained direct shear strength parameters based on laboratory tests performed on our previous study for the overall 3Roots project to the east and our experience with similar soils. The analyses indicate the proposed cut and fill slopes will have calculated factors of safety in excess of 1.5 under static conditions for both deep-seated failure and shallow sloughing conditions. A summary of slope stability analyses is presented on Figures 4 through 6.
- 6.6.2 All cut slope excavations should be observed during grading by an engineering geologist to verify that soil and geologic conditions do not differ significantly from those anticipated.
- 6.6.3 The outer 15 feet (or a distance equal to the height of the slope, whichever is less) of fill slopes should be composed of properly compacted granular *soil* fill to reduce the potential for surficial sloughing. All slopes should be compacted by backrolling with a loaded sheepsfoot roller at vertical intervals not to exceed 4 feet and should be track-walked at the completion of each slope such that the fill soils are uniformly compacted to at least 90 percent relative compaction to the face of the finished sloped.
- 6.6.4 All slopes should be landscaped with drought-tolerant vegetation, having variable root depths and requiring minimal landscape irrigation. In addition, all slopes should be drained and properly maintained to reduce erosion.

6.7 Preliminary Pavement Recommendations

- 6.7.1 We assume that the roadway will be subject to City of San Diego Schedule “J” paving standards. Table 6.7 shows the recommended pavement design section assuming the roadway is classified as a 4-Lane Major with a maximum average daily traffic of less than 30,000. This section is based on an R-Value between 20 and 29.9. This section is for preliminary budgeting. The final pavement section will be provided by the City of San Diego once grading and utility installation is complete and R-Values have been taken on actual subgrade soils.

**TABLE 6.7
PRELIMINARY FLEXIBLE PAVEMENT SECTIONS
BASED ON CITY OF SAN DIEGO SCHEDULE “J”**

Street Classification	Maximum ADT	Subgrade R-Value	Asphalt Concrete (inches)	Cement Treated Base (inches)
4-Lane Major	30,000	20 – 29.9	5	16

6.7.2 Asphalt concrete should conform to Section 203-6 of the *Standard Specifications for Public Works Construction* (Greenbook). Cement treated base (CTB) should conform to Section 301-3.3 of the “Greenbook” *Standard Specifications for Public Works Construction* and Section 400-5 of the *Regional Supplement to Greenbook*.

6.7.3 Prior to placing base materials, the upper 12 inches of the subgrade soil should be scarified, moisture conditioned as necessary, and recompacted to a dry density of at least 95 percent of the laboratory maximum dry density near to slightly above optimum moisture content as determined by ASTM D 1557. Similarly, the base material should be compacted to a dry density of at least 95 percent of the laboratory maximum dry density near to slightly above optimum moisture content. Asphalt concrete should be compacted to a density of at least 95 percent of the laboratory Hveem density in accordance with ASTM D 2726.

6.8 Retaining Walls and Lateral Loads

6.8.1 Retaining walls not restrained at the top and having a level backfill surface should be designed for an active soil pressure equivalent to the pressure exerted by a fluid with a density of 35 pounds per cubic foot (pcf). Where the backfill will be inclined at 2:1 (horizontal:vertical), an active soil pressure of 50 pcf is recommended. These soil pressures assume that the backfill materials within an area bounded by the wall and a 1:1 plane extending upward from the base of the wall possess an EI of 50 or less. Geocon Incorporated should be consulted for additional recommendations if backfill materials have an EI of 50 or less.

6.8.2 Where walls are restrained from movement at the top, an additional uniform pressure of 8H psf (where H equals the height of the retaining wall portion of the wall in feet) should be added to the active soil pressure where the wall possesses a height of 8 feet or less and 12H where the wall is greater than 8 feet. For retaining walls subject to vehicular loads within a horizontal distance equal to two-thirds the wall height, a surcharge equivalent to two feet of fill soil should be added (total unit weight of soil should be taken as 130 pcf).

- 6.8.3 Soil contemplated for use as retaining wall backfill, including import materials, should be identified in the field prior to backfill. At that time Geocon Incorporated should obtain samples for laboratory testing to evaluate its suitability. Modified lateral earth pressures may be necessary if the backfill soil does not meet the required expansion index or shear strength. City or regional standard wall designs, if used, are based on a specific active lateral earth pressure and/or soil friction angle. In this regard, on-site soil to be used as backfill may or may not meet the values for standard wall designs. Geocon Incorporated should be consulted to assess the suitability of the on-site soil for use as wall backfill if standard wall designs will be used.
- 6.8.4 Unrestrained walls will move laterally when backfilled and loading is applied. The amount of lateral deflection is dependent on the wall height, the type of soil used for backfill, and loads acting on the wall. The wall designer should provide appropriate lateral deflection quantities for planned retaining walls structures, if applicable. These lateral values should be considered when planning types of improvements above retaining wall structures.
- 6.8.5 Retaining walls should be provided with a drainage system adequate to prevent the buildup of hydrostatic forces and should be waterproofed as required by the project architect. The use of drainage openings through the base of the wall (weep holes) is not recommended where the seepage could be a nuisance or otherwise adversely affect the property adjacent to the base of the wall. The above recommendations assume a properly compacted granular (EI of 50 or less) free-draining backfill material with no hydrostatic forces or imposed surcharge load. A typical retaining wall drainage detail is presented on Figure 7. If conditions different than those described are expected, or if specific drainage details are desired, Geocon Incorporated should be contacted for additional recommendations.
- 6.8.6 In general, wall foundations having a minimum depth and width of one foot may be designed for an allowable soil bearing pressure of 2,500 psf, provided the soil within three feet below the base of the wall has an EI of 90 or less. The recommended allowable soil bearing pressure may be increased by 300 psf and 500 psf for each additional foot of foundation width and depth, respectively, up to a maximum allowable soil bearing pressure of 4,000 psf.
- 6.8.7 The proximity of the foundation to the top of a slope steeper than 3:1 could impact the allowable soil bearing pressure. Therefore, Geocon Incorporated should be consulted where such a condition is anticipated. As a minimum, wall footings should be deepened such that the bottom outside edge of the footing is at least seven feet from the face of slope when located adjacent and/or at the top of descending slopes.

- 6.8.8 The structural engineer should determine the seismic design category for the project in accordance with Section 1613 of the CBC. If the project possesses a seismic design category of D, E, or F, retaining walls that support more than 6 feet of backfill should be designed with seismic lateral pressure in accordance with Section 18.3.5.12 of the 2016 CBC. The seismic load is dependent on the retained height where H is the height of the wall, in feet, and the calculated loads result in pounds per square foot (psf) exerted at the base of the wall and zero at the top of the wall. A seismic load of $21H$ should be used for design. We used the peak ground acceleration adjusted for Site Class effects, PGA_M , of 0.439g calculated from ASCE 7-10 Section 11.8.3 and applied a pseudo-static coefficient of 0.33.
- 6.8.9 For resistance to lateral loads, a passive earth pressure equivalent to a fluid density of 300 pcf is recommended for footings or shear keys poured neat against properly compacted granular fill soils or undisturbed formation materials. The passive pressure assumes a horizontal surface extending away from the base of the wall at least five feet or three times the surface generating the passive pressure, whichever is greater. The upper 12 inches of material not protected by floor slabs or pavement should not be included in the design for lateral resistance. Where walls are planned adjacent to and/or on descending slopes, a passive pressure of 150 pcf should be used in design.
- 6.8.10 An ultimate friction coefficient of 0.35 may be used for resistance to sliding between soil and concrete. This friction coefficient may be combined with the passive earth pressure when determining resistance to lateral loads.
- 6.8.11 The recommendations presented above are generally applicable to the design of rigid concrete or masonry retaining walls having a maximum height of 12 feet. In the event that walls higher than 16 feet are planned, Geocon Incorporated should be consulted for additional recommendations.

6.9 Slope Maintenance

- 6.9.1 Slopes that are steeper than 3:1 (horizontal:vertical) may, under conditions which are both difficult to prevent and predict, be susceptible to near surface (surficial) slope instability. The instability is typically limited to the outer three feet of a portion of the slope and usually does not directly impact the improvements on the pad areas above or below the slope. The occurrence of surficial instability is more prevalent on fill slopes and is generally preceded by a period of heavy rainfall, excessive irrigation, or the migration of subsurface seepage. The disturbance and/or loosening of the surficial soils, as might result from root growth, soil expansion, or excavation for irrigation lines and slope planting, may also be a significant contributing factor to surficial instability. It is, therefore, recom-

mended that, to the maximum extent practical: (a) disturbed/loosened surficial soils be either removed or properly recompacted, (b) irrigation systems be periodically inspected and maintained to eliminate leaks and excessive irrigation, and (c) surface drains on and adjacent to slopes be periodically maintained to preclude ponding or erosion. It should be noted that although the incorporation of the above recommendations should reduce the potential for surficial slope instability, it will not eliminate the possibility, and, therefore, it may be necessary to rebuild or repair a portion of the project's slopes in the future.

6.10 Site Drainage and Moisture Protection

- 6.10.1 Adequate site drainage is critical to reduce the potential for differential soil movement, erosion and subsurface seepage. Under no circumstances should water be allowed to pond adjacent to footings. The site should be graded and maintained such that surface drainage is directed away from structures in accordance with 2016 CBC 1803.3 or other applicable standards. In addition, surface drainage should be directed away from the top of slopes into swales or other controlled drainage devices. Roof and pavement drainage should be directed into conduits that carry runoff away from the proposed structure.
- 6.10.2 In the case of basement walls or building walls retaining landscaping areas, a waterproofing system should be used on the wall and joints, and a Miradrain drainage panel (or similar) should be placed over the waterproofing. The project architect or civil engineer should provide detailed specifications on the plans for all waterproofing and drainage.
- 6.10.3 Underground utilities should be leak free. Utility and irrigation lines should be checked periodically for leaks, and detected leaks should be repaired promptly. Detrimental soil movement could occur if water is allowed to infiltrate the soil for prolonged periods of time.
- 6.10.4 Landscaping planters adjacent to paved areas are not recommended due to the potential for surface or irrigation water to infiltrate the pavement's subgrade and base course. We recommend that subdrains to collect excess irrigation water and transmit it to drainage structures, or impervious above-grade planter boxes be used. In addition, where landscaping is planned adjacent to the pavement, we recommend construction of a cutoff wall along the edge of the pavement that extends at least 6 inches below the bottom of the base material.

6.11 Plan Review

- 6.11.1 Geocon Incorporated should review the construction plans for the project prior to final design submittal to evaluate whether additional analyses and/or recommendations are required.

LIMITATIONS AND UNIFORMITY OF CONDITIONS

1. The firm that performed the geotechnical investigation for the project should be retained to provide testing and observation services during construction to provide continuity of geotechnical interpretation and to check that the recommendations presented for geotechnical aspects of site development are incorporated during site grading, construction of improvements, and excavation of foundations. If another geotechnical firm is selected to perform the testing and observation services during construction operations, that firm should prepare a letter indicating their intent to assume the responsibilities of project geotechnical engineer of record. A copy of the letter should be provided to the regulatory agency for their records. In addition, that firm should provide revised recommendations concerning the geotechnical aspects of the proposed development, or a written acknowledgement of their concurrence with the recommendations presented in our report. They should also perform additional analyses deemed necessary to assume the role of Geotechnical Engineer of Record.
2. The recommendations of this report pertain only to the site investigated and are based upon the assumption that the soil conditions do not deviate from those disclosed in the investigation. If any variations or undesirable conditions are encountered during construction, or if the proposed construction will differ from that anticipated herein, Geocon Incorporated should be notified so that supplemental recommendations can be given. The evaluation or identification of the potential presence of hazardous or corrosive materials was not part of the scope of services provided by Geocon Incorporated.
3. This report is issued with the understanding that it is the responsibility of the owner or his representative to ensure that the information and recommendations contained herein are brought to the attention of the architect and engineer for the project and incorporated into the plans, and the necessary steps are taken to see that the contractor and subcontractors carry out such recommendations in the field.
4. The findings of this report are valid as of the present date. However, changes in the conditions of a property can occur with the passage of time, whether they be due to natural processes or the works of man on this or adjacent properties. In addition, changes in applicable or appropriate standards may occur, whether they result from legislation or the broadening of knowledge. Accordingly, the findings of this report may be invalidated wholly or partially by changes outside our control. Therefore, this report is subject to review and should not be relied upon after a period of three years.

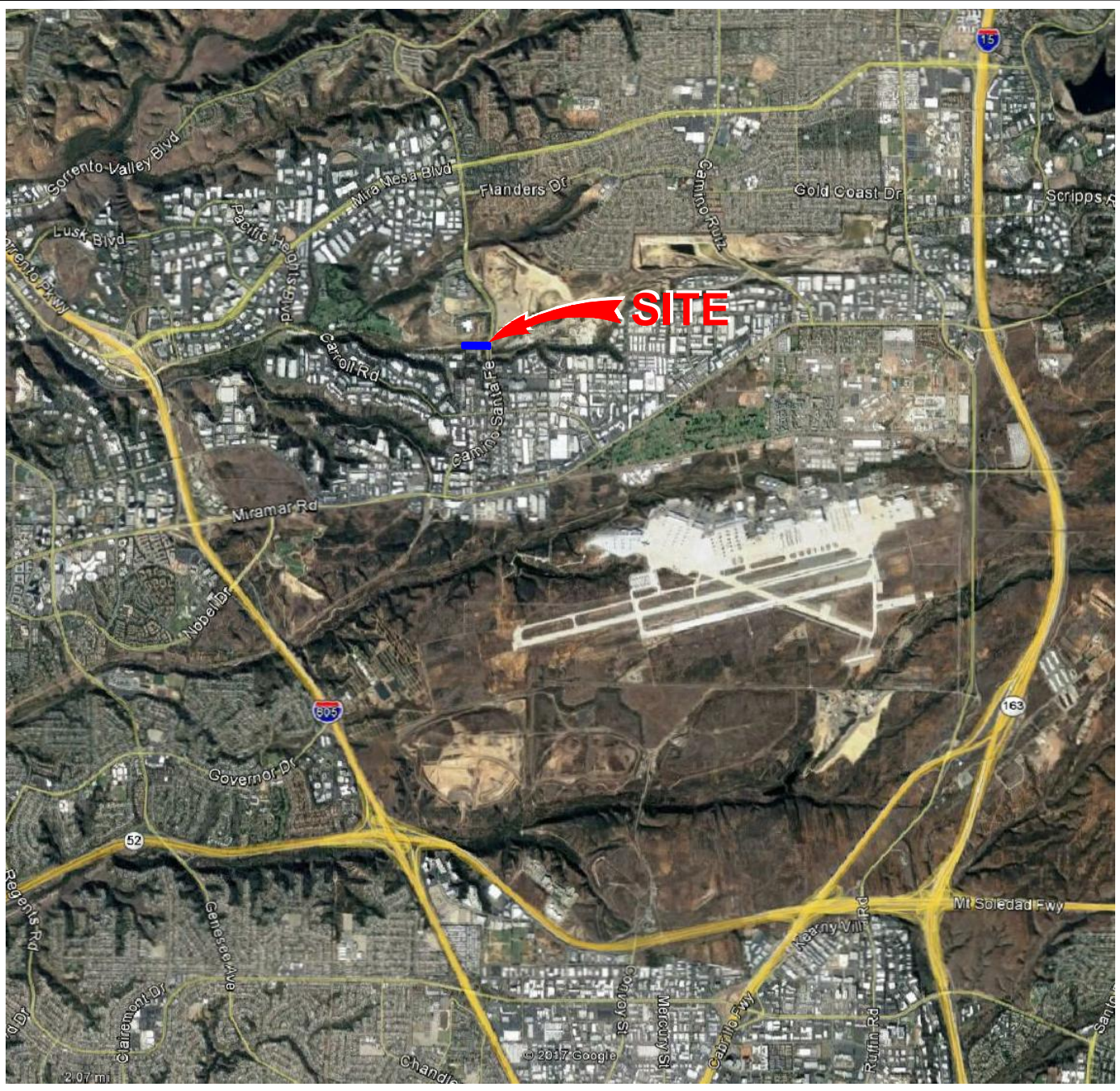

THE GEOGRAPHICAL INFORMATION MADE AVAILABLE FOR DISPLAY WAS PROVIDED BY GOOGLE EARTH, SUBJECT TO A LICENSING AGREEMENT. THE INFORMATION IS FOR ILLUSTRATIVE PURPOSES ONLY; IT IS NOT INTENDED FOR CLIENT'S USE OR RELIANCE AND SHALL NOT BE REPRODUCED BY CLIENT. CLIENT SHALL INDEMNIFY, DEFEND AND HOLD HARMLESS GEOCON FROM ANY LIABILITY INCURRED AS A RESULT OF SUCH USE OR RELIANCE BY CLIENT.



VICINITY MAP

GEOCON
INCORPORATED



GEOTECHNICAL ■ ENVIRONMENTAL ■ MATERIALS
6960 FLANDERS DRIVE - SAN DIEGO, CALIFORNIA 92121 - 2974
PHONE 858 558-6900 - FAX 858 558-6159

3ROOTS
CARROLL CANYON ROAD WEST
OFF-SITE IMPROVEMENTS
SAN DIEGO, CALIFORNIA

RM / AML	DSK/GTYPD	DATE 08 - 07 - 2018	PROJECT NO. G2070 - 42 - 02	FIG. 1
----------	-----------	---------------------	-----------------------------	--------

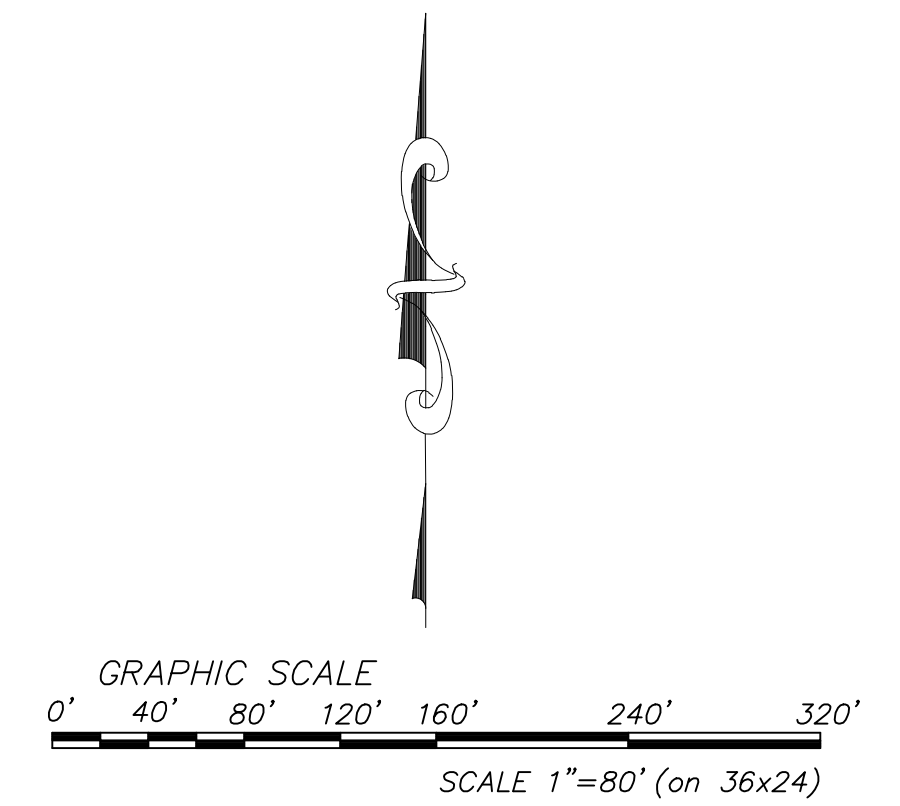
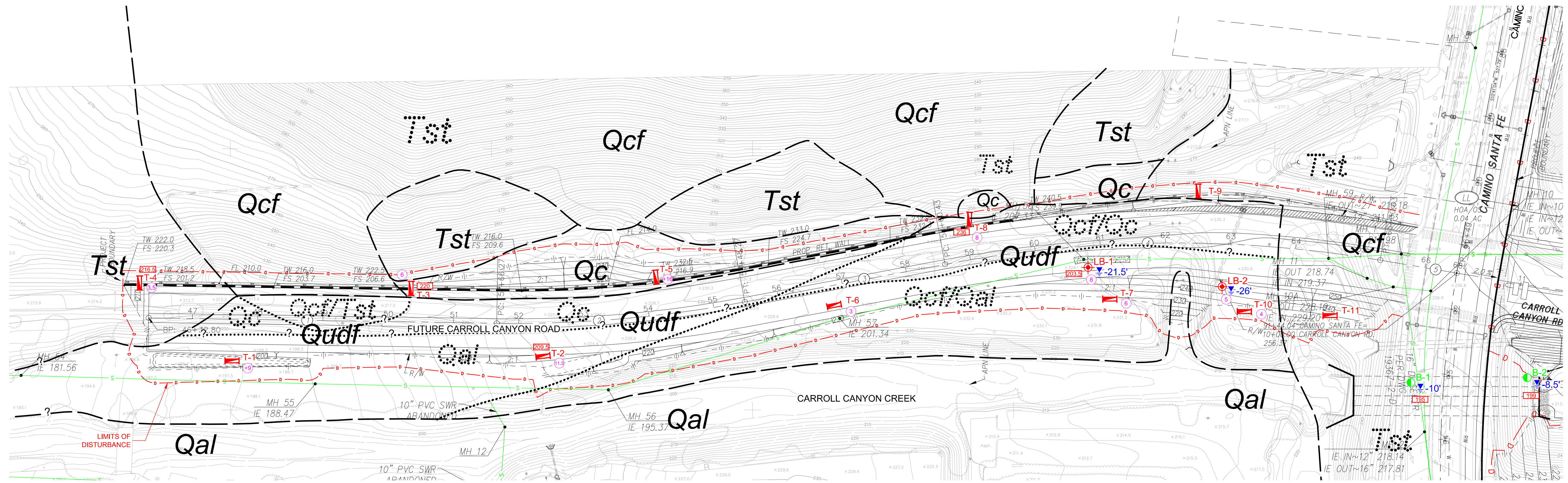

- GEOCON LEGEND**
- Qudf** UNDOCUMENTED FILL
 - Qcf** COMPACTED FILL (Dotted Where Buried)
 - Qal** ALLUVIUM (Dotted Where Buried)
 - Qc** COLLUVIUM (Dotted Where Buried)
 - Tst** STADIUM CONGLOMERATE (Dotted Where Buried)
 - APPROX. LOCATION OF GEOLOGIC CONTACT (Dotted Where Buried, Queried Where Uncertain)
 - LB-2** APPROX. LOCATION OF LARGE DIAMETER BORING
 - B-2** APPROX. LOCATION OF PREVIOUS SMALL DIAMETER BORING (Performed in June 2001 Prior to Grading of Camino Santa Fe)
 - T-11** APPROX. LOCATION OF EXPLORATORY TRENCH
 - ▼-12'** APPROX. DEPTH TO SEEPAGE/GROUNDWATER (In Feet)
 - ①** APPROX. THICKNESS OF REMEDIAL GRADING (In Feet)
 - 210'** APPROX. ELEVATION OF CONTACT WITH STADIUM CONGLOMERATE (In Feet)

GEOLOGIC MAP		
3ROOTS		
CARROLL CANYON ROAD WEST, OFF-SITE IMPROVEMENTS		
SAN DIEGO, CALIFORNIA		
GEOCON INCORPORATED	SCALE 1" = 80'	DATE 08 - 07 - 2018
GEO TECHNICAL ■ ENVIRONMENTAL ■ MATERIALS 6960 FLANDERS DRIVE - SAN DIEGO, CALIFORNIA 92121 - 2974 PHONE 619 558 6900 - FAX 619 558 6159	PROJECT NO. G2070 - 42 - 02	FIGURE 2
SHEET 1 OF 1		

Plotted: 08/07/2018 8:48AM | By: ALVIN LADRILLON | File Location: Y:\PROJECTS\G2070-42-02 (08/07/2018)\SHEETS\G2070-42-02 Geo Map (08/07/2018).dwg

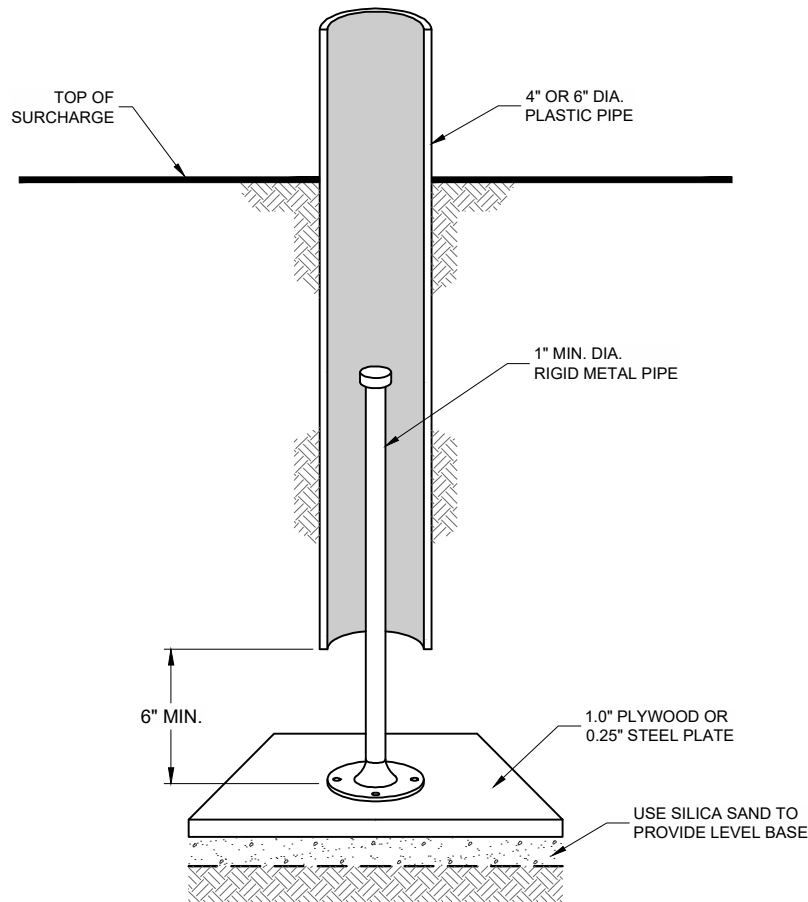

NOTES:

- 1.....LOCATION OF SETTLEMENT PLATES SHALL BE CLEARLY MARKED AND READILY VISIBLE (RED FLAG) TO EQUIPMENT OPERATORS.
- 2.....CONTRACTOR SHALL MAINTAIN 10-FOOT HORIZONTAL CLEARANCE FOR HEAVY EQUIPMENT WITHIN 5 FEET (VERTICAL) OF PLATE BASE. FILL WITHIN CLEARANCE AREA SHALL BE HAND COMPACTED TO PROJECT SPECIFICATIONS OR COMPACTED BY ALTERNATIVE APPROVED SOILS ENGINEER.
- 3.....AFTER 5 FEET (VERTICAL) OF FILL IS IN PLACE, THE CONTRACTOR SHALL MAINTAIN 5 FEET HORIZONTAL EQUIPMENT CLEARANCE. FILL IN CLEARANCE AREA SHALL BE HAND COMPACTED (OR APPROVED ALTERNATIVE) IN VERTICAL INCREMENTS NOT TO EXCEED 2 FEET.
- 4.....IN THE EVENT OF DAMAGE TO SETTLEMENT PLATE OR EXTENSION RESULTING FROM EQUIPMENT OPERATING WITHIN PRESCRIBED CLEARANCE AREA, CONTRACTORS SHALL IMMEDIATELY NOTIFY SOILS ENGINEER AND SHALL BE RESPONSIBLE FOR RESTORING THE SETTLEMENT PLATES TO WORKING ORDER.

NO SCALE

NO SCALE

SETTLEMENT MONUMENT DETAIL

GEOCON
INCORPORATED



GEOTECHNICAL ■ ENVIRONMENTAL ■ MATERIALS
6960 FLANDERS DRIVE - SAN DIEGO, CALIFORNIA 92121 - 2974
PHONE 858 558-6900 - FAX 858 558-6159

3ROOTS
CARROLL CANYON ROAD WEST
OFF-SITE IMPROVEMENTS
SAN DIEGO, CALIFORNIA

RM / AML

DSK/GTYPD

DATE 08 - 07 - 2018

PROJECT NO. G2070 - 42 - 02

FIG. 3

ASSUMED CONDITIONS :

SLOPE HEIGHT	H = 30 feet
SLOPE INCLINATION	2 : 1 (Horizontal : Vertical)
TOTAL UNIT WEIGHT OF SOIL	γ_t = 130 pounds per cubic foot
ANGLE OF INTERNAL FRICTION	ϕ = 35 degrees
APPARENT COHESION	C = 100 pounds per square foot
NO SEEPAGE FORCES	

ANALYSIS :

$\gamma_{c\phi}$ = $\frac{\gamma_t H \tan \phi}{C}$	EQUATION (3-3), REFERENCE 1
FS = $\frac{N_{cf} C}{\gamma_t H}$	EQUATION (3-2), REFERENCE 1
$\gamma_{c\phi}$ = 27	CALCULATED USING EQ. (3-3)
N_{cf} = 70	DETERMINED USING FIGURE 10, REFERENCE 2
FS = 1.79	FACTOR OF SAFETY CALCULATED USING EQ. (3-2)

REFERENCES :

- 1.....Janbu, N., Stability Analysis of Slopes with Dimensionless Parameters, Harvard Soil Mechanics, Series No. 46, 1954
- 2.....Janbu, N., Discussion of J.M. Bell, Dimensionless Parameters for Homogeneous Earth Slopes, Journal of Soil Mechanics and Foundation Design, No. SM6, November 1967.

SLOPE STABILITY ANALYSIS - CUT SLOPES

GEOCON
INCORPORATED



GEOTECHNICAL ■ ENVIRONMENTAL ■ MATERIALS
6960 FLANDERS DRIVE - SAN DIEGO, CALIFORNIA 92121 - 2974
PHONE 858 558-6900 - FAX 858 558-6159

3ROOTS
CARROLL CANYON ROAD WEST
OFF-SITE IMPROVEMENTS
SAN DIEGO, CALIFORNIA

RM / AML

DSK/GTYPD

DATE 08 - 07 - 2018

PROJECT NO. G2070 - 42 - 02

FIG. 4

ASSUMED CONDITIONS :

SLOPE HEIGHT	H = 40 feet
SLOPE INCLINATION	2 : 1 (Horizontal : Vertical)
TOTAL UNIT WEIGHT OF SOIL	$\gamma_t = 130$ pounds per cubic foot
ANGLE OF INTERNAL FRICTION	$\phi = 30$ degrees
APPARENT COHESION	C = 300 pounds per square foot
NO SEEPAGE FORCES	

ANALYSIS :

$\gamma_{c\phi} = \frac{\gamma_t H \tan \phi}{C}$	EQUATION (3-3), REFERENCE 1
$FS = \frac{N_{cf} C}{\gamma_t H}$	EQUATION (3-2), REFERENCE 1
$\gamma_{c\phi} = 10$	CALCULATED USING EQ. (3-3)
$N_{cf} = 33$	DETERMINED USING FIGURE 10, REFERENCE 2
$FS = 1.90$	FACTOR OF SAFETY CALCULATED USING EQ. (3-2)

REFERENCES :

- 1.....Janbu, N., Stability Analysis of Slopes with Dimensionless Parameters, Harvard Soil Mechanics, Series No. 46, 1954
- 2.....Janbu, N., Discussion of J.M. Bell, Dimensionless Parameters for Homogeneous Earth Slopes, Journal of Soil Mechanics and Foundation Design, No. SM6, November 1967.

SLOPE STABILITY ANALYSIS - FILL SLOPES

GEOCON
INCORPORATED



GEOTECHNICAL ■ ENVIRONMENTAL ■ MATERIALS
6960 FLANDERS DRIVE - SAN DIEGO, CALIFORNIA 92121 - 2974
PHONE 858 558-6900 - FAX 858 558-6159

3ROOTS
CARROLL CANYON ROAD WEST
OFF-SITE IMPROVEMENTS
SAN DIEGO, CALIFORNIA

RM / AML

DSK/GTYPD

DATE 08 - 07 - 2018

PROJECT NO. G2070 - 42 - 02

FIG. 5

ASSUMED CONDITIONS :

SLOPE HEIGHT	H = Infinite
DEPTH OF SATURATION	Z = 3 feet
SLOPE INCLINATION	2 : 1 (Horizontal : Vertical)
SLOPE ANGLE	i = 26.6 degrees
UNIT WEIGHT OF WATER	γ_w = 62.4 pounds per cubic foot
TOTAL UNIT WEIGHT OF SOIL	γ_t = 130 pounds per cubic foot
ANGLE OF INTERNAL FRICTION	ϕ = 30 degrees
APPARENT COHESION	C = 300 pounds per square foot

SLOPE SATURATED TO VERTICAL DEPTH Z BELOW SLOPE FACE

SEEPAGE FORCES PARALLEL TO SLOPE FACE

ANALYSIS :

$$FS = \frac{C + (\gamma_t - \gamma_w) Z \cos^2 i \tan \phi}{\gamma_t Z \sin i \cos i} = 2.5$$

REFERENCES :

- 1.....Haefeli, R. *The Stability of Slopes Acted Upon by Parallel Seepage*, Proc. Second International Conference, SMFE, Rotterdam, 1948, 1, 57-62
- 2.....Skempton, A. W., and F.A. Delory, *Stability of Natural Slopes in London Clay*, Proc. Fourth International Conference, SMFE, London, 1957, 2, 378-81

SURFICIAL SLOPE STABILITY ANALYSIS

GEOCON
INCORPORATED



GEOTECHNICAL ■ ENVIRONMENTAL ■ MATERIALS
6960 FLANDERS DRIVE - SAN DIEGO, CALIFORNIA 92121 - 2974
PHONE 858 558-6900 - FAX 858 558-6159

3ROOTS
CARROLL CANYON ROAD WEST
OFF-SITE IMPROVEMENTS
SAN DIEGO, CALIFORNIA

RM / AML

DSK/GTYPD

DATE 08 - 07 - 2018

PROJECT NO. G2070 - 42 - 02

FIG. 6

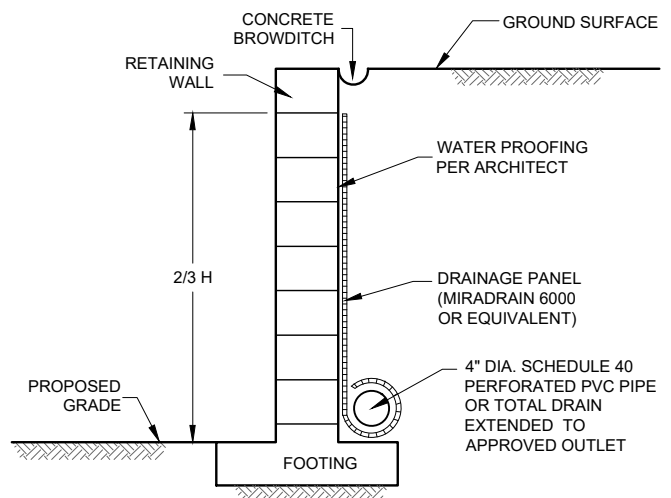
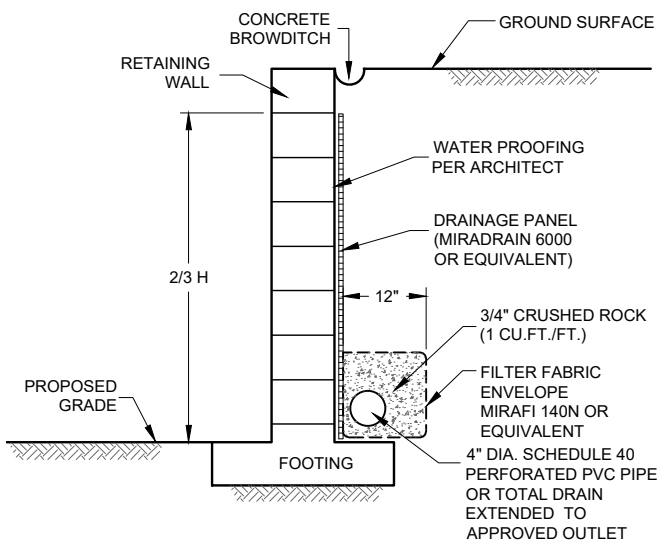
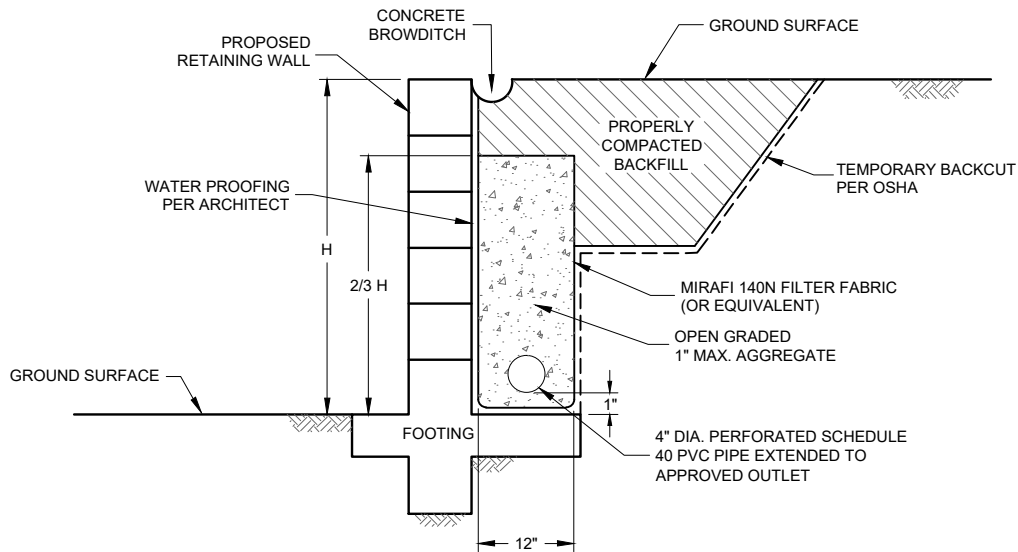

NOTE :

DRAIN SHOULD BE UNIFORMLY SLOPED TO GRAVITY OUTLET
OR TO A SUMP WHERE WATER CAN BE REMOVED BY PUMPING

NO SCALE

TYPICAL RETAINING WALL DRAIN DETAIL

GEOCON
INCORPORATED



GEOTECHNICAL ■ ENVIRONMENTAL ■ MATERIALS
6960 FLANDERS DRIVE - SAN DIEGO, CALIFORNIA 92121 - 2974
PHONE 858 558-6900 - FAX 858 558-6159

3ROOTS
CARROLL CANYON ROAD WEST
OFF-SITE IMPROVEMENTS
SAN DIEGO, CALIFORNIA

RM / AML

DSK/GTYPD

DATE 08 - 07 - 2018

PROJECT NO. G2070 - 42 - 02

FIG. 7

APPENDIX

A

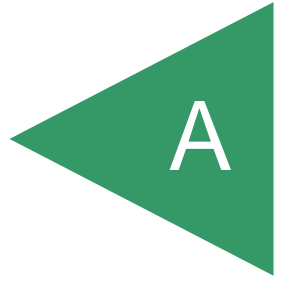

APPENDIX A

FIELD INVESTIGATION

Our field investigation was performed between July 13 and 16, 2018, and consisted of a site reconnaissance, and the excavation of two large-diameter borings and eleven exploratory trenches. The approximate locations of the exploratory borings and trenches are shown on the *Geologic Map*, Figure 2, including our previous small-diameter borings.

The two large-diameter borings (LB-1 and LB-2) were performed by Dave's Drilling and advanced to a maximum depth of 29 feet below existing grade using an EasyBore 120 truck-mounted drill rig equipped with a 30-inch-diameter bucket auger. Relatively undisturbed samples were obtained by driving a 3-inch, O.D., split-tube sampler into the "undisturbed" soil mass with the drill rig kelly bar. The sampler was equipped with 1-inch by 2 $\frac{3}{8}$ -inch brass sampler rings to facilitate removal and testing. Bulk samples were also obtained. The logs of the large-diameter borings depicting the soil and geologic conditions encountered and the depth at which samples were obtained are presented on Figures A-1 through A-2.

The exploratory trenches (T-1 through T-11) were advanced by Hillside Excavating to depths of 3 to 16 feet using a John Deere 410 rubber-tire backhoe equipped with a 24-inch-wide bucket. Bulk samples were also collected. Logs of the backhoe trenches depicting the soil and geologic conditions encountered are presented on Figures A-3 through A-13.

The previous small-diameter borings (B-1 and B-2) were performed as part of a separate study in June 2001 prior to grading Camino Santa Fe using a limited access rig. The original logs have been included after Figure A-13 for reference.

The soils encountered in the excavations were visually classified and logged in general accordance with American Society for Testing and Materials (ASTM) practice for Description and Identification of Soils (Visual Manual Procedure D 2488).

DEPTH IN FEET	SAMPLE NO.	LITHOLOGY	GROUNDWATER	SOIL CLASS (USCS)	BORING LB 1 ELEV. (MSL.) <u>228'</u> DATE COMPLETED <u>07-13-2018</u> EQUIPMENT <u>Bucket Rig</u> BY: <u>T. REIST</u>		PENETRATION RESISTANCE (BLOWS/FT.)	DRY DENSITY (P.C.F.)	MOISTURE CONTENT (%)		
MATERIAL DESCRIPTION											
0	LB1-1			SM	UNDOCUMENTED FILL (Qudf) Loose to medium dense, dry, Silty, fine to medium SAND with 10%-20% gravel and cobble size rock fragments up to 6-inches -Gravel and cobble content increases to 20%-30% below 4 feet -Becomes damp below 5 feet				5.3		
2											
4											
6											
8											
10	LB1-2					SM/SC	COMPACTED FILL (Qcf) Medium dense, moist, Silty/Clayey, fine to medium SAND with 10%-30% gravel and cobble size rock fragments up to 6-inches; auger used below 8 feet -Blow counts likely not accurate due to gravel				9.9
12	LB1-3							2	109.6	9.7	
14											
16	LB1-4				4	107.6		11.2			
18											
20	LB1-5				6						
22	LB1-6			SP	*Approx. elevation (el 207) of adjacent 24-inch trunk sewer main -Heavy seepage at 21.5 feet	6		121.5	10.7		
24					ALLUVIUM (Qal) Medium dense, wet, gray, fine to medium SAND with gravel pockets with 30%-40% gravel and cobble size rock fragments up to 3-inches; little to no cohesion; caving						
26	LB1-7			SM	STADIUM CONGLOMERATE (Tst) Dense, moist to very moist, gray and orange, Silty, fine to medium SANDSTONE	7	108.7	17.5			
					BORING TERMINATED AT 26 FEET Groundwater encountered at 21.5 feet Geotechnically logged to 22 feet due to caving						

Figure A-1,
Log of Boring LB 1, Page 1 of 1

G2070-42-02 (CCR WEST).GPJ







SAMPLE SYMBOLS		... SAMPLING UNSUCCESSFUL		... STANDARD PENETRATION TEST		... DRIVE SAMPLE (UNDISTURBED)
		... DISTURBED OR BAG SAMPLE		... CHUNK SAMPLE		... WATER TABLE OR SEEPAGE

NOTE: THE LOG OF SUBSURFACE CONDITIONS SHOWN HEREON APPLIES ONLY AT THE SPECIFIC BORING OR TRENCH LOCATION AND AT THE DATE INDICATED. IT IS NOT WARRANTED TO BE REPRESENTATIVE OF SUBSURFACE CONDITIONS AT OTHER LOCATIONS AND TIMES.

DEPTH IN FEET	SAMPLE NO.	LITHOLOGY	GROUNDWATER	SOIL CLASS (USCS)	BORING LB 2		PENETRATION RESISTANCE (BLOWS/FT.)	DRY DENSITY (P.C.F.)	MOISTURE CONTENT (%)
					ELEV. (MSL.) 232	DATE COMPLETED 07-13-2018			
					EQUIPMENT Bucket Rig		BY: T. REIST		
MATERIAL DESCRIPTION									
0				SM	UNDOCUMENTED FILL (Qudf) Loose to medium dense, damp, Silty, fine to medium SAND with 10%-15% gravel and cobble size rock fragments up to 10-inches				
2									
4									
6	LB2-1			SM/SC	COMPACTED FILL (Qcf) Medium dense, moist, Silty/Clayey, fine to medium SAND with 10%-30% gravel and cobble size rock fragments up to 6-inches		3	117.3	9.1
8									
10	LB2-2						2	113.1	14.8
12					-Trace boulders up to 14-inches present below 12 feet				
14									
16					-No recovery		2		
18				SP	ALLUVIUM (Qal) Medium dense, damp, light brown to dark brown, fine to medium SAND with gravel pockets with 30%-40% gravel and cobble size rock fragments up to 10-inches; little to no cohesion; caving; boring belled out 8 feet below 16 feet				
20	LB2-3				-Blow counts not accurate due to gravel		8	119.4	6.1
22									
24					*Approx. elevation (el 208) of adjacent 24-inch trunk sewer main				
26	LB2-4				-Sample disturbed -Heavy seepage at 26 feet		3		
28									
					-Possible Stadium Conglomerate contact at 29 feet				
					BORING TERMINATED AT 29 FEET DUE TO CAVING Groundwater encountered at 21 feet Geotechnically logged to 16 feet due to caving				

Figure A-2,
Log of Boring LB 2, Page 1 of 1

G2070-42-02 (CCR WEST).GPJ

SAMPLE SYMBOLS		... SAMPLING UNSUCCESSFUL		... STANDARD PENETRATION TEST		... DRIVE SAMPLE (UNDISTURBED)
		... DISTURBED OR BAG SAMPLE		... CHUNK SAMPLE		... WATER TABLE OR SEEPAGE

NOTE: THE LOG OF SUBSURFACE CONDITIONS SHOWN HEREON APPLIES ONLY AT THE SPECIFIC BORING OR TRENCH LOCATION AND AT THE DATE INDICATED. IT IS NOT WARRANTED TO BE REPRESENTATIVE OF SUBSURFACE CONDITIONS AT OTHER LOCATIONS AND TIMES.







DEPTH IN FEET	SAMPLE NO.	LITHOLOGY	GROUNDWATER	SOIL CLASS (USCS)	TRENCH T 1		PENETRATION RESISTANCE (BLOWS/FT.)	DRY DENSITY (P.C.F.)	MOISTURE CONTENT (%)
					ELEV. (MSL.) <u>198'</u>	DATE COMPLETED <u>07-16-2018</u>			
					EQUIPMENT <u>Rubber Tire Backhoe</u> BY: <u>T. REIST</u>				
MATERIAL DESCRIPTION									
0				SM&SC	UNDOCUMENTED FILL (Qudf) Loose, damp, brown, Silty and Clayey, fine to medium SAND with 10%-15% gravel and cobble size rock fragments up to 6-inches with some trace asphalt chunks				
2				SM	ALLUVIUM (Qal) Loose to medium, dense, damp to moist, brown, Silty, fine to medium SAND				
4				SP	Loose to medium dense, damp, fine to medium SAND with 10%-30% gravel and cobble size rock fragments up to 4-inches; little to no cohesion; caving				
6									
8									
					TRENCH TERMINATED AT 9 FEET DUE TO CAVING Groundwater not encountered				

Figure A-3,
Log of Trench T 1, Page 1 of 1

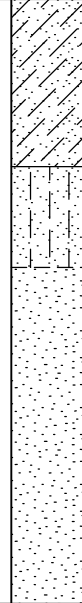
G2070-42-02 (CCR WEST).GPJ

SAMPLE SYMBOLS	 ... SAMPLING UNSUCCESSFUL	 ... STANDARD PENETRATION TEST	 ... DRIVE SAMPLE (UNDISTURBED)
	 ... DISTURBED OR BAG SAMPLE	 ... CHUNK SAMPLE	 ... WATER TABLE OR SEEPAGE

NOTE: THE LOG OF SUBSURFACE CONDITIONS SHOWN HEREON APPLIES ONLY AT THE SPECIFIC BORING OR TRENCH LOCATION AND AT THE DATE INDICATED. IT IS NOT WARRANTED TO BE REPRESENTATIVE OF SUBSURFACE CONDITIONS AT OTHER LOCATIONS AND TIMES.

DEPTH IN FEET	SAMPLE NO.	LITHOLOGY	GROUNDWATER	SOIL CLASS (USCS)	TRENCH T 2		PENETRATION RESISTANCE (BLOWS/FT.)	DRY DENSITY (P.C.F.)	MOISTURE CONTENT (%)
					ELEV. (MSL.) <u>221'</u>	DATE COMPLETED <u>07-16-2018</u>			
					EQUIPMENT <u>Rubber Tire Backhoe</u>		BY: <u>T. REIST</u>		
MATERIAL DESCRIPTION									
0				SM	UNDOCUMENTED FILL (Qudf) Loose, damp, brown, Gravelly, fine to medium SAND with 30%-40% gravel, cobble and boulder size rock fragments up to 14-inches				
2			SM	ALLUVIUM (Qal) Loose to medium dense, damp, dark brown, Silty, fine to medium SAND with 10%-30% gravel and cobble size rock fragments up to 10-inches -Little to no gravel and cobble below 6 feet					
4			SM	STADIUM CONGLOMERATE (Tst) Dense, damp, gray and orange, Silty, fine to medium SANDSTONE -Gravel and cobble present at bottom of trench					
6					TRENCH TERMINATED AT 13 FEET Groundwater not encountered				
8									
10									
12									

Figure A-4,
Log of Trench T 2, Page 1 of 1

G2070-42-02 (CCR WEST).GPJ

SAMPLE SYMBOLS	... SAMPLING UNSUCCESSFUL	... STANDARD PENETRATION TEST	... DRIVE SAMPLE (UNDISTURBED)
	... DISTURBED OR BAG SAMPLE	... CHUNK SAMPLE	... WATER TABLE OR SEEPAGE

NOTE: THE LOG OF SUBSURFACE CONDITIONS SHOWN HEREON APPLIES ONLY AT THE SPECIFIC BORING OR TRENCH LOCATION AND AT THE DATE INDICATED. IT IS NOT WARRANTED TO BE REPRESENTATIVE OF SUBSURFACE CONDITIONS AT OTHER LOCATIONS AND TIMES.

DEPTH IN FEET	SAMPLE NO.	LITHOLOGY	GROUNDWATER	SOIL CLASS (USCS)	TRENCH T 3		PENETRATION RESISTANCE (BLOWS/FT.)	DRY DENSITY (P.C.F.)	MOISTURE CONTENT (%)
					ELEV. (MSL.) <u>226'</u>	DATE COMPLETED <u>07-16-2018</u>			
					EQUIPMENT <u>Rubber Tire Backhoe</u>		BY: <u>T. REIST</u>		
MATERIAL DESCRIPTION									
0				SM/SC	COLLUVIUM (Qc) Medium dense, damp to moist, dark brown, Gravelly/Clayey, fine to coarse SAND with 30%-40% gravel and cobble size rock fragments up to 8-inches				
2									
4									
6				GM	STADIUM CONGLOMERATE (Tst) Dense, damp, gray, fine to medium, Sandy CONGLOMERATE with 50%-70% gravel and cobble size rock fragments up to 10-inches				
8									
10					TRENCH TERMINATED AT 10 FEET Groundwater not encountered				

Figure A-5,
Log of Trench T 3, Page 1 of 1

G2070-42-02 (CCR WEST).GPJ

SAMPLE SYMBOLS	... SAMPLING UNSUCCESSFUL	... STANDARD PENETRATION TEST	... DRIVE SAMPLE (UNDISTURBED)
	... DISTURBED OR BAG SAMPLE	... CHUNK SAMPLE	... WATER TABLE OR SEEPAGE

NOTE: THE LOG OF SUBSURFACE CONDITIONS SHOWN HEREON APPLIES ONLY AT THE SPECIFIC BORING OR TRENCH LOCATION AND AT THE DATE INDICATED. IT IS NOT WARRANTED TO BE REPRESENTATIVE OF SUBSURFACE CONDITIONS AT OTHER LOCATIONS AND TIMES.

DEPTH IN FEET	SAMPLE NO.	LITHOLOGY	GROUNDWATER	SOIL CLASS (USCS)	TRENCH T 4		PENETRATION RESISTANCE (BLOWS/FT.)	DRY DENSITY (P.C.F.)	MOISTURE CONTENT (%)
					ELEV. (MSL.) <u>220'</u>	DATE COMPLETED <u>07-16-2018</u>			
					EQUIPMENT <u>Rubber Tire Backhoe</u>		BY: <u>T. REIST</u>		
MATERIAL DESCRIPTION									
0				SM	TOPSOIL Loose to medium dense, dry, brown, Gravelly, fine to coarse SAND with 30%-40% gravel and cobble size rock fragments up to 6-inches				
2									
4				SM	STADIUM CONGLOMERATE (Tst) Dense, damp, gray and orange, Gravelly, fine to medium SAND with 30%-50% gravel and cobble size rock fragments up to 6-inches				
6						TRENCH TERMINATED AT 6 FEET Groundwater not encountered			

Figure A-6,
Log of Trench T 4, Page 1 of 1

G2070-42-02 (CCR WEST).GPJ

SAMPLE SYMBOLS	... SAMPLING UNSUCCESSFUL	... STANDARD PENETRATION TEST	... DRIVE SAMPLE (UNDISTURBED)
	... DISTURBED OR BAG SAMPLE	... CHUNK SAMPLE	... WATER TABLE OR SEEPAGE

NOTE: THE LOG OF SUBSURFACE CONDITIONS SHOWN HEREON APPLIES ONLY AT THE SPECIFIC BORING OR TRENCH LOCATION AND AT THE DATE INDICATED. IT IS NOT WARRANTED TO BE REPRESENTATIVE OF SUBSURFACE CONDITIONS AT OTHER LOCATIONS AND TIMES.

DEPTH IN FEET	SAMPLE NO.	LITHOLOGY	GROUNDWATER	SOIL CLASS (USCS)	TRENCH T 5		PENETRATION RESISTANCE (BLOWS/FT.)	DRY DENSITY (P.C.F.)	MOISTURE CONTENT (%)	
					ELEV. (MSL.) <u>233'</u>	DATE COMPLETED <u>07-16-2018</u>				
					EQUIPMENT <u>Rubber Tire Backhoe</u>		BY: <u>T. REIST</u>			
MATERIAL DESCRIPTION										
0				GM	COLLUVIUM (Qc) Medium dense, damp, dark brown, fine to medium, Sandy GRAVEL with 50%-60% gravel and cobble size rock fragments up to 6-inches					
2										
4										
6	T5-1									
8										
10										
12					SM	Medium dense, damp, dark brown, Silty, fine to medium SAND				
14						-Some gravel and cobble size rock fragments up to 6-inches present below 14 feet				
16						TRENCH TERMINATED AT 16 FEET Groundwater not encountered				

Figure A-7,
Log of Trench T 5, Page 1 of 1

G2070-42-02 (CCR WEST).GPJ

SAMPLE SYMBOLS	... SAMPLING UNSUCCESSFUL	... STANDARD PENETRATION TEST	... DRIVE SAMPLE (UNDISTURBED)
	... DISTURBED OR BAG SAMPLE	... CHUNK SAMPLE	... WATER TABLE OR SEEPAGE

NOTE: THE LOG OF SUBSURFACE CONDITIONS SHOWN HEREON APPLIES ONLY AT THE SPECIFIC BORING OR TRENCH LOCATION AND AT THE DATE INDICATED. IT IS NOT WARRANTED TO BE REPRESENTATIVE OF SUBSURFACE CONDITIONS AT OTHER LOCATIONS AND TIMES.

DEPTH IN FEET	SAMPLE NO.	LITHOLOGY	GROUNDWATER	SOIL CLASS (USCS)	TRENCH T 7		PENETRATION RESISTANCE (BLOWS/FT.)	DRY DENSITY (P.C.F.)	MOISTURE CONTENT (%)
					ELEV. (MSL.) <u>231'</u>	DATE COMPLETED <u>07-16-2018</u>			
					EQUIPMENT <u>Rubber Tire Backhoe</u>		BY: <u>T. REIST</u>		
MATERIAL DESCRIPTION									
0				SM	UNDOCUMENTED FILL (Qudf) Loose to medium dense, dry to damp, brown, Gravelly, fine to medium SAND with 30%-40% gravel and cobble size rock fragments up to 8-inches				
2									
4									
6				SM	COMPACTED FILL (Qcf) Medium dense, damp to moist, Gravelly, fine to medium SAND with 30%-40% gravel and cobble size rock fragments up to 10-inches				
8									
10									
12						TRENCH TERMINATED AT 12 FEET Groundwater not encountered			

Figure A-9,
Log of Trench T 7, Page 1 of 1

G2070-42-02 (CCR WEST).GPJ

SAMPLE SYMBOLS	... SAMPLING UNSUCCESSFUL	... STANDARD PENETRATION TEST	... DRIVE SAMPLE (UNDISTURBED)
	... DISTURBED OR BAG SAMPLE	... CHUNK SAMPLE	... WATER TABLE OR SEEPAGE

NOTE: THE LOG OF SUBSURFACE CONDITIONS SHOWN HEREON APPLIES ONLY AT THE SPECIFIC BORING OR TRENCH LOCATION AND AT THE DATE INDICATED. IT IS NOT WARRANTED TO BE REPRESENTATIVE OF SUBSURFACE CONDITIONS AT OTHER LOCATIONS AND TIMES.

DEPTH IN FEET	SAMPLE NO.	LITHOLOGY	GROUNDWATER	SOIL CLASS (USCS)	TRENCH T 8		PENETRATION RESISTANCE (BLOWS/FT.)	DRY DENSITY (P.C.F.)	MOISTURE CONTENT (%)
					ELEV. (MSL.) <u>244'</u>	DATE COMPLETED <u>07-16-2018</u>			
					EQUIPMENT <u>Rubber Tire Backhoe</u>		BY: <u>T. REIST</u>		
MATERIAL DESCRIPTION									
0				SM&SC	COLLUVIUM (Qc) Medium dense, damp, dark brown, Gravelly and Clayey, fine to medium SAND with 30%-40% gravel and cobble size rock fragments up to 6-inches				
2									
4									
6									
8				GM	STADIUM CONGLOMERATE (Tst) Dense, damp, light brown, fine to medium, Sandy CONGLOMERATE with 50%-60% gravel and cobble size rock fragments up to 10-inches				
10									
					TRENCH TERMINATED AT 10 FEET Groundwater not encountered				

Figure A-10,
Log of Trench T 8, Page 1 of 1

G2070-42-02 (CCR WEST).GPJ

SAMPLE SYMBOLS	... SAMPLING UNSUCCESSFUL	... STANDARD PENETRATION TEST	... DRIVE SAMPLE (UNDISTURBED)
	... DISTURBED OR BAG SAMPLE	... CHUNK SAMPLE	... WATER TABLE OR SEEPAGE

NOTE: THE LOG OF SUBSURFACE CONDITIONS SHOWN HEREON APPLIES ONLY AT THE SPECIFIC BORING OR TRENCH LOCATION AND AT THE DATE INDICATED. IT IS NOT WARRANTED TO BE REPRESENTATIVE OF SUBSURFACE CONDITIONS AT OTHER LOCATIONS AND TIMES.







DEPTH IN FEET	SAMPLE NO.	LITHOLOGY	GROUNDWATER	SOIL CLASS (USCS)	TRENCH T 9		PENETRATION RESISTANCE (BLOWS/FT.)	DRY DENSITY (P.C.F.)	MOISTURE CONTENT (%)
					ELEV. (MSL.) <u>245'</u>	DATE COMPLETED <u>07-16-2018</u>			
					EQUIPMENT <u>Rubber Tire Backhoe</u> BY: <u>T. REIST</u>				
MATERIAL DESCRIPTION									
0				GM	COMPACTED FILL (Qcf) Medium dense, damp, brown, fine to medium, Sandy GRAVEL with 40%-60% gravel and cobble size rock fragments up to 6-inches				
2									
					TRENCH TERMINATED AT 3 FEET Groundwater not encountered				

Figure A-11,
Log of Trench T 9, Page 1 of 1

G2070-42-02 (CCR WEST).GPJ

SAMPLE SYMBOLS		... SAMPLING UNSUCCESSFUL		... STANDARD PENETRATION TEST		... DRIVE SAMPLE (UNDISTURBED)
		... DISTURBED OR BAG SAMPLE		... CHUNK SAMPLE		... WATER TABLE OR SEEPAGE

NOTE: THE LOG OF SUBSURFACE CONDITIONS SHOWN HEREON APPLIES ONLY AT THE SPECIFIC BORING OR TRENCH LOCATION AND AT THE DATE INDICATED. IT IS NOT WARRANTED TO BE REPRESENTATIVE OF SUBSURFACE CONDITIONS AT OTHER LOCATIONS AND TIMES.

DEPTH IN FEET	SAMPLE NO.	LITHOLOGY	GROUNDWATER	SOIL CLASS (USCS)	TRENCH T 10		PENETRATION RESISTANCE (BLOWS/FT.)	DRY DENSITY (P.C.F.)	MOISTURE CONTENT (%)
					ELEV. (MSL.) <u>232'</u>	DATE COMPLETED <u>07-16-2018</u>			
					EQUIPMENT <u>Rubber Tire Backhoe</u>		BY: <u>T. REIST</u>		
MATERIAL DESCRIPTION									
0				SM	UNDOCUMENTED FILL FILL (Qudf) Loose to medium dense, damp, brown, Silty, fine to medium SAND with 10%-20% gravel and cobble size rock fragments up to 8-inches				
2									
4					COMPACTED FILL (Qcf) Medium dense, damp to moist, Silty, fine to medium SAND with 10%-15% gravel and cobble size rock fragments up to 8-inches				
6									
					TRENCH TERMINATED AT 7 FEET Groundwater not encountered				

Figure A-12,
Log of Trench T 10, Page 1 of 1

G2070-42-02 (CCR WEST).GPJ

SAMPLE SYMBOLS		... SAMPLING UNSUCCESSFUL		... STANDARD PENETRATION TEST		... DRIVE SAMPLE (UNDISTURBED)
		... DISTURBED OR BAG SAMPLE		... CHUNK SAMPLE		... WATER TABLE OR SEEPAGE

NOTE: THE LOG OF SUBSURFACE CONDITIONS SHOWN HEREON APPLIES ONLY AT THE SPECIFIC BORING OR TRENCH LOCATION AND AT THE DATE INDICATED. IT IS NOT WARRANTED TO BE REPRESENTATIVE OF SUBSURFACE CONDITIONS AT OTHER LOCATIONS AND TIMES.

DEPTH IN FEET	SAMPLE NO.	LITHOLOGY	GROUNDWATER	SOIL CLASS (USCS)	TRENCH T 11		PENETRATION RESISTANCE (BLOWS/FT.)	DRY DENSITY (P.C.F.)	MOISTURE CONTENT (%)
					ELEV. (MSL.) <u>231'</u>	DATE COMPLETED <u>07-16-2018</u>			
					EQUIPMENT <u>Rubber Tire Backhoe</u> BY: <u>T. REIST</u>				
MATERIAL DESCRIPTION									
0				SM	COMPACTED FILL (Qcf) Medium dense, damp, brown, Gravelly, fine to medium SAND with 30%-40% gravel and cobble size rock fragments up to 6-inches				
2							TRENCH TERMINATED AT 3 FEET Groundwater not encountered		

Figure A-13,
Log of Trench T 11, Page 1 of 1

G2070-42-02 (CCR WEST).GPJ

SAMPLE SYMBOLS	... SAMPLING UNSUCCESSFUL	... STANDARD PENETRATION TEST	... DRIVE SAMPLE (UNDISTURBED)
	... DISTURBED OR BAG SAMPLE	... CHUNK SAMPLE	... WATER TABLE OR SEEPAGE

NOTE: THE LOG OF SUBSURFACE CONDITIONS SHOWN HEREON APPLIES ONLY AT THE SPECIFIC BORING OR TRENCH LOCATION AND AT THE DATE INDICATED. IT IS NOT WARRANTED TO BE REPRESENTATIVE OF SUBSURFACE CONDITIONS AT OTHER LOCATIONS AND TIMES.

PROJECT NO. 06127-42-05

DEPTH IN FEET	SAMPLE NO.	LITHOLOGY	GROUNDWATER	SOIL CLASS (USCS)	BORING B 1		PENETRATION RESISTANCE (BLOWS/FT.)	DRY DENSITY (P.C.F.)	MOISTURE CONTENT (%)
					ELEV. (MSL.) <u>211</u>	DATE COMPLETED <u>6/18/01</u>			
					EQUIPMENT <u>MOLE RIG</u>				
MATERIAL DESCRIPTION									
0									
2									
4	B1-1			SP			25		
6									
8									
10	B1-2						36		
12									
14									
					-Disturbed sample, saturated with trace silt				
					-Very dense at 15 feet, auger refusal on cobble (possible Stadium Conglomerate?)				
					BORING TERMINATED AT 15.5 FEET				

Log of Boring B 1

CSFB

SAMPLE SYMBOLS	... SAMPLING UNSUCCESSFUL	... STANDARD PENETRATION TEST	... DRIVE SAMPLE (UNDISTURBED)
	... DISTURBED OR BAG SAMPLE	... CHUNK SAMPLE	... WATER TABLE OR SEEPAGE

NOTE: THE LOG OF SUBSURFACE CONDITIONS SHOWN HEREON APPLIES ONLY AT THE SPECIFIC BORING OR TRENCH LOCATION AND AT THE DATE INDICATED. IT IS NOT WARRANTED TO BE REPRESENTATIVE OF SUBSURFACE CONDITIONS AT OTHER LOCATIONS AND TIMES.

PROJECT NO. 06127-42-05

DEPTH IN FEET	SAMPLE NO.	LITHOLOGY	GROUNDWATER	SOIL CLASS (USCS)	BORING B 2		PENETRATION RESISTANCE (BLOWS/FT.)	DRY DENSITY (P.C.F.)	MOISTURE CONTENT (%)
					ELEV. (MSL.) 213	DATE COMPLETED 6/18/01			
					EQUIPMENT MOLE RIG				
MATERIAL DESCRIPTION									
0									
2									
4	B2-1			SP			46		
6									
8									
10	B2-2						31		
12	B2-3						69		
14									
					-No recovery -Disturbed sample, pounded on rock				
					-Very dense at 14 feet, auger refusal on cobble (Possible stadium conglomerate)				
					BORING TERMINATED AT 14.5 FEET REFUSAL				

Log of Boring B 2

CSFB

SAMPLE SYMBOLS	... SAMPLING UNSUCCESSFUL	... STANDARD PENETRATION TEST	... DRIVE SAMPLE (UNDISTURBED)
	... DISTURBED OR BAG SAMPLE	... CHUNK SAMPLE	... WATER TABLE OR SEEPAGE

NOTE: THE LOG OF SUBSURFACE CONDITIONS SHOWN HEREON APPLIES ONLY AT THE SPECIFIC BORING OR TRENCH LOCATION AND AT THE DATE INDICATED. IT IS NOT WARRANTED TO BE REPRESENTATIVE OF SUBSURFACE CONDITIONS AT OTHER LOCATIONS AND TIMES.

APPENDIX

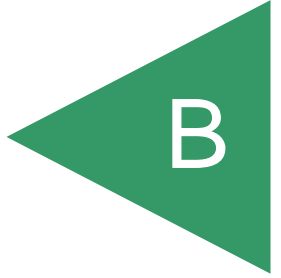

APPENDIX B

LABORATORY TESTING

We performed laboratory tests in accordance with generally accepted test methods of the American Society for Testing and Materials (ASTM) or other suggested procedures. We tested selected samples for in-place dry density and moisture content, Resistance Value (R-value) testing and consolidation characteristics. The results of our laboratory tests are presented in the following table and graph. The in-place dry density and moisture content test results are presented on the exploratory boring logs in Appendix A.

**TABLE B-1
SUMMARY OF LABORATORY RESISTANCE VALUE (R-VALUE) TEST RESULTS**

Sample No.	R-Value
T5-1	22

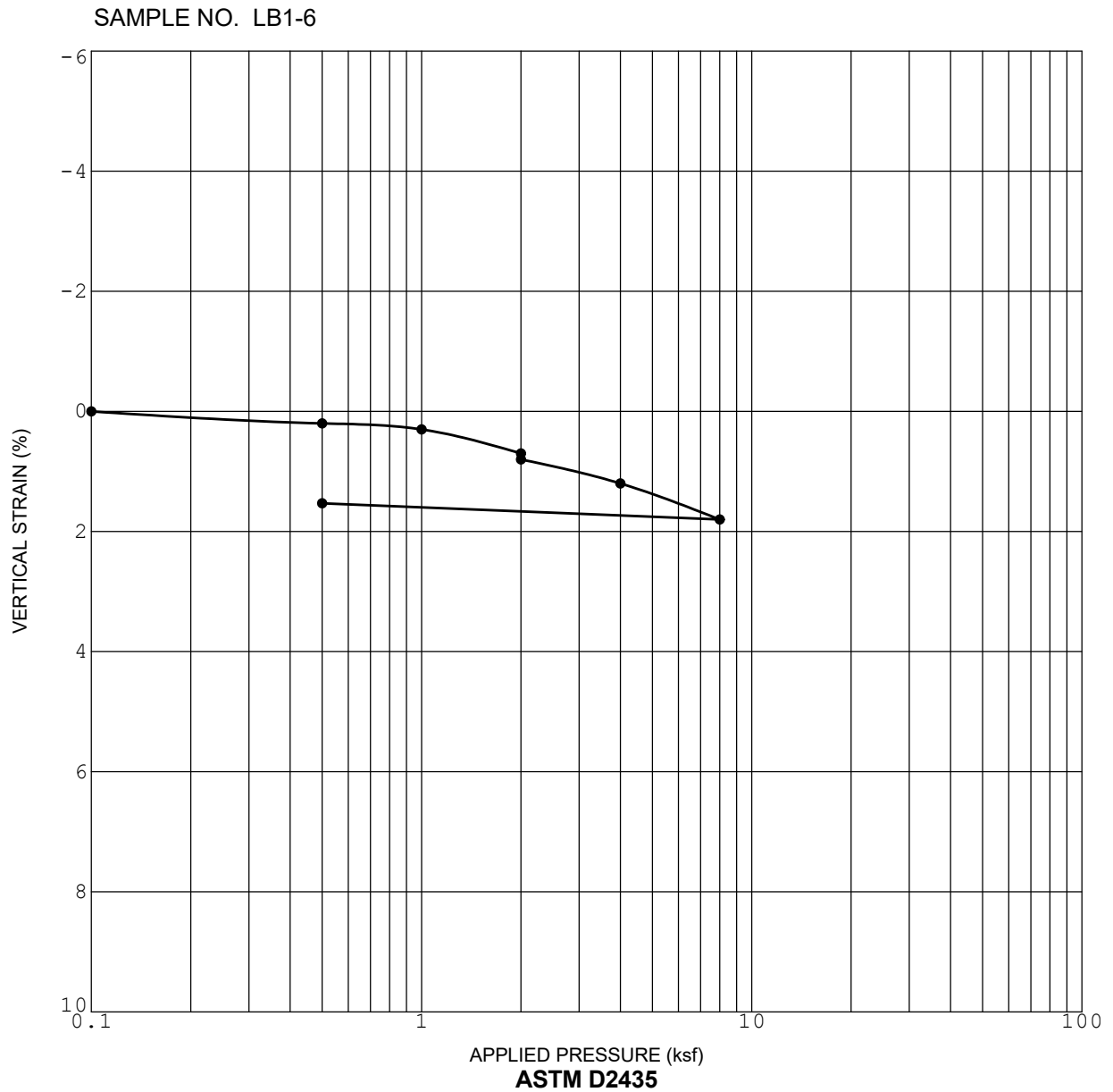

Initial Dry Density (pcf)	121.5
Initial Water Content (%)	10.7

Initial Saturation (%)	77.9
Sample Saturated at (ksf)	2.0

CONSOLIDATION CURVE

3ROOTS
CARROLL CANYON ROAD WEST, OFFSITE-IMPROVEMENTS
SAN DIEGO, CALIFORNIA

APPENDIX

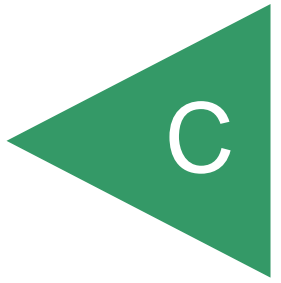

APPENDIX C

RECOMMENDED GRADING SPECIFICATIONS

FOR

3ROOTS
CARROLL CANYON ROAD WEST
OFF-SITE IMPROVEMENTS
SAN DIEGO, CALIFORNIA

PROJECT NO. G2070-42-02

RECOMMENDED GRADING SPECIFICATIONS

1. GENERAL

- 1.1 These Recommended Grading Specifications shall be used in conjunction with the Geotechnical Report for the project prepared by Geocon. The recommendations contained in the text of the Geotechnical Report are a part of the earthwork and grading specifications and shall supersede the provisions contained hereinafter in the case of conflict.
- 1.2 Prior to the commencement of grading, a geotechnical consultant (Consultant) shall be employed for the purpose of observing earthwork procedures and testing the fills for substantial conformance with the recommendations of the Geotechnical Report and these specifications. The Consultant should provide adequate testing and observation services so that they may assess whether, in their opinion, the work was performed in substantial conformance with these specifications. It shall be the responsibility of the Contractor to assist the Consultant and keep them apprised of work schedules and changes so that personnel may be scheduled accordingly.
- 1.3 It shall be the sole responsibility of the Contractor to provide adequate equipment and methods to accomplish the work in accordance with applicable grading codes or agency ordinances, these specifications and the approved grading plans. If, in the opinion of the Consultant, unsatisfactory conditions such as questionable soil materials, poor moisture condition, inadequate compaction, and/or adverse weather result in a quality of work not in conformance with these specifications, the Consultant will be empowered to reject the work and recommend to the Owner that grading be stopped until the unacceptable conditions are corrected.

2. DEFINITIONS

- 2.1 **Owner** shall refer to the owner of the property or the entity on whose behalf the grading work is being performed and who has contracted with the Contractor to have grading performed.
- 2.2 **Contractor** shall refer to the Contractor performing the site grading work.
- 2.3 **Civil Engineer** or **Engineer of Work** shall refer to the California licensed Civil Engineer or consulting firm responsible for preparation of the grading plans, surveying and verifying as-graded topography.
- 2.4 **Consultant** shall refer to the soil engineering and engineering geology consulting firm retained to provide geotechnical services for the project.

- 2.5 **Soil Engineer** shall refer to a California licensed Civil Engineer retained by the Owner, who is experienced in the practice of geotechnical engineering. The Soil Engineer shall be responsible for having qualified representatives on-site to observe and test the Contractor's work for conformance with these specifications.
- 2.6 **Engineering Geologist** shall refer to a California licensed Engineering Geologist retained by the Owner to provide geologic observations and recommendations during the site grading.
- 2.7 **Geotechnical Report** shall refer to a soil report (including all addenda) which may include a geologic reconnaissance or geologic investigation that was prepared specifically for the development of the project for which these Recommended Grading Specifications are intended to apply.

3. MATERIALS

- 3.1 Materials for compacted fill shall consist of any soil excavated from the cut areas or imported to the site that, in the opinion of the Consultant, is suitable for use in construction of fills. In general, fill materials can be classified as *soil* fills, *soil-rock* fills or *rock* fills, as defined below.
- 3.1.1 **Soil fills** are defined as fills containing no rocks or hard lumps greater than 12 inches in maximum dimension and containing at least 40 percent by weight of material smaller than $\frac{3}{4}$ inch in size.
- 3.1.2 **Soil-rock fills** are defined as fills containing no rocks or hard lumps larger than 4 feet in maximum dimension and containing a sufficient matrix of soil fill to allow for proper compaction of soil fill around the rock fragments or hard lumps as specified in Paragraph 6.2. **Oversize rock** is defined as material greater than 12 inches.
- 3.1.3 **Rock fills** are defined as fills containing no rocks or hard lumps larger than 3 feet in maximum dimension and containing little or no fines. Fines are defined as material smaller than $\frac{3}{4}$ inch in maximum dimension. The quantity of fines shall be less than approximately 20 percent of the rock fill quantity.
- 3.2 Material of a perishable, spongy, or otherwise unsuitable nature as determined by the Consultant shall not be used in fills.
- 3.3 Materials used for fill, either imported or on-site, shall not contain hazardous materials as defined by the California Code of Regulations, Title 22, Division 4, Chapter 30, Articles 9

and 10; 40CFR; and any other applicable local, state or federal laws. The Consultant shall not be responsible for the identification or analysis of the potential presence of hazardous materials. However, if observations, odors or soil discoloration cause Consultant to suspect the presence of hazardous materials, the Consultant may request from the Owner the termination of grading operations within the affected area. Prior to resuming grading operations, the Owner shall provide a written report to the Consultant indicating that the suspected materials are not hazardous as defined by applicable laws and regulations.

- 3.4 The outer 15 feet of *soil-rock* fill slopes, measured horizontally, should be composed of properly compacted *soil* fill materials approved by the Consultant. *Rock* fill may extend to the slope face, provided that the slope is not steeper than 2:1 (horizontal:vertical) and a soil layer no thicker than 12 inches is track-walked onto the face for landscaping purposes. This procedure may be utilized provided it is acceptable to the governing agency, Owner and Consultant.
- 3.5 Samples of soil materials to be used for fill should be tested in the laboratory by the Consultant to determine the maximum density, optimum moisture content, and, where appropriate, shear strength, expansion, and gradation characteristics of the soil.
- 3.6 During grading, soil or groundwater conditions other than those identified in the Geotechnical Report may be encountered by the Contractor. The Consultant shall be notified immediately to evaluate the significance of the unanticipated condition.

4. CLEARING AND PREPARING AREAS TO BE FILLED

- 4.1 Areas to be excavated and filled shall be cleared and grubbed. Clearing shall consist of complete removal above the ground surface of trees, stumps, brush, vegetation, man-made structures, and similar debris. Grubbing shall consist of removal of stumps, roots, buried logs and other unsuitable material and shall be performed in areas to be graded. Roots and other projections exceeding 1½ inches in diameter shall be removed to a depth of 3 feet below the surface of the ground. Borrow areas shall be grubbed to the extent necessary to provide suitable fill materials.
- 4.2 Asphalt pavement material removed during clearing operations should be properly disposed at an approved off-site facility or in an acceptable area of the project evaluated by Geocon and the property owner. Concrete fragments that are free of reinforcing steel may be placed in fills, provided they are placed in accordance with Section 6.2 or 6.3 of this document.

4.3 After clearing and grubbing of organic matter and other unsuitable material, loose or porous soils shall be removed to the depth recommended in the Geotechnical Report. The depth of removal and compaction should be observed and approved by a representative of the Consultant. The exposed surface shall then be plowed or scarified to a minimum depth of 6 inches and until the surface is free from uneven features that would tend to prevent uniform compaction by the equipment to be used.

4.4 Where the slope ratio of the original ground is steeper than 5:1 (horizontal:vertical), or where recommended by the Consultant, the original ground should be benched in accordance with the following illustration.

TYPICAL BENCHING DETAIL

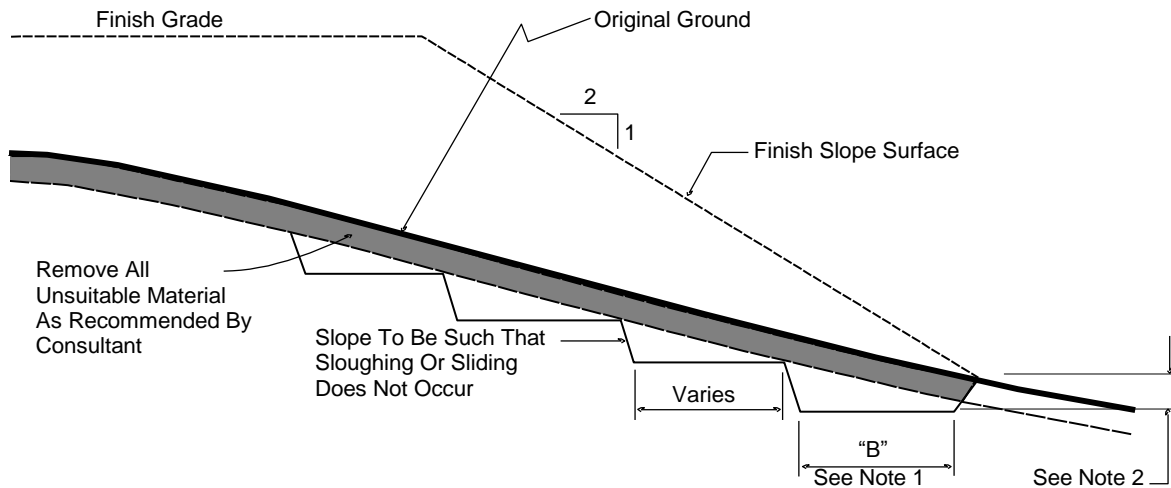

No Scale

- DETAIL NOTES:
- (1) Key width "B" should be a minimum of 10 feet, or sufficiently wide to permit complete coverage with the compaction equipment used. The base of the key should be graded horizontal, or inclined slightly into the natural slope.
 - (2) The outside of the key should be below the topsoil or unsuitable surficial material and at least 2 feet into dense formational material. Where hard rock is exposed in the bottom of the key, the depth and configuration of the key may be modified as approved by the Consultant.

4.5 After areas to receive fill have been cleared and scarified, the surface should be moisture conditioned to achieve the proper moisture content, and compacted as recommended in Section 6 of these specifications.

5. COMPACTION EQUIPMENT

- 5.1 Compaction of *soil* or *soil-rock* fill shall be accomplished by sheepsfoot or segmented-steel wheeled rollers, vibratory rollers, multiple-wheel pneumatic-tired rollers, or other types of acceptable compaction equipment. Equipment shall be of such a design that it will be capable of compacting the *soil* or *soil-rock* fill to the specified relative compaction at the specified moisture content.
- 5.2 Compaction of *rock* fills shall be performed in accordance with Section 6.3.

6. PLACING, SPREADING AND COMPACTION OF FILL MATERIAL

- 6.1 *Soil* fill, as defined in Paragraph 3.1.1, shall be placed by the Contractor in accordance with the following recommendations:
- 6.1.1 *Soil* fill shall be placed by the Contractor in layers that, when compacted, should generally not exceed 8 inches. Each layer shall be spread evenly and shall be thoroughly mixed during spreading to obtain uniformity of material and moisture in each layer. The entire fill shall be constructed as a unit in nearly level lifts. Rock materials greater than 12 inches in maximum dimension shall be placed in accordance with Section 6.2 or 6.3 of these specifications.
- 6.1.2 In general, the *soil* fill shall be compacted at a moisture content at or above the optimum moisture content as determined by ASTM D 1557.
- 6.1.3 When the moisture content of *soil* fill is below that specified by the Consultant, water shall be added by the Contractor until the moisture content is in the range specified.
- 6.1.4 When the moisture content of the *soil* fill is above the range specified by the Consultant or too wet to achieve proper compaction, the *soil* fill shall be aerated by the Contractor by blading/mixing, or other satisfactory methods until the moisture content is within the range specified.
- 6.1.5 After each layer has been placed, mixed, and spread evenly, it shall be thoroughly compacted by the Contractor to a relative compaction of at least 90 percent. Relative compaction is defined as the ratio (expressed in percent) of the in-place dry density of the compacted fill to the maximum laboratory dry density as determined in accordance with ASTM D 1557. Compaction shall be continuous over the entire area, and compaction equipment shall make sufficient passes so that the specified minimum relative compaction has been achieved throughout the entire fill.

- 6.1.6 Where practical, soils having an Expansion Index greater than 50 should be placed at least 3 feet below finish pad grade and should be compacted at a moisture content generally 2 to 4 percent greater than the optimum moisture content for the material.
 - 6.1.7 Properly compacted *soil* fill shall extend to the design surface of fill slopes. To achieve proper compaction, it is recommended that fill slopes be over-built by at least 3 feet and then cut to the design grade. This procedure is considered preferable to track-walking of slopes, as described in the following paragraph.
 - 6.1.8 As an alternative to over-building of slopes, slope faces may be back-rolled with a heavy-duty loaded sheepsfoot or vibratory roller at maximum 4-foot fill height intervals. Upon completion, slopes should then be track-walked with a D-8 dozer or similar equipment, such that a dozer track covers all slope surfaces at least twice.
- 6.2 *Soil-rock* fill, as defined in Paragraph 3.1.2, shall be placed by the Contractor in accordance with the following recommendations:
- 6.2.1 Rocks larger than 12 inches but less than 4 feet in maximum dimension may be incorporated into the compacted *soil* fill, but shall be limited to the area measured 15 feet minimum horizontally from the slope face and 5 feet below finish grade or 3 feet below the deepest utility, whichever is deeper.
 - 6.2.2 Rocks or rock fragments up to 4 feet in maximum dimension may either be individually placed or placed in windrows. Under certain conditions, rocks or rock fragments up to 10 feet in maximum dimension may be placed using similar methods. The acceptability of placing rock materials greater than 4 feet in maximum dimension shall be evaluated during grading as specific cases arise and shall be approved by the Consultant prior to placement.
 - 6.2.3 For individual placement, sufficient space shall be provided between rocks to allow for passage of compaction equipment.
 - 6.2.4 For windrow placement, the rocks should be placed in trenches excavated in properly compacted *soil* fill. Trenches should be approximately 5 feet wide and 4 feet deep in maximum dimension. The voids around and beneath rocks should be filled with approved granular soil having a Sand Equivalent of 30 or greater and should be compacted by flooding. Windrows may also be placed utilizing an "open-face" method in lieu of the trench procedure, however, this method should first be approved by the Consultant.

- 6.2.5 Windrows should generally be parallel to each other and may be placed either parallel to or perpendicular to the face of the slope depending on the site geometry. The minimum horizontal spacing for windrows shall be 12 feet center-to-center with a 5-foot stagger or offset from lower courses to next overlying course. The minimum vertical spacing between windrow courses shall be 2 feet from the top of a lower windrow to the bottom of the next higher windrow.
- 6.2.6 Rock placement, fill placement and flooding of approved granular soil in the windrows should be continuously observed by the Consultant.
- 6.3 *Rock* fills, as defined in Section 3.1.3, shall be placed by the Contractor in accordance with the following recommendations:
- 6.3.1 The base of the *rock* fill shall be placed on a sloping surface (minimum slope of 2 percent). The surface shall slope toward suitable subdrainage outlet facilities. The *rock* fills shall be provided with subdrains during construction so that a hydrostatic pressure buildup does not develop. The subdrains shall be permanently connected to controlled drainage facilities to control post-construction infiltration of water.
- 6.3.2 *Rock* fills shall be placed in lifts not exceeding 3 feet. Placement shall be by rock trucks traversing previously placed lifts and dumping at the edge of the currently placed lift. Spreading of the *rock* fill shall be by dozer to facilitate *seating* of the rock. The *rock* fill shall be watered heavily during placement. Watering shall consist of water trucks traversing in front of the current rock lift face and spraying water continuously during rock placement. Compaction equipment with compactive energy comparable to or greater than that of a 20-ton steel vibratory roller or other compaction equipment providing suitable energy to achieve the required compaction or deflection as recommended in Paragraph 6.3.3 shall be utilized. The number of passes to be made should be determined as described in Paragraph 6.3.3. Once a *rock* fill lift has been covered with *soil* fill, no additional *rock* fill lifts will be permitted over the *soil* fill.
- 6.3.3 Plate bearing tests, in accordance with ASTM D 1196, may be performed in both the compacted *soil* fill and in the *rock* fill to aid in determining the required minimum number of passes of the compaction equipment. If performed, a minimum of three plate bearing tests should be performed in the properly compacted *soil* fill (minimum relative compaction of 90 percent). Plate bearing tests shall then be performed on areas of *rock* fill having two passes, four passes and six passes of the compaction equipment, respectively. The number of passes required for the *rock* fill shall be determined by comparing the results of the plate bearing tests for the *soil* fill and the *rock* fill and by evaluating the deflection

variation with number of passes. The required number of passes of the compaction equipment will be performed as necessary until the plate bearing deflections are equal to or less than that determined for the properly compacted *soil* fill. In no case will the required number of passes be less than two.

- 6.3.4 A representative of the Consultant should be present during *rock* fill operations to observe that the minimum number of “passes” have been obtained, that water is being properly applied and that specified procedures are being followed. The actual number of plate bearing tests will be determined by the Consultant during grading.
- 6.3.5 Test pits shall be excavated by the Contractor so that the Consultant can state that, in their opinion, sufficient water is present and that voids between large rocks are properly filled with smaller rock material. In-place density testing will not be required in the *rock* fills.
- 6.3.6 To reduce the potential for “piping” of fines into the *rock* fill from overlying *soil* fill material, a 2-foot layer of graded filter material shall be placed above the uppermost lift of *rock* fill. The need to place graded filter material below the *rock* should be determined by the Consultant prior to commencing grading. The gradation of the graded filter material will be determined at the time the *rock* fill is being excavated. Materials typical of the *rock* fill should be submitted to the Consultant in a timely manner, to allow design of the graded filter prior to the commencement of *rock* fill placement.
- 6.3.7 *Rock* fill placement should be continuously observed during placement by the Consultant.

7. SUBDRAINS

- 7.1 The geologic units on the site may have permeability characteristics and/or fracture systems that could be susceptible under certain conditions to seepage. The use of canyon subdrains may be necessary to mitigate the potential for adverse impacts associated with seepage conditions. Canyon subdrains with lengths in excess of 500 feet or extensions of existing offsite subdrains should use 8-inch-diameter pipes. Canyon subdrains less than 500 feet in length should use 6-inch-diameter pipes.

TYPICAL CANYON DRAIN DETAIL

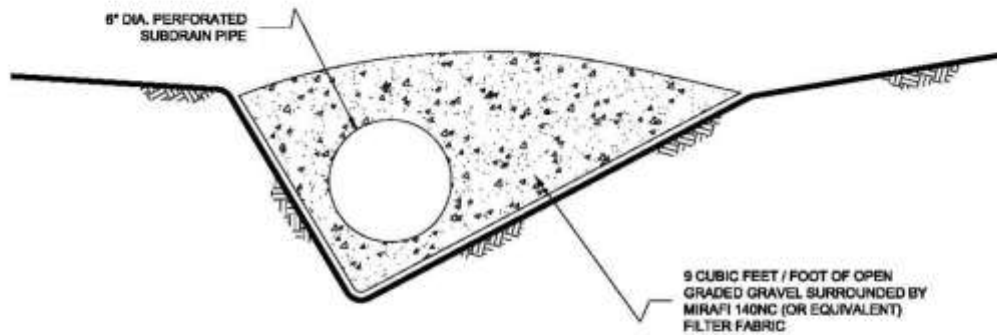
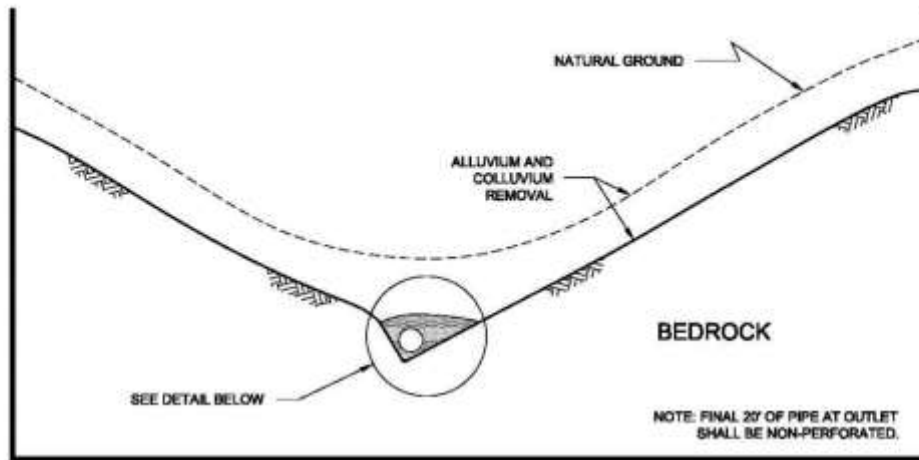

NOTES:

- 1.....6-INCH DIAMETER, SCHEDULE 80 PVC PERFORATED PIPE FOR FILLS IN EXCESS OF 100-FEET IN DEPTH OR A PIPE LENGTH OF LONGER THAN 500 FEET.
- 2.....6-INCH DIAMETER, SCHEDULE 40 PVC PERFORATED PIPE FOR FILLS LESS THAN 100-FEET IN DEPTH OR A PIPE LENGTH SHORTER THAN 500 FEET.

NO SCALE

7.2 Slope drains within stability fill keyways should use 4-inch-diameter (or larger) pipes.

7.5 Prior to outletting, the final 20-foot segment of a subdrain that will not be extended during future development should consist of non-perforated drainpipe. At the non-perforated/perforated interface, a seepage cutoff wall should be constructed on the downslope side of the pipe.

TYPICAL CUT OFF WALL DETAIL

FRONT VIEW

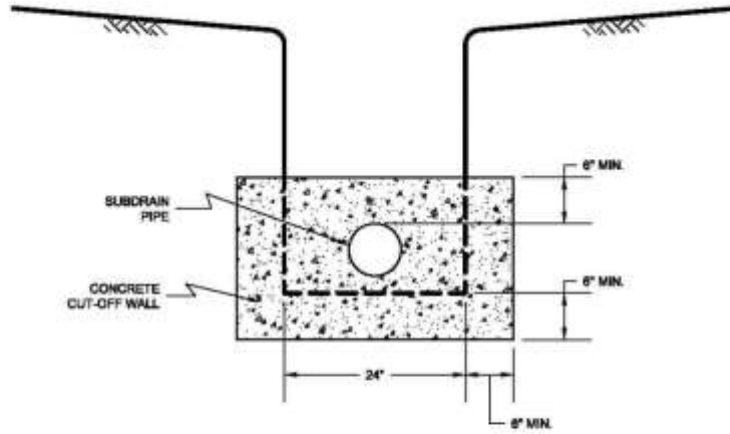

SIDE VIEW

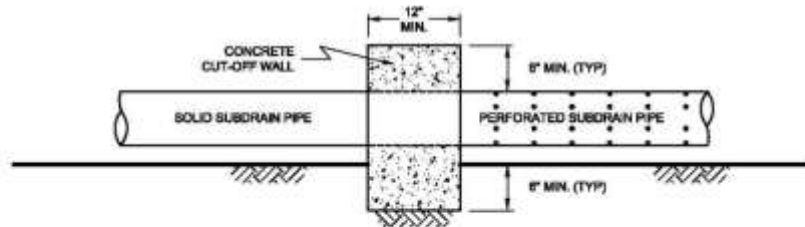

7.6 Subdrains that discharge into a natural drainage course or open space area should be provided with a permanent headwall structure.

TYPICAL HEADWALL DETAIL

FRONT VIEW

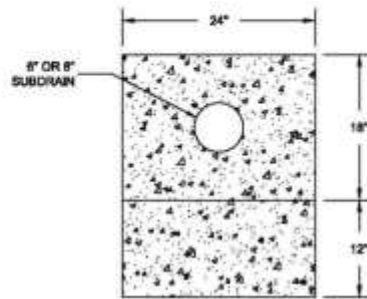

NO SCALE

SIDE VIEW

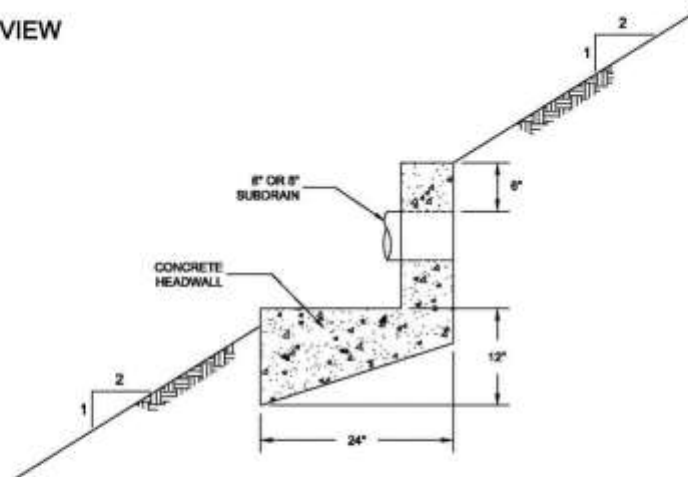

NOTE: HEADWALL SHOULD OUTLET AT TOE OF FILL SLOPE
OR INTO CONTROLLED SURFACE DRAINAGE

NO SCALE

- 7.7 The final grading plans should show the location of the proposed subdrains. After completion of remedial excavations and subdrain installation, the project civil engineer should survey the drain locations and prepare an “as-built” map showing the drain locations. The final outlet and connection locations should be determined during grading operations. Subdrains that will be extended on adjacent projects after grading can be placed on formational material and a vertical riser should be placed at the end of the subdrain. The grading contractor should consider videoing the subdrains shortly after burial to check proper installation and functionality. The contractor is responsible for the performance of the drains.

8. OBSERVATION AND TESTING

- 8.1 The Consultant shall be the Owner's representative to observe and perform tests during clearing, grubbing, filling, and compaction operations. In general, no more than 2 feet in vertical elevation of *soil* or *soil-rock* fill should be placed without at least one field density test being performed within that interval. In addition, a minimum of one field density test should be performed for every 2,000 cubic yards of *soil* or *soil-rock* fill placed and compacted.
- 8.2 The Consultant should perform a sufficient distribution of field density tests of the compacted *soil* or *soil-rock* fill to provide a basis for expressing an opinion whether the fill material is compacted as specified. Density tests shall be performed in the compacted materials below any disturbed surface. When these tests indicate that the density of any layer of fill or portion thereof is below that specified, the particular layer or areas represented by the test shall be reworked until the specified density has been achieved.
- 8.3 During placement of *rock* fill, the Consultant should observe that the minimum number of passes have been obtained per the criteria discussed in Section 6.3.3. The Consultant should request the excavation of observation pits and may perform plate bearing tests on the placed *rock* fills. The observation pits will be excavated to provide a basis for expressing an opinion as to whether the *rock* fill is properly seated and sufficient moisture has been applied to the material. When observations indicate that a layer of *rock* fill or any portion thereof is below that specified, the affected layer or area shall be reworked until the *rock* fill has been adequately seated and sufficient moisture applied.
- 8.4 A settlement monitoring program designed by the Consultant may be conducted in areas of *rock* fill placement. The specific design of the monitoring program shall be as recommended in the Conclusions and Recommendations section of the project Geotechnical Report or in the final report of testing and observation services performed during grading.
- 8.5 We should observe the placement of subdrains, to check that the drainage devices have been placed and constructed in substantial conformance with project specifications.
- 8.6 Testing procedures shall conform to the following Standards as appropriate:

8.6.1 Soil and Soil-Rock Fills:

- 8.6.1.1 Field Density Test, ASTM D 1556, *Density of Soil In-Place By the Sand-Cone Method.*

- 8.6.1.2 Field Density Test, Nuclear Method, ASTM D 6938, *Density of Soil and Soil-Aggregate In-Place by Nuclear Methods (Shallow Depth)*.
- 8.6.1.3 Laboratory Compaction Test, ASTM D 1557, *Moisture-Density Relations of Soils and Soil-Aggregate Mixtures Using 10-Pound Hammer and 18-Inch Drop*.
- 8.6.1.4. Expansion Index Test, ASTM D 4829, *Expansion Index Test*.

9. PROTECTION OF WORK

- 9.1 During construction, the Contractor shall properly grade all excavated surfaces to provide positive drainage and prevent ponding of water. Drainage of surface water shall be controlled to avoid damage to adjoining properties or to finished work on the site. The Contractor shall take remedial measures to prevent erosion of freshly graded areas until such time as permanent drainage and erosion control features have been installed. Areas subjected to erosion or sedimentation shall be properly prepared in accordance with the Specifications prior to placing additional fill or structures.
- 9.2 After completion of grading as observed and tested by the Consultant, no further excavation or filling shall be conducted except in conjunction with the services of the Consultant.

10. CERTIFICATIONS AND FINAL REPORTS

- 10.1 Upon completion of the work, Contractor shall furnish Owner a certification by the Civil Engineer stating that the lots and/or building pads are graded to within 0.1 foot vertically of elevations shown on the grading plan and that all tops and toes of slopes are within 0.5 foot horizontally of the positions shown on the grading plans. After installation of a section of subdrain, the project Civil Engineer should survey its location and prepare an *as-built* plan of the subdrain location. The project Civil Engineer should verify the proper outlet for the subdrains and the Contractor should ensure that the drain system is free of obstructions.
- 10.2 The Owner is responsible for furnishing a final as-graded soil and geologic report satisfactory to the appropriate governing or accepting agencies. The as-graded report should be prepared and signed by a California licensed Civil Engineer experienced in geotechnical engineering and by a California Certified Engineering Geologist, indicating that the geotechnical aspects of the grading were performed in substantial conformance with the Specifications or approved changes to the Specifications.

LIST OF REFERENCES

1. Boore, D. M., and G. M Atkinson (2006), Boore-Atkinson *NGA Ground Motion Relations for the Geometric Mean Horizontal Component of Peak and Spectral Ground Motion Parameters*, Report Number PEER 2007/01, May 2007.
2. Chiou, Brian S. J., and Robert R. Youngs, *A NGA Model for the Average Horizontal Component of Peak Ground Motion and Response Spectra*, preprint for article to be published in NGA Special Edition for Earthquake Spectra, Spring 2008.
3. California Department of Conservation, Division of Mines and Geology, *Probabilistic Seismic Hazard Assessment for the State of California*, Open File Report 96-08, 1996.
4. California Geological Survey, *Seismic Shaking Hazards in California*, Based on the USGS/CGS Probabilistic Seismic Hazards Assessment (PSHA) Model, 2002 (revised April 2003). 0% probability of being exceeded in 50 years.
<http://redirect.conservation.ca.gov/cgs/rghm/pshamap/pshamain.html>
5. Campbell, K. W., Y. Bozorgnia, *NGA Ground Motion Model for the Geometric Mean Horizontal Component of PGA, PGV, PGD and 5% Damped Linear Elastic Response Spectra for Periods Ranging from 0.01 to 10 s*, Preprint of version submitted for publication in the NGA Special Volume of Earthquake Spectra, Volume 24, Issue 1, pages 139-171, February 2008.
6. Geocon Incorporated, *Final Report of Testing and Observation Services During Grading, Fenton Carroll Canyon, Technology Center, Phase 1 and Phase 2 Grading, Tentative Map No. 98-1199, San Diego, California*, dated August 14, 2002 (Project No. 06127-42-06).
7. Geocon Incorporated, *Final Report of Testing and Observation Services During Grading, Fenton Carroll Canyon, Technology Center, Phase 3 Grading, Tentative Map No. 98-1199, San Diego, California*, dated June 13, 2003 (Project No. 06127-42-06).
8. Geocon Incorporated, *Report of Testing and Observation Services During Grading, Phases 2A, 2B and 3, Carroll Canyon Plant, San Diego, California*, dated June 25, 1999 (Project No. 01145-42-09E).
9. Geocon Incorporated, *Report of Testing and Observation Services During Mass Grading Operations, Carroll Canyon Material Site, Channel Fill West of Camino Santa Fe Avenue, San Diego, California*, dated October 24, 1988 (Project No. D-1145-T09).
10. Kennedy, M. P., and S. S. Tan, 2005, *Geologic Map of the San Diego 30'x60' Quadrangle, California*, USGS Regional Map Series Map No. 3, Scale 1:100,000.
11. Risk Engineering, *EZ-FRISK*, Version 7.65.
12. Unpublished reports and maps on file with Geocon Incorporated.
13. USGS computer program, *Seismic Hazard Curves and Uniform Hazard Response Spectra*.